

## Attachment 32 Project Maps

Brookings – Twin Cities

Fargo – Twin Cities

Twin Cities – La Crosse

Bemidji – Grand Rapids

Chisago – Apple River

Blue Lake Wilmarth

BRIGO





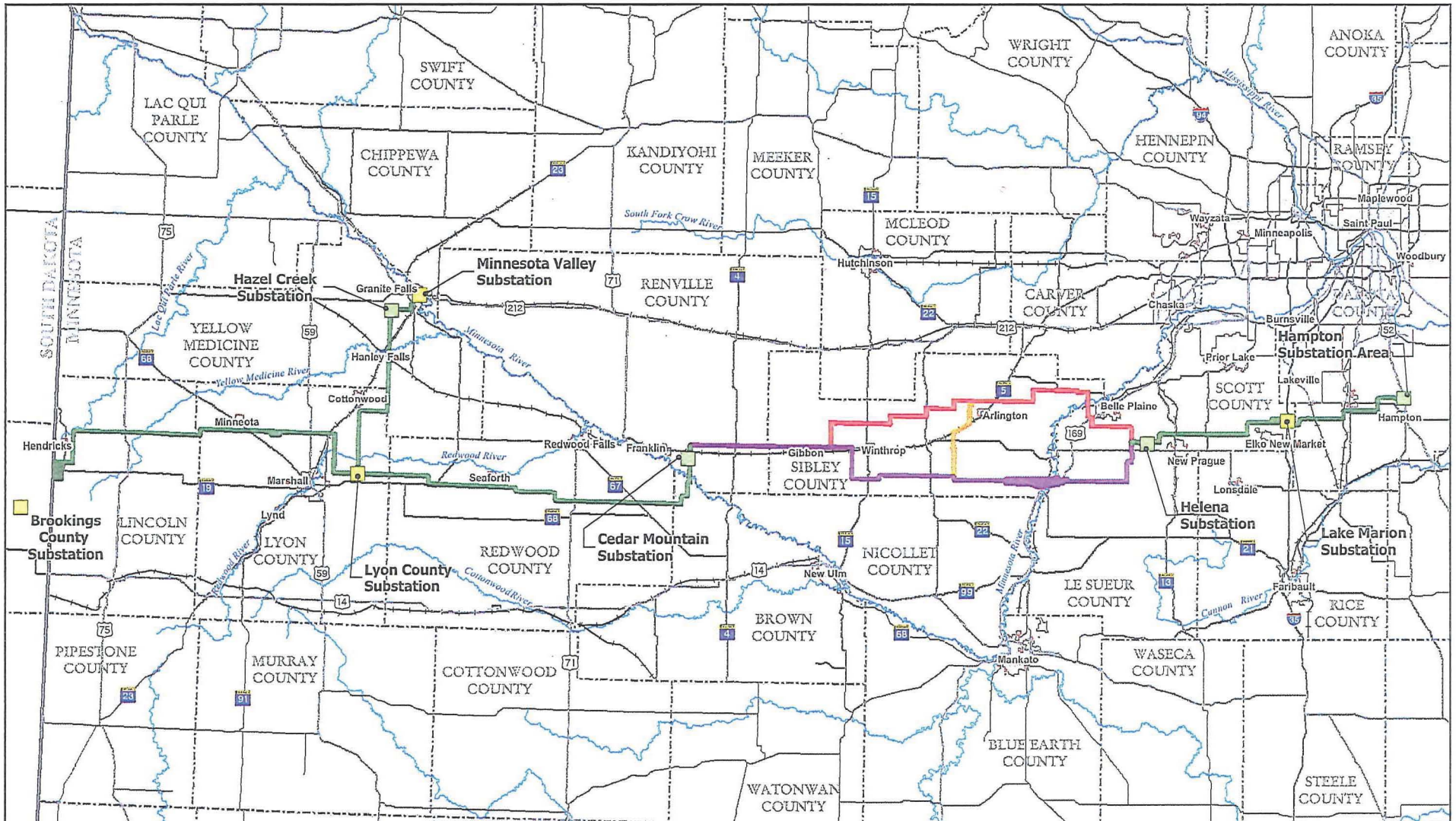

North Mankato

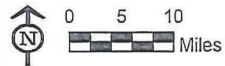
Mericourt System Upgrade



**CapX2020**  
Delivering electricity you can rely on



- |   |  |
|---|--|
|  Existing Project Substation | <b>Routes</b>  |
|  Permitted Substation        |  Approved Route                 |
|   |  Alternate Crossover            |
|   |  Crossover                      |
|   |  Modified Preferred Route (MPR) |

Overview Map  
Modified Preferred, Alternative Crossover and Crossover Route

Brookings-Hampton Route Maps  
PUC Docket Number ET2/TL-08-1474

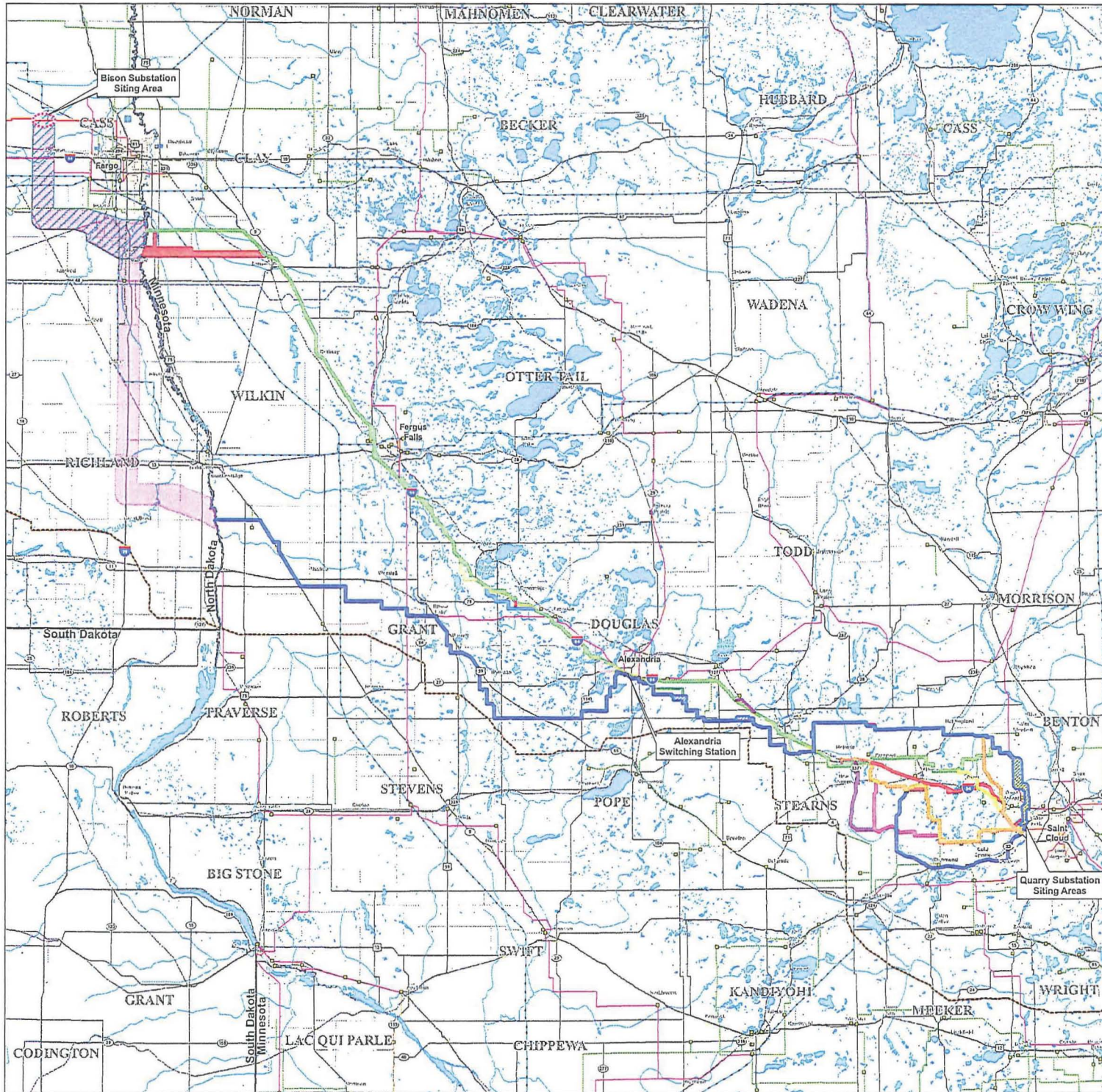

**Legend**

- Applicants' Proposed Routes
  - Route A
  - Route E
  - Option 1
  - Option 2b
  - Option 3
  - Option 6
  - Applicants' Proposed New Route Areas
- Applicant Preferred Route
- Route G
- Route H
- Public Route Options
  - Option 2c
  - Option 4
  - Option 5
  - Option 7
  - Option 8
  - Option 9
  - Option 10
  - Option 11
  - Option 12
- ATF Identified Routes
  - Route B
  - Route C
  - Route D
  - Route F
- Bison Substation Siting Area
- ND Corridor Option 1
- ND Corridor Option 2
- Existing Transmission Lines
  - Voltage (kV)
    - 400
    - 345
    - 250
    - 230
    - 115
    - 69
  - Existing Substations
- Roads
  - Interstate
  - US Highway
  - State Highway
  - County Road / Secondary Road
  - Railroad
  - River / Stream
  - Lake
- State Boundary
- County Boundary
- Municipalities

**FARGO TO ST. CLOUD  
345 kV Transmission  
Line Project**

Date: 07/26/10      Revised: 07/26/10  
 M:\GIS\Info\ARCGL\CapX\Fargo\_ArcGIS2010\MapX\_KC\_CapX\_Fargo\_Map\_DW\_Ext.mxd      Drawn by: MLTEICHERT

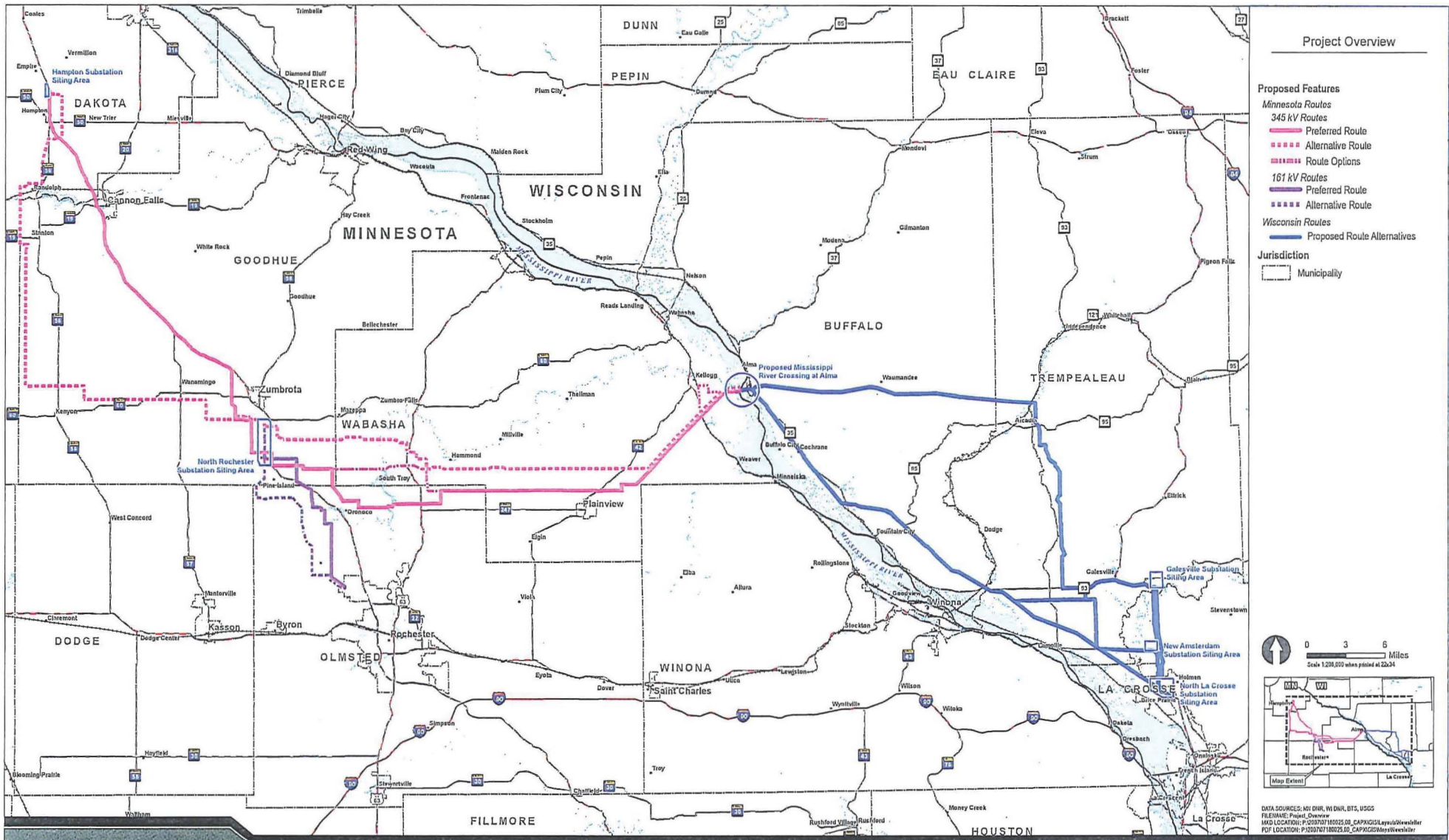

DATA SOURCES: MI DNR, WI DNR, BTS, USGS  
 FILENAME: Project\_Overview  
 MKD LOCATION: P:\030707\0025\_00\_CAPX2020\Layout\Overview.mxd  
 PLOT LOCATION: P:\030707\0025\_00\_CAPX2020\Overview.pdf

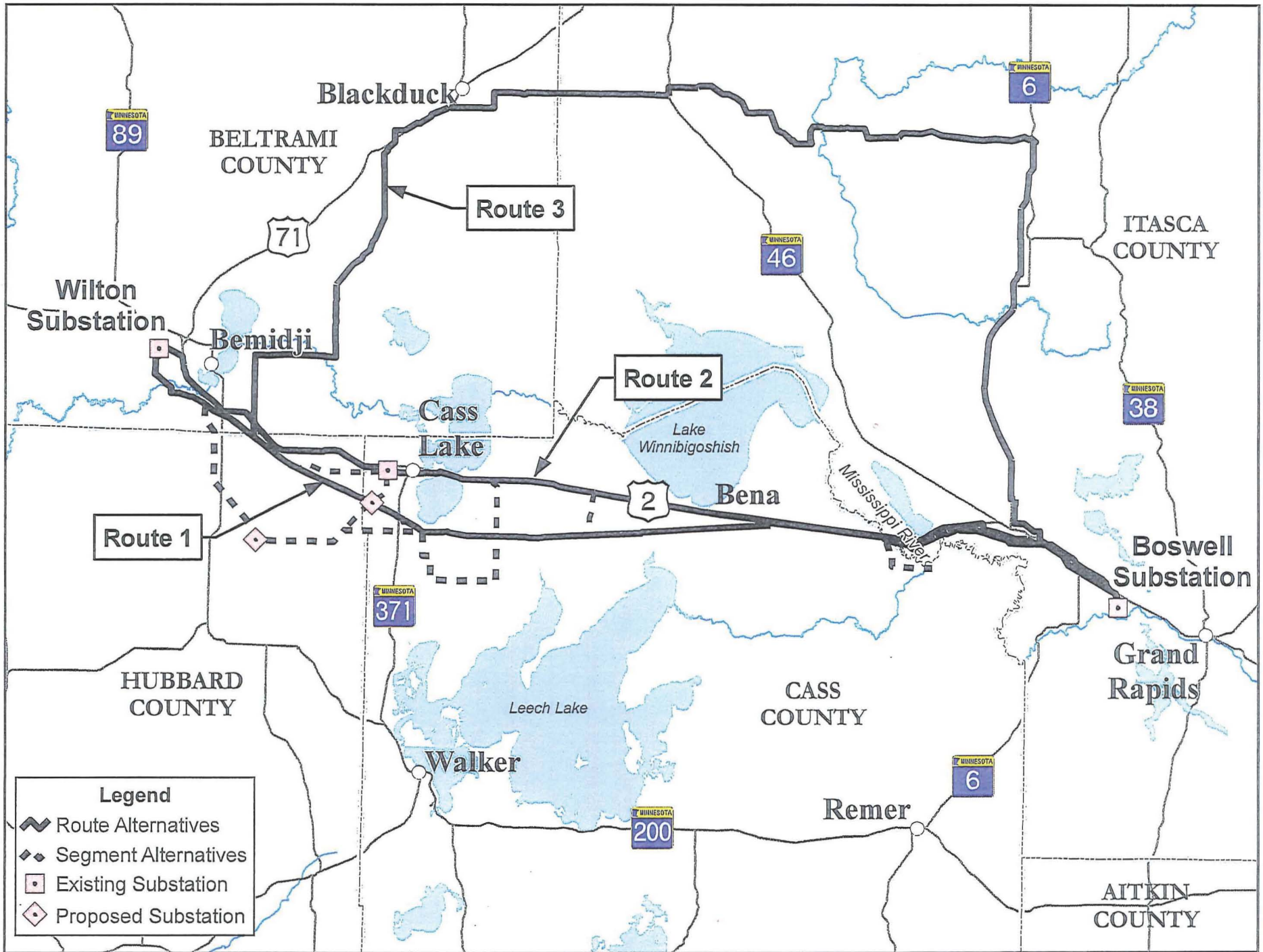

Map Document: (N:\gis\proj\06794076164\map\_docs\mxd\route\_app\_maps\figure1\_overview\_map\_vf.mxd) 11/20/2006 - 5:34:44 PM

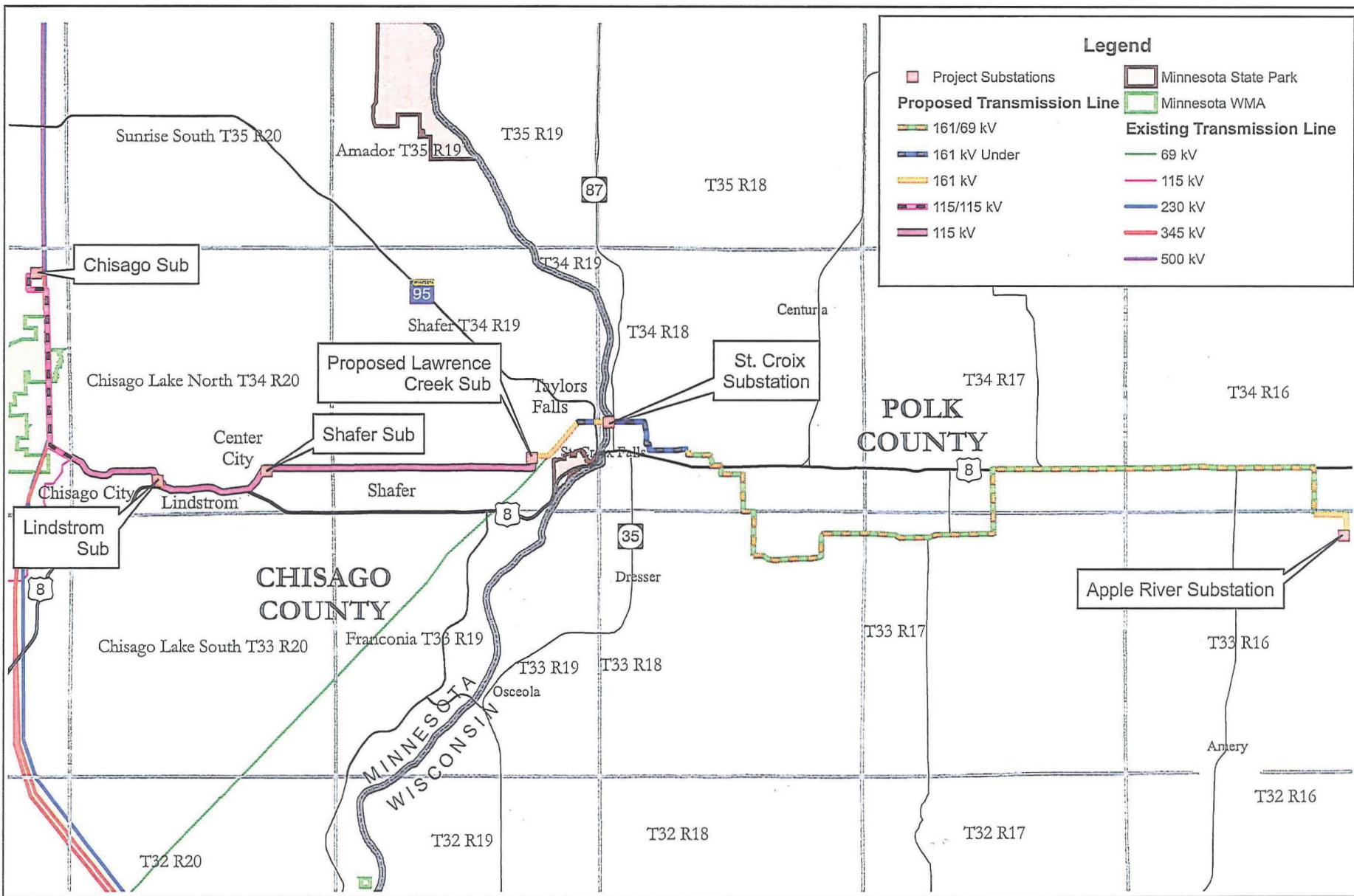

Figure 1 - Project Overview Map  
 Chisago County to Apple River 115 kV/161 kV Transmission Line Project  
 Xcel Energy  
 Chisago County, Minnesota



0 0.75 1.5  
 Miles



# Blue Lake ~ Wilmarth ~ Fieldon Series ~ Lakefield Gen ~ Lakefield Junction

## 1- Line Diagram

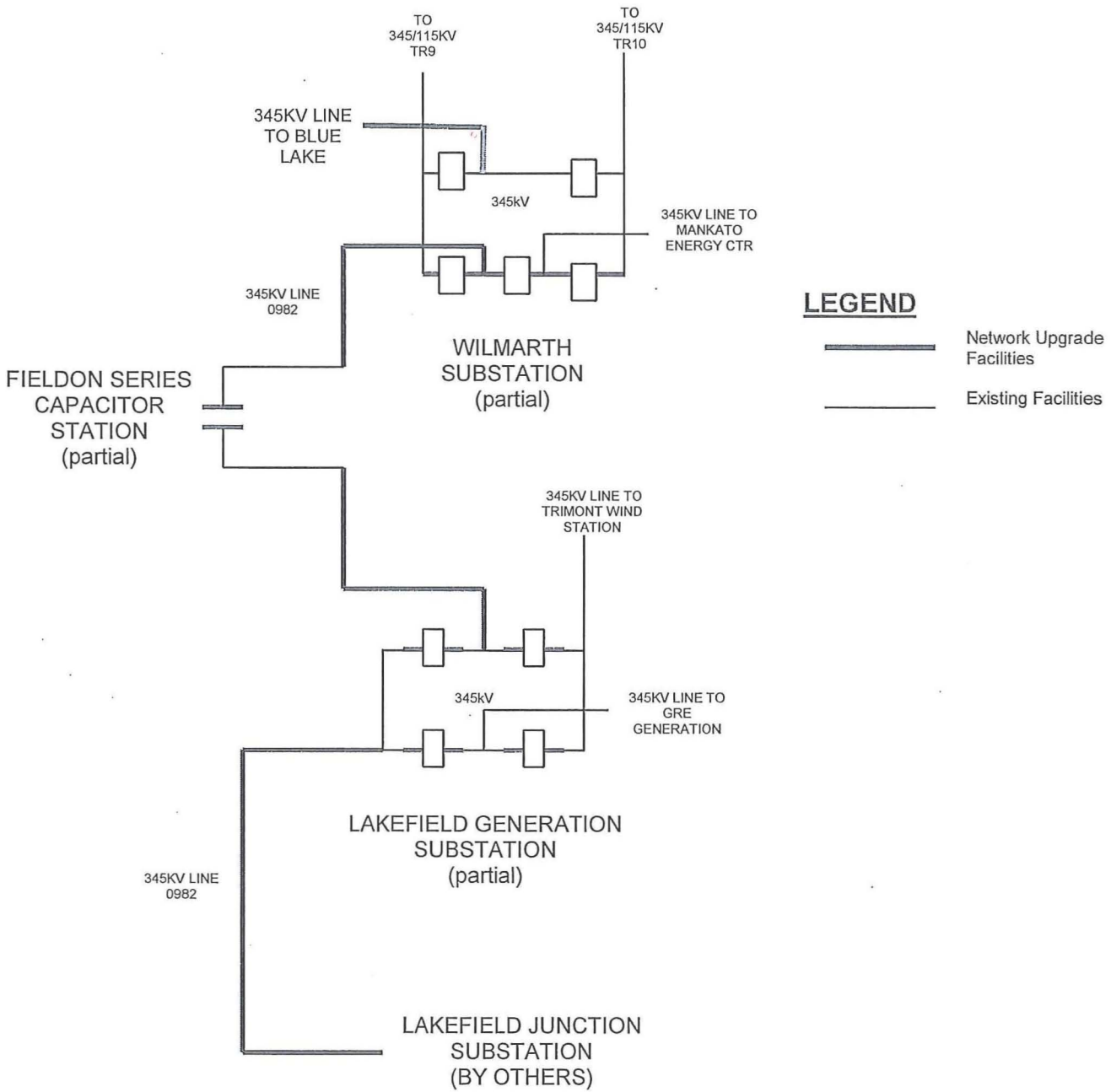

# Application to the Minnesota Public Utilities Commission for Certificates of Need

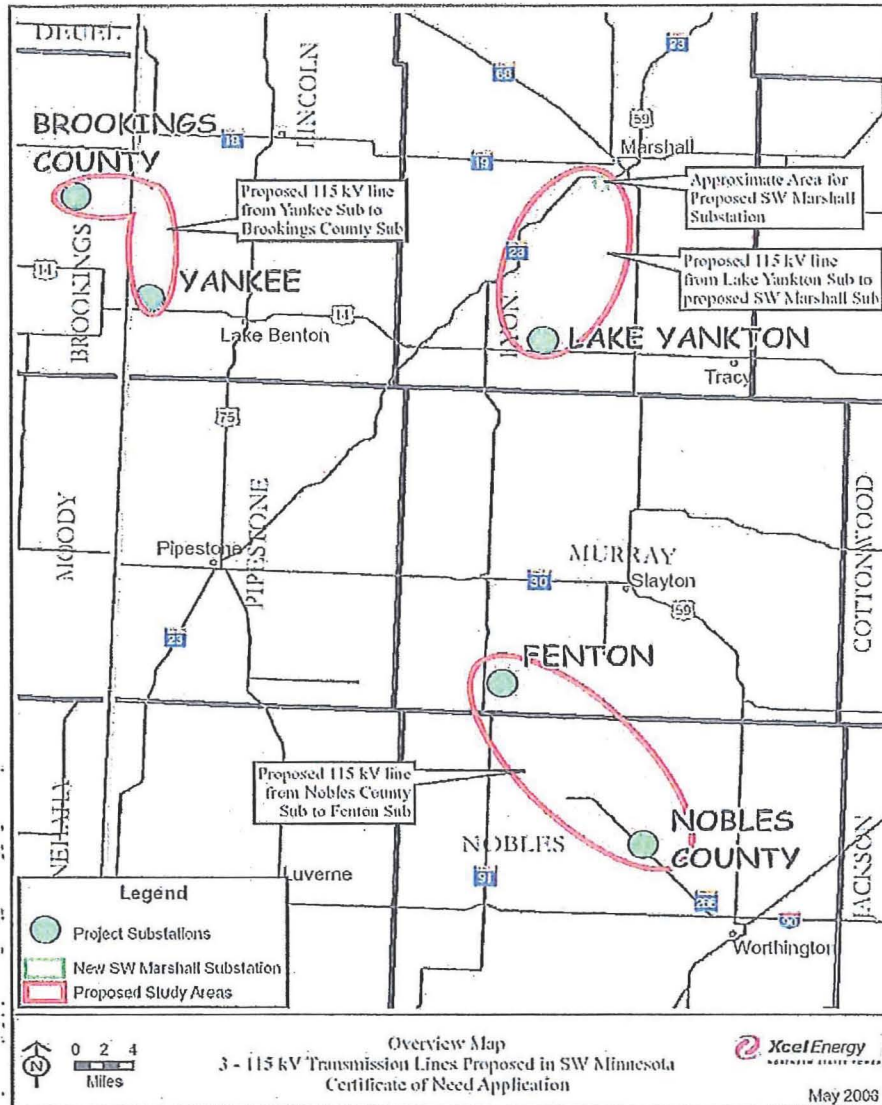

## Three 115 kV Transmission Lines Buffalo Ridge Area of Southwestern Minnesota

Docket No. E002/CN-06-154



# North Mankato Project

2.If South Helena site is approved for Helena Substation (Current Plan)  
**SCOPE**  
 "Construct Le Sueur 69 kV breaker substation (now called Kelso)  
 "Construct Helena 345/115/ 69 kV transformer substation at south Helena substation  
 "Permit and build 5 mile of 69 kV double circuit transmission line from Helena south to St. Thomas  
 "CON not required

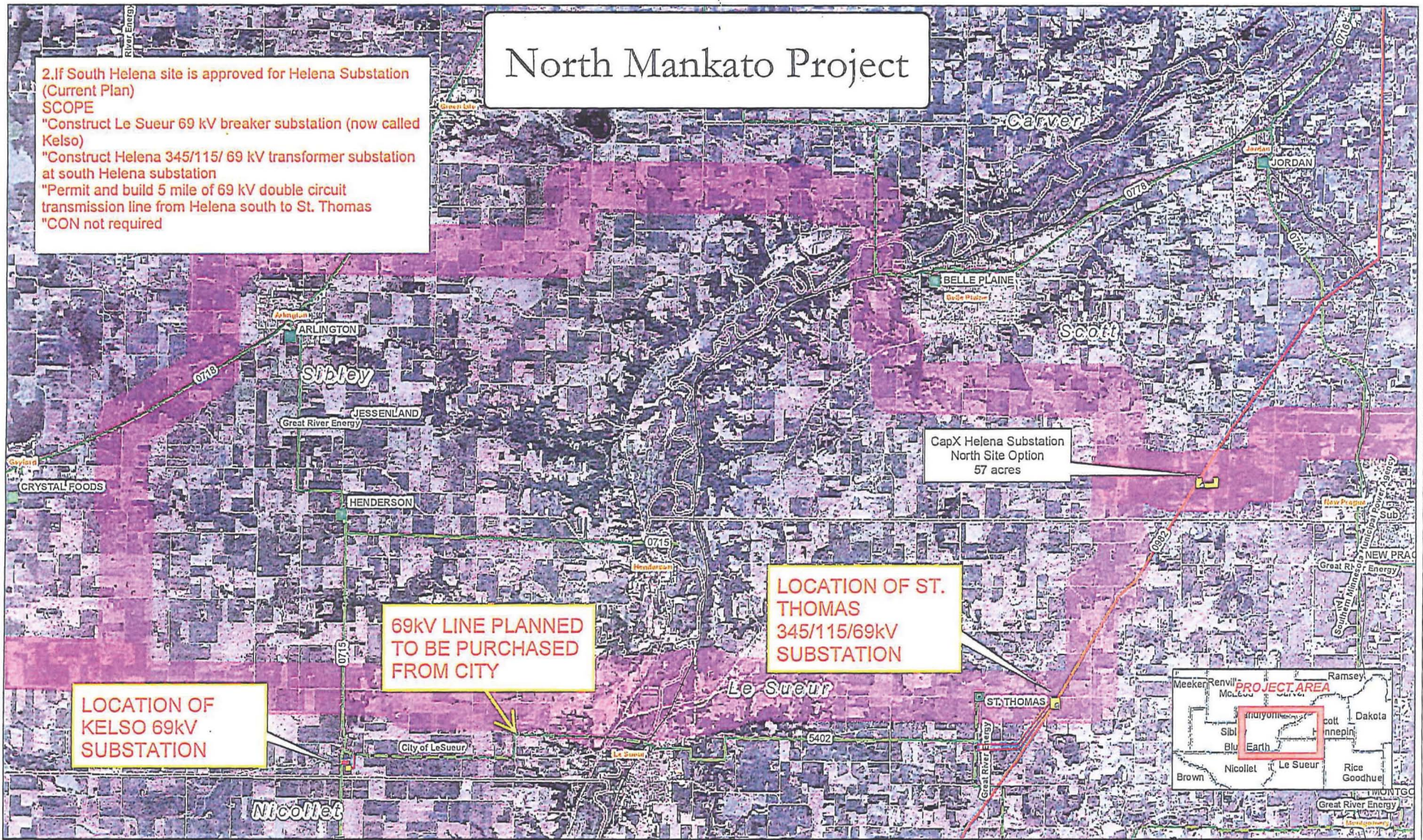

LOCATION OF KELSO 69kV SUBSTATION

69kV LINE PLANNED TO BE PURCHASED FROM CITY

LOCATION OF ST. THOMAS 345/115/69kV SUBSTATION

CapX Helena Substation North Site Option 57 acres

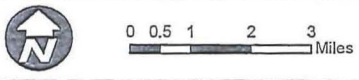

<b>Xcel Transmission</b>	<b>Foreign Transmission</b>	Xcel Substation	Proposed CapX Corridor
69 kV	69 kV	Foreign Substation	County Boundary
345 kV		Proposed Substation	Municipal Boundary

S:\SisyPark\SP\GIS\Permitting\GIS\_Analysis\PA\PA\_Files\North\_Mankato\_Proj\Proposed\_Subs.pdf

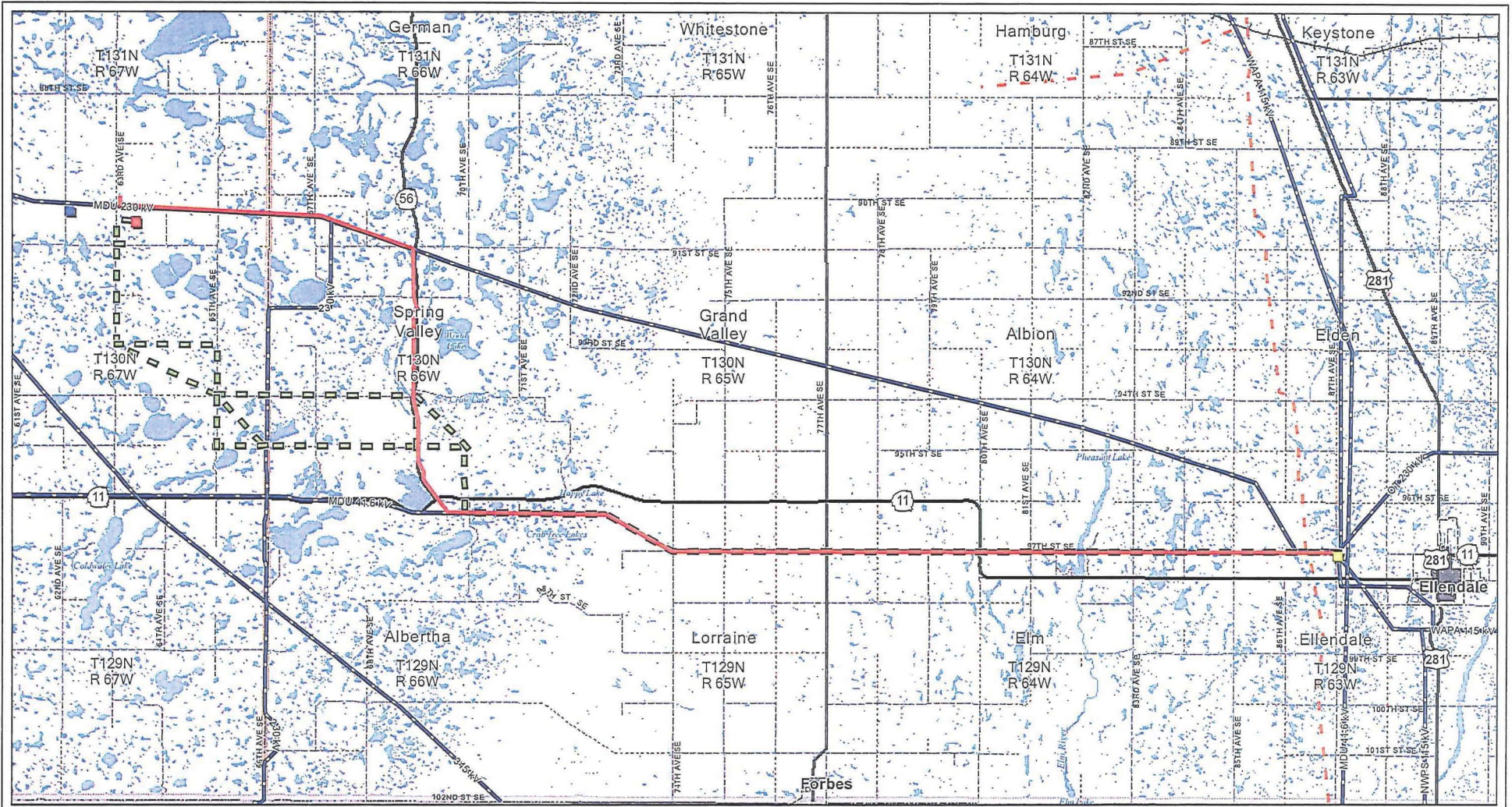

- Proposed Route
- Alternate Route
- Existing MDU Ellendale Jct. Substation
- Forbes Substation
- Existing Transmission Line
- - - Existing Gas Pipeline
- Incorporated Area
- Highway
- In-Use Railroad
- Paved
- Graded/Drained/Gravel
- - - Trail/Unimproved
- Stream
- Wetland
- County Boundary

Route Strategy Index Map  
 Montana-Dakota Utilities Co.  
 Merricourt Wind Farm to  
 Ellendale Project



Map Document: \\server\gis\and\p\project\1011map\_sov\p\ellendale\_T113N\_Pennsylvan\_Co\_incor.mxd  
 2/17/2015 10:21:13 AM