

BEFORE THE PUBLIC UTILITIES COMMISSION  
OF THE STATE OF SOUTH DAKOTA

0-0

HP 14-001

IN THE MATTER OF THE PETITION OF :  
TRANSCANADA KEYSTONE PIPELINE, LP :  
FOR ORDER ACCEPTING CERTIFICATION :  
OF PERMIT ISSUED IN DOCKET HP09-001 :  
TO CONSTRUCT THE KEYSTONE XL :  
PROJECT :

CORRECTED AMENDED REBUTTAL  
TESTIMONY OF  
HEIDI TILLQUIST

0-0

Pursuant to the Commission’s Order Granting Motion to Define Issues and Setting  
Procedural Schedule, Petitioner TransCanada Keystone Pipeline, LP, offers the following  
corrected rebuttal testimony of Heidi Tillquist.

**1. Please state your name and occupation.**

Answer: Heidi Tillquist, Director of Oil and Gas Risk Management, Stantec  
Consulting Services Inc., Fort Collins, CO.

**2. Did you provide direct testimony in this proceeding?**

Answer: Yes.

**3. To whose direct testimony are you responding in your rebuttal testimony?**

Answer: I am responding to the direct testimony of Arden Davis, Ph.D., P.E.

**4. Dr. Davis’ testimony (p.1) states that “the proposed Keystone XL pipeline would  
cross the recharge areas of several shallow aquifers in the western part of the State,**

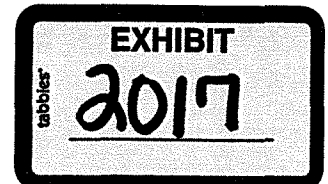

**including the Ogallala aquifer and Sand Hills type material, especially in Tripp County.”**

**Will the pipeline adversely affect these areas?**

Answer: Adverse impacts to these areas are highly unlikely. The Keystone XL pipeline crosses a number of formations in western South Dakota that outcrop in hills, stream cuts, and along mesas. Many of these formations are covered by shallow soil. In Tripp County, the pipeline crosses the Tertiary Ogallala Formation of the High Plains Aquifer system. South of the town of Buffalo, in Harding County, the pipeline crosses a section of wind-blown sand mapped as Qe (Quaternary eolian). As discussed in the State Department’s January 2014 Final Supplemental Environmental Impact Statement (FSEIS) for the Keystone XL pipeline project, *“typical recharge rates to the Ogallala Formation and associated alluvial aquifers range from 0.5 to 5 inches per year along the proposed route, with the highest recharge rates in the areas of the aquifer associated with the Sand Hills Unit”* (US Department of State [DOS] 2014). The 50-foot permanent right-of-way for the Keystone XL pipeline will occupy less than 0.1% of the total recharge area associated with the Fox Hills, Hell Creek, and Ogallala formations, as well as areas of wind-blown deposits (Qe), within counties crossed by the pipeline.

**5. Dr. Davis’ testimony (p. 2) states “the proposed pipeline also would have major stream crossings at water courses... These drainages have associated alluvial aquifers.”**

**Will the pipeline adversely affect these areas?**

Answer: Adverse impacts to these areas are highly unlikely. The Keystone XL pipeline will cross major drainages with alluvial aquifers in South Dakota. Spills at individual river crossings are rare with occurrence intervals of no more than once in 22,000 years to 830,000 years based on representative stream crossing distances (Appendix P of the FSEIS; DOS 2014). Most spills are less than 3 barrels.

The Keystone XL pipeline is designed with a minimum depth of cover of 5 feet below the bottom of waterbodies and that depth is maintained over a distance of 15 feet on each side of the waterbody, measured from the ordinary high water mark. Depth of cover is an important factor to reduce the threat of outside force damage and stream scour.

The Project's depth of cover meets or exceeds the federal requirements noted in 49 CFR Section 195.248 of 48 inches for inland bodies of water with a width of at least 100 feet from high water mark to high water mark (for normal excavation, 18 inches for rock excavation) and PHMSA Special Condition 19 regarding depth of cover.

**6. Dr. Davis' testimony (p. 2) states "in Harding County, the proposed route would cross permeable wind-blown deposits shown as Qe on Figure 4. These wind-blown deposits of silt and sand recharge from rainfall and snowmelt, they are capable of supplying water to shallow wells in the area." Will the pipeline adversely affect these areas?**

Answer: Adverse impacts to these areas are highly unlikely. The wind-blown sand south of Buffalo in Harding County has been mapped by Erickson (1956) and Petsch (1956). The deposits are mostly sand overlying the Cretaceous Hell Creek Formation. Erickson (1956) interprets these deposits to be derived from the underlying Hell Creek Formation. Rainfall falling on these sand deposits would infiltrate and form a local, temporary water-bearing zone near the base of the deposits. Because the deposits are found on bluffs and the underlying Hell Creek has a much lower permeability, it is likely that water entering the sand may form temporary springs and seeps at the base of the sand deposits, rather than migrating downward into the Hell Creek Formation.

The Keystone XL pipeline crosses these sand deposits near their eastern edge, where the deposits are thin. Examination of well logs for wells within the 1-mile buffer zone around the

pipeline indicates that none of the wells are screened in the wind-blown sands. In the area of the pipeline ROW, the wind-blown deposits are thin and not likely to be water-bearing most of the year. Based on this, along the ROW in areas of wind-blown deposits, a potential release from the pipeline would most likely not encounter permanent groundwater.

References:

Erickson, H.D., 1956. GQ 62K-045. Areal geology of the Buffalo quadrangle, scale 1:62,500 (22 x 17 in. map).

Petsch, B.C., 1956. GQ 62K-052. Areal geology of the Mouth of Bull Creek quadrangle, scale 1:62,500 (22 x 17 in. map).

**7. Dr. Davis' testimony (p. 3) states "South of the Cheyenne River in Haakon County, the proposed route would cross permeable Quaternary terrace gravels (Qt on Figure 6) and wind-blown deposits (Qe on Figure 6)...The terrace gravels and wind-blown deposits are permeable and are recharged by precipitation" and in places "are capable of supplying water to wells." Will the pipeline adversely affect these areas?**

Answer: Adverse impacts to these areas are highly unlikely. The wind-blown deposits crossed in Haakon County south of the Cheyenne River are relatively thin and not likely to form a major aquifer. Wells within 1 mile of the pipeline ROW are not screened in wind-blown material. The Cheyenne River will be crossed employing the HDD method, whereby the pipe is installed at a depth of 50 feet below the river bottom, thereby eliminating the potential for key threats including excavation damage and outside force associated with potential stream scour.

**8. Dr. Davis' testimony (p. 3) states "In Jones and Lyman counties, the proposed pipeline route would cross permeable wind-blown deposits (Qe on Figure 8) and also would**

**cross Quaternary terrace deposits north of the White River (Qt on Figure 8).” The terrace deposits have a shallow water table, are recharged by rainfall, and provide water to springs. Will the pipeline adversely affect these areas?**

Answer: Adverse impacts to these areas are highly unlikely. The wind-blown deposits crossed in Jones and Lyman counties associated with the White River are relatively thin and not likely to form a major aquifer. Wells within 1 mile of the pipeline ROW are not screened in wind-blown material. The White River will be crossed employing the HDD method, whereby the pipe is installed at a depth of 70 feet below the river bottom, thereby eliminating the potential for key threats including excavation damage and outside force associated with potential stream scour.

**9. Dr. Davis’ testimony (p. 3) states “In Tripp County...the route would cross the Ogallala aquifer (To on Figure 9)” and “wind-blown Sand Hills type material (Qe on Figure 9)...The hydrologic situation is similar to the Sand Hills of Nebraska...and therefore deserves consideration for special protection as a high consequence area. As noted by Stansbury (2011), areas with shallow groundwater that are overlain by permeable soils...pose risks of special concern because leaks could go undetected for long periods of time.” Please comment on this assertion.**

Answer: “The High Plains Aquifer area in southern Tripp County” has been identified as a hydrologically sensitive area, as defined by the Public Utilities Commission’s June 2010 Amended Final Order in Docket HP09-001. Keystone has elected to treat “hydrologically sensitive areas” as operator-defined HCAs based on a number of factors, including those identified by the Public Utilities Commission Amended Final Order Condition 35.

The Keystone XL pipeline in South Dakota was routed to reduce impacts to a number of valuable resources, including but not limited to, unconfined aquifers. Keystone has attempted to identify vulnerable aquifers through consultation with State agencies and rural water districts, as well as through the use of data provided by South Dakota Department of Environment and Natural Resources (SD DENR) (<http://denr.sd.gov/data.aspx>) and published literature. The location of unconfined aquifers is documented in the literature on the hydrogeology of South Dakota. The SD DENR website provides well logs for wells near the pipeline ROW. It is possible that, during construction and through discussion with landowners crossed by the Project, Keystone may identify shallow wells located in unconfined aquifers.

There are multiple leak detection processes that help identify small leaks, as stated in the Public Utilities Commission Amended Final Order Finding of Fact 94. While detection of a smaller leak may require additional confirmation time, examination of historical incident data confirms that small leaks do not remain undetected for long periods of time. PHMSA records (2001 through 2009) indicate that the majority of spills are 3 barrels or less, regardless of detection time. These data also indicate that the majority of spills are detected within 2 hours, with 99 percent of spills detected within 7 days. Of those spills not detected within the first 48 hours, the majority of spills were 15 barrels or less. These data do not support the contention that small leaks remain undetected for long periods of time.

**10. Dr. Davis' testimony (p. 3) states that diluted bitumen is "more corrosive than conventional crude oil transported in existing pipelines." Do you agree with this statement?**

Answer: No. A number of recent studies have investigated the claim that diluted bitumen is more corrosive to pipelines than conventional crude oil, but none found evidence of

corrosion that is unique to the transportation of diluted bitumen. Although some diluted bitumen contains higher concentrations of naphthenic acids than conventional crude oils, these compounds are only corrosive at temperatures above 200 degrees Celsius (392 degrees Fahrenheit). These temperatures do not occur in pipelines (Been 2011). The Keystone XL pipeline will not exceed temperatures of 150 degrees Fahrenheit per PHMSA Special Condition 15. Other compounds within diluted bitumen that are capable of causing corrosion, including water and sediments, occur at very low levels that are consistent with or lower than levels found in other crude oils (NAS 2013). Copies of these reports have been attached as Exhibits 1 and 2 of my testimony.

References:

Been, J. 2011. Comparison of the Corrosivity of Dilbit and Conventional Crude. Corrosion Engineering, Advanced Materials, Alberta Innovates Technology Futures. 29 pp. Internet website: [http://www.aiees.ca/media/6860/1919\\_corrosivity\\_of\\_dilbit\\_vs\\_conventional\\_crude-nov28-11\\_rev1.pdf](http://www.aiees.ca/media/6860/1919_corrosivity_of_dilbit_vs_conventional_crude-nov28-11_rev1.pdf)

National Academy of Sciences (NAS). 2013. Special Report 311: Effect of Diluted Bitumen on Crude Oil Transmission Pipelines. 110 pp.

**11. Dr. Davis' testimony (p. 3) states benzene is "known to produce leukemia in humans." Please comment on this assertion.**

Answer: While benzene is a known human carcinogen, cancer formation is associated with long-term chronic exposure, not the short-term exposure that could occur following an oil spill. For instance, a cohort study of 79 individuals exposed to benzene through their work in the Australian petroleum industry found an increased risk of leukemia following

cumulative exposures above 2 ppm-years (Glass et al. 2003). This is equivalent to being exposed to 1 ppm of benzene for 8-hours per day for two working years (500 days). Exposures such as these would not be expected to occur following a crude oil spill due to the low persistence of benzene and preventative actions such as localized evacuations. Further, emergency response personnel would evacuate the area if there were concerns for human health effects. A copy of this report has been attached as Exhibit 3 of my testimony.

Reference:

Glass, Deborah C.; Gray, Christopher N.; Jolley, Damien J.; Gibbons, Carl; Sim, Malcolm R.; Fritschi, Lin; Adams, Geoffrey G.; Bisby, John A.; Manuell, Richard. 2003. Leukemia Risk Associated with Low-Level Benzene Exposure. *Epidemiology*. 2003;14: 569-577.

**12. Dr. Davis's testimony (p. 3 and 4) discusses concerns with benzene being "transported downgradient toward receptors, such as public water-supply wells, private wells, and springs or seeps" as well as pipeline releases that have occurred in the past that have threatened groundwater supplies. How will Keystone address these concerns?**

Answer: With regard to surface water intakes, Keystone's Emergency Response Plan would identify downstream public water intakes and associated contact information. In the event of a release, Keystone would immediately notify downstream water users so that the intakes can be proactively shut down. With regard to groundwater, municipal and residential intake users would be notified through the implementation of Keystone's Emergency Response Plan. Potential impacts would take months to years to occur.

In terms of the potential effects from a release to groundwater, the following points demonstrate why a release would not threaten groundwater sources:



- The subsurface movement of petroleum hydrocarbons is very limited, moving 312 feet or less in 90 percent of the cases (Newell and Connor 1998, as presented in Exhibit 4 of my testimony). Additional studies support this plume transport distance, as presented in Exhibits 5 through 8 of my testimony.
- A plume of dissolved petroleum hydrocarbons could begin to develop if crude oil reached groundwater and was allowed to remain in contact with the groundwater for a period of months.
- The plume would then move in the direction of the groundwater; however, plume movement would be slower than for groundwater.
- The plume would form along the uppermost surface of groundwater; they do not sink within groundwater as observed with solvent plumes. As such, contamination of groundwater would be limited to the volume associated with the groundwater surface.
- Petroleum hydrocarbons are degraded by microbial communities naturally found within soils, and as a result, only highly localized effects would be expected.
- Removal of the source oil and remediation actions would help to minimize groundwater impacts further.

Based on the PHMSA pipeline incident database (2002 to 2009), only 3.8% and 3.2% of spills affected surface water or groundwater resources; however, only 0.16% of spills actually affect drinking water resources. Consequently, the possibility of a spill occurring and affecting drinking water is very remote.

Data from actual pipeline spills demonstrate that substantial leaks do not go undetected for long periods of time. Further, those spills that are not detected within the first 48 hours are typically relatively small. PHMSA records (2001 through 2009) indicate that the majority of

spills are 3 barrels or less, regardless of detection time. These data also indicate that the majority of spills are detected within 2 hours, with 99 percent of spills detected within 7 days. Of those spills not detected within the first 48 hours, the majority of spills were 15 barrels or less. In summary, large spills do not remain undetected for substantial periods of time.

Keystone will utilize an integrated leak detection system as stated in the Public Utilities Commission Amended Final Order Finding of Fact 94. Keystone also will have an Emergency Response Plan (ERP) in place to respond to incidents. The ERP contains comprehensive manuals, detailed training plans, equipment requirements, resource plans, and auditing, change management and continuous improvement processes. The Integrity Management Program (IMP) (49 CFR Section 195) and ERP will ensure Keystone will operate the pipeline in an environmentally responsible manner.

Reference:

Newell, C. J. and J. A. Connor. 1998. Characteristics of Dissolved Petroleum Hydrocarbon Plumes: Results from Four Studies. American Petroleum Institute Soil / Groundwater Technical Task Force. December 1998.

**13. Dr. Davis' testimony (p. 5) restates Stansbury (2011) concerns regarding questionable assumptions and calculations by TransCanada of expected frequency of spills.**

**Do you agree with that analysis?**

Answer: No. The majority of pipeline infrastructure in North America was constructed many decades ago at a time when the materials, coating systems, and ongoing inspection capabilities that will be used for Keystone XL were not available. Studies show the benefits of these technologies in reducing pipeline incidents. Approximately two thirds of the pipelines in the US were constructed prior to 1970. It is therefore entirely appropriate to use an

incident frequency for Keystone XL that is derived from pipelines of its class. This is corroborated by observations included in the FSEIS, “[i]t is reasonable to conclude that modern and larger-diameter pipelines would experience a lower spill rate than older pipelines. Modern pipelines have built-in measures to reduce the likelihood of a spill (e.g., modern protective coatings, SCADA monitoring)...with the application of the Special Conditions and various studies that indicate more modern pipelines are less likely to leak, it is reasonable to expect a sizable reduction in spills when compared to the historic spill record” (DOS 2014).

**14. Dr. Davis’ testimony (p. 5) restates the Stansbury (2011) argument that “worst-case spill volumes from the proposed Keystone XL pipeline are likely to be significantly larger than those estimated by TransCanada.” Do you agree with that analysis?**

Answer: No. Stansbury’s estimate of worst case discharge was based on incorrect assumptions. Keystone has calculated the worst case discharge for the Keystone XL pipeline in accordance with 49 CFR Section 194.105. The Stansbury document suggests that, because shutdown on another pipeline took longer, that increased time should be used as the shut down time assumption for the Keystone XL pipeline. The referenced Enbridge pipeline was constructed in 1969, while the Keystone XL pipeline would be constructed to meet or exceed current regulatory standards. Stansbury does not take into account that the Keystone XL pipeline is instrumented at every mainline valve, which enhances the leak detection system, and that Keystone has incorporated API’s recommended practices for computational pipeline monitoring as well as ASME’s Pipeline Personnel Qualification standards per Special Conditions 27 and 30. This makes it unlikely that Keystone operators would experience difficulty detecting a leak. Nor does he address industry information sharing or the workings of the regulatory regime, both of which serve to make it unlikely that alleged operational errors on one system are repeated on

another system. For example, TransCanada requires the pipeline be shut down if an operator cannot definitively determine the cause of an alarm within a 10-minute validation period.

In addition, Stansbury does not take into account the fact that worst case discharge is determined using a large leak that would be instantaneously detected by the leak detection system resulting in immediate initiation of shutdown procedures. Nonetheless, in determining its worst case discharge, Keystone conservatively assumed a 10-minute leak confirmation period, plus 9 minutes for pump shut down, plus a 3-minute valve closure time, for a total of 22 minutes. While detection of a smaller leak may require additional confirmation time, the small volumes released would not approach worst case discharge amounts. As discussed in my response to Question 12, it is incorrect to assume that there could be a small leak that remained undetected for an extended period of time, as suggested by the Stansbury document. A copy of this report has been attached as Exhibit 9 of my testimony.

**15. Dr. Davis' testimony (p. 5) states concerns regarding transport distance (e.g., up to 120 miles downstream) of petroleum contaminants if a release were to occur at a major water course. What is your response to these concerns?**

Answer: Dr. Davis' testimony does not account for containment and cleanup efforts by the operator that limit downstream movement. As discussed in my response to Question 12, most spills do not affect water resources. Exceptional spills that occur during flood conditions represent the worst case for downstream transport, but these do not support a 120-mile downstream transport distance. For example, following a 10,000 barrel release in 2007 from the Coffeerville Refinery in Kansas into the Verdigris River, the USEPA found no detectable concentrations of petroleum products 20 miles downstream at the closest municipal water intake. USEPA samples reported concentration of petroleum hydrocarbons to be below threshold limits

at the first sampling point, located 12 downstream miles of the spill. In 2010, an Enbridge 30-inch pipeline ruptured, spilling 19,500 barrels of oil into the Kalamazoo River system. While the majority of contamination occurred in close proximity to the source, USEPA reported that contamination had been documented in localized areas within 30 miles of the spill's origin. The material downstream was sedimented oil, which lost most of its BTEX compounds through weathering and consisted primarily of asphaltenes and other heavy molecular weight petroleum hydrocarbons. As a group, these compounds tend to have low environmental toxicity, adhere to sediments, have low bioavailability, and do not biomagnify in food chains. The BTEX values at these locations did not exceed EPA human health exposure thresholds. Sedimented oil was removed by dredging due to their environmental persistence.

As part of its Integrity Management Program and consistent with Federal pipeline safety regulations (49 CFR Section 195), Keystone has evaluated the downstream transport of a spill to identify those pipeline segments with the potential to affect High Consequence Areas.

**16. Dr. Davis testifies that diluted bitumen that sinks in water is significantly more difficult to clean up. Can you comment on that statement?**

A. TransCanada considers the potential for sinking and submerged oil as part of our Emergency Response plans and in the execution of such plans. In the unlikely event of a spill, TransCanada would work hand-in-hand with regulatory bodies to determine the correct response and remedial actions given to the specific variables of the event. While sinking crude oils do pose a greater challenge for containment and clean up compared to floating oil, the industry has emergency response containment and clean up procedures that have substantially improved, in part because of the lessons learned from the Kalamazoo spill.

Such emergency response tactics may include, but not limited to the following:

- Mechanical methods such as suction, dredging, and air bubbling.
- Non-Mechanical methods could include chemical treatment / dispersants, bio-mediation and in-situ burning.

Petroleum hydrocarbon plumes do not sink within groundwater as observed with chlorinated solvent plumes (e.g., trichloroethylene [TCE], perchloroethylene [PCE]); instead, they form along the uppermost layer of groundwater.

Therefore, contamination of groundwater would be limited to the uppermost volume associated with the groundwater surface. Petroleum hydrocarbons are naturally degraded by microbial communities naturally found within soils. As a result, petroleum hydrocarbon plumes would be expected to result in highly localized effects. Removal of the source oil and remediation actions would help to further minimize groundwater impacts.

Dated this 29 day of July, 2015.

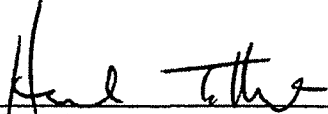
  
\_\_\_\_\_  
Heidi Tillquist

## CERTIFICATE OF SERVICE

I hereby certify that on the 29<sup>th</sup> day of July, 2015, I sent by United States first-class mail, postage prepaid, or e-mail transmission, a true and correct copy of the foregoing Corrected Amended Rebuttal Testimony of Heidi Tillquist, to the following:

Patricia Van Gerpen  
Executive Director  
South Dakota Public Utilities Commission  
500 E. Capitol Avenue  
Pierre, SD 57501  
[patty.vangerpen@state.sd.us](mailto:patty.vangerpen@state.sd.us)

Brian Rounds  
Staff Analyst  
South Dakota Public Utilities Commission  
500 E. Capitol Avenue  
Pierre, SD 57501

[brian.rounds@state.sd.us](mailto:brian.rounds@state.sd.us)  
Tony Rogers, Director  
Rosebud Sioux Tribe - Tribal Utility  
Commission  
153 South Main Street  
Mission, SD 57555  
[tuc@rosebudsiouxtribe-nsn.gov](mailto:tuc@rosebudsiouxtribe-nsn.gov)

Jane Kleeb  
1010 North Denver Avenue  
Hastings, NE 68901  
[jane@boldnebraska.org](mailto:jane@boldnebraska.org)

Terry Frisch  
Cheryl Frisch  
47591 875<sup>th</sup> Road  
Atkinson, NE 68713  
[tcfrisch@q.com](mailto:tcfrisch@q.com)

Lewis GrassRope  
PO Box 61  
Lower Brule, SD 57548  
[wisestar8@msn.com](mailto:wisestar8@msn.com)

Robert G. Allpress  
46165 Badger Road  
Naper, NE 68755  
[bobandnan2008@hotmail.com](mailto:bobandnan2008@hotmail.com)

Kristen Edwards  
Staff Attorney  
South Dakota Public Utilities Commission  
500 E. Capitol Avenue  
Pierre, SD 57501  
[kristen.edwards@state.sd.us](mailto:kristen.edwards@state.sd.us)

Darren Kearney  
Staff Analyst South Dakota Public Utilities  
Commission  
500 E. Capitol Avenue  
Pierre, SD 57501

[darren.kearney@state.sd.us](mailto:darren.kearney@state.sd.us)  
Cindy Myers, R.N.  
PO Box 104  
Stuart, NE 68780  
[csmyers77@hotmail.com](mailto:csmyers77@hotmail.com)

Byron T. Steskal  
Diana L. Steskal  
707 E. 2<sup>nd</sup> Street  
Stuart, NE 68780  
[prairierose@nntc.net](mailto:prairierose@nntc.net)

Arthur R. Tanderup  
52343 857<sup>th</sup> Road  
Neligh, NE 68756  
[atanderu@gmail.com](mailto:atanderu@gmail.com)

Carolyn P. Smith  
305 N. 3<sup>rd</sup> Street  
Plainview, NE 68769  
[peachie\\_1234@yahoo.com](mailto:peachie_1234@yahoo.com)

Amy Schaffer  
PO Box 114  
Louisville, NE 68037  
[amyannschaffer@gmail.com](mailto:amyannschaffer@gmail.com)

Benjamin D. Gotschall  
6505 W. Davey Road  
Raymond, NE 68428  
[ben@boldnebraska.org](mailto:ben@boldnebraska.org)

Elizabeth Lone Eagle  
PO Box 160  
Howes, SD 57748  
[bethcbest@gmail.com](mailto:bethcbest@gmail.com)

John H. Harter  
28125 307<sup>th</sup> Avenue  
Winner, SD 57580  
[johnharter11@yahoo.com](mailto:johnharter11@yahoo.com)

Peter Capossela  
Peter Capossela, P.C.  
Representing Standing Rock Sioux Tribe  
PO Box 10643  
Eugene, OR 97440  
[pcapossela@nu-world.com](mailto:pcapossela@nu-world.com)

Travis Clark  
Fredericks Peebles & Morgan LLP  
Suite 104, 910 5<sup>th</sup> St.  
Rapid City, SD 57701  
[tclark@ndnlaw.com](mailto:tclark@ndnlaw.com)

Jerry P. Jones  
22584 US Hwy 14  
Midland, SD 57552  
Debbie J. Trapp  
24952 US Hwy 14  
Midland, SD 57552  
[mtdt@goldenwest.net](mailto:mtdt@goldenwest.net)

Jennifer S. Baker  
Representing Yankton Sioux Tribe  
Fredericks Peebles & Morgan LLP  
1900 Plaza Dr.  
Louisville, CO 80027  
[jbaker@ndnlaw.com](mailto:jbaker@ndnlaw.com)

Louis T. (Tom) Genung  
902 E. 7<sup>th</sup> Street  
Hastings, NE 68901  
[tg64152@windstream.net](mailto:tg64152@windstream.net)

Nancy Hilding  
6300 West Elm  
Black Hawk, SD 57718  
[nhilshat@rapidnet.com](mailto:nhilshat@rapidnet.com)

Paul F. Seamans  
27893 249<sup>th</sup> Street  
Draper, SD 57531  
[jackknife@goldenwest.net](mailto:jackknife@goldenwest.net)

Viola Waln  
PO Box 937  
Rosebud, SD 57570  
[walnranh@goldenwest.net](mailto:walnranh@goldenwest.net)  
Wrexie Lainson Bardaglio  
9748 Arden Road  
Trumansburg, NY 14886  
[wrexie.bardaglio@gmail.com](mailto:wrexie.bardaglio@gmail.com)

Harold C. Frazier  
Chairman, Cheyenne River Sioux Tribe  
PO Box 590  
Eagle Butte, SD 57625  
[haroldcfrazier@yahoo.com](mailto:haroldcfrazier@yahoo.com)  
[mailto:kevinckeckler@yahoo.com](mailto:mailto:kevinckeckler@yahoo.com)

Cody Jones  
21648 US Hwy 14/63  
Midland, SD 57552  
Gena M. Parkhurst  
2825 Minnewsta Place  
Rapid City, SD 57702  
[GMP66@hotmail.com](mailto:GMP66@hotmail.com)

Joye Braun  
PO Box 484  
Eagle Butte, SD 57625  
[jmbraun57625@gmail.com](mailto:jmbraun57625@gmail.com)



Duncan Meisel  
350.org  
20 Jay St., #1010  
Brooklyn, NY 11201  
[duncan@350.org](mailto:duncan@350.org)

Bruce Ellison  
Attorney for Dakota Rural Action  
518 6<sup>th</sup> Street #6  
Rapid City, SD 57701  
[belli4law@aol.com](mailto:belli4law@aol.com)  
RoxAnn Boettcher  
Boettcher Organics  
86061 Edgewater Avenue  
Bassett, NE 68714  
[boettcherann@abbnebraska.com](mailto:boettcherann@abbnebraska.com)  
Bonny Kilmurry  
47798 888 Road  
Atkinson, NE 68713  
[bjkilmurry@gmail.com](mailto:bjkilmurry@gmail.com)  
Robert P. Gough, Secretary  
Intertribal Council on Utility Policy  
PO Box 25  
Rosebud, SD 57570  
[bobgough@intertribalCOUP.org](mailto:bobgough@intertribalCOUP.org)  
Dallas Goldtooth  
38731 Res Hwy 1  
Morton, MN 56270  
[goldtoothdallas@gmail.com](mailto:goldtoothdallas@gmail.com)  
Cyril Scott, President  
Rosebud Sioux Tribe  
PO Box 430  
Rosebud, SD 57570  
[cscott@gwtc.net](mailto:cscott@gwtc.net)  
[ejantoine@hotmail.com](mailto:ejantoine@hotmail.com)

Thomasina Real Bird  
Representing Yankton Sioux Tribe  
Fredericks Peebles & Morgan LLP  
1900 Plaza Dr.  
Louisville, CO 80027  
[trealbird@ndnlaw.com](mailto:trealbird@ndnlaw.com)

The Yankton Sioux Tribe  
Robert Flying Hawk, Chairman  
PO Box 1153  
Wagner, SD 57380  
[robertflyinghawk@gmail.com](mailto:robertflyinghawk@gmail.com)  
Thomasina Real Bird  
Attorney for Yankton Sioux Tribe  
[trealbird@ndnlaw.com](mailto:trealbird@ndnlaw.com)  
Chastity Jewett  
1321 Woodridge Drive  
Rapid City, SD 57701  
[chasjewett@gmail.com](mailto:chasjewett@gmail.com)

Bruce Boettcher  
Boettcher Organics  
86061 Edgewater Avenue  
Bassett, NE 68714  
[boettcherann@abbnebraska.com](mailto:boettcherann@abbnebraska.com)  
Ronald Fees  
17401 Fox Ridge Road  
Opal, SD 57758

Tom BK Goldtooth  
Indigenous Environmental Network (IEN)  
PO Box 485  
Bemidji, MN 56619  
[ien@igc.org](mailto:ien@igc.org)  
Gary F. Dorr  
27853 292<sup>nd</sup>  
Winner, SD 57580  
[gfdorr@gmail.com](mailto:gfdorr@gmail.com)  
Paula Antoine  
Sicangu Oyate Land Office Coordinator  
Rosebud Sioux Tribe  
PO Box 658  
Rosebud, SD 57570  
[wopila@gwtc.net](mailto:wopila@gwtc.net)  
[paula.antoine@rosebudsiouxtribe-nsn.gov](mailto:paula.antoine@rosebudsiouxtribe-nsn.gov)  
Sabrina King  
Dakota Rural Action  
518 Sixth Street, #6  
Rapid City, SD 57701  
[sabinra@dakotarural.org](mailto:sabinra@dakotarural.org)

Frank James  
Dakota Rural Action  
PO Box 549  
Brookings, SD 57006  
[fejames@dakotarural.org](mailto:fejames@dakotarural.org)

Tracey A. Zephier  
Attorney for Cheyenne River Sioux Tribe  
Fredericks Peebles & Morgan LLP  
910 5<sup>th</sup> Street, Suite 104  
Rapid City, SD 57701  
[tzephier@ndnlaw.com](mailto:tzephier@ndnlaw.com)

Matthew Rappold  
Rappold Law Office  
on behalf of Rosebud Sioux Tribe  
PO Box 873  
Rapid City, SD 57709  
[matt.rappold01@gmail.com](mailto:matt.rappold01@gmail.com)

Kimberly E. Craven  
3560 Catalpa Way  
Boulder, CO 80304  
[kimecraven@gmail.com](mailto:kimecraven@gmail.com)  
Mary Turgeon Wynne  
Rosebud Sioux Tribe - Tribal Utility  
Commission  
153 S. Main Street  
Mission, SD 57555  
[tuc@rosebudsiouxtribe-nsn.gov](mailto:tuc@rosebudsiouxtribe-nsn.gov)

Robin S. Martinez  
Dakota Rural Action  
Martinez Madrigal & Machicao, LLC  
616 West 26<sup>th</sup> Street  
Kansas City, MO 64108  
[robin.martinez@martinezlaw.net](mailto:robin.martinez@martinezlaw.net)  
Paul C. Blackburn  
4145 20<sup>th</sup> Avenue South  
Minneapolis, MN 55407  
[paul@paulblackburn.net](mailto:paul@paulblackburn.net)

April D. McCart  
Representing Dakota Rural Action  
Certified Paralegal  
Martinez Madrigal & Machicao, LLC  
616 W. 26<sup>th</sup> Street  
Kansas City, MO 64108  
[april.mccart@martinezlaw.net](mailto:april.mccart@martinezlaw.net)

Joy Lashley  
Administrative Assistant  
SD Public Utilities Commission  
[joy.lashley@state.sd.us](mailto:joy.lashley@state.sd.us)  
Eric Antoine  
Rosebud Sioux Tribe  
PO Box 430  
Rosebud, SD 57570  
[ejantoine@hotmail.com](mailto:ejantoine@hotmail.com)

WOODS, FULLER, SHULTZ & SMITH P.C.

By /s/ James E. Moore  
William Taylor  
James E. Moore  
PO Box 5027  
300 South Phillips Avenue, Suite 300  
Sioux Falls, SD 57117-5027  
Phone (605) 336-3890  
Fax (605) 339-3357  
Email [James.Moore@woodsfuller.com](mailto:James.Moore@woodsfuller.com)  
Attorneys for Applicant TransCanada

## EXHIBITS

- EXHIBIT 1: Been, J., Comparison of the Corrosivity of Dilbit and Conventional Crude (2011).
- EXHIBIT 2: National Academy of Sciences (NAS), Special Report 311: Effect of Diluted Bitumen on Crude Oil Transmission Pipelines (2013).
- EXHIBIT 3: Glass, et al., Leukemia Risk Associated with Low-Level Benzene Exposure (2003).
- EXHIBIT 4: Newell, C.J. and Connor, J.A., Characteristics of Dissolved Petroleum Hydrocarbon Plumes: Results from Four Studies (1998).
- EXHIBIT 5: Kamath, R., et al., Use of Long-Term Monitoring Data to Evaluate Benzene, MTBE, and TBA Plume Behavior in Groundwater at Retail Gasoline Sites (2012).
- EXHIBIT 6: Connor, J., et al., Review of Quantitative Surveys of the Length and Stability of MTBE, TBA, and Benzene Plumes in Groundwater at UST Sites (2015).
- EXHIBIT 7: Ruiz-Aguilar, G., et al., A Comparison of Benzene and Toluene Plume Lengths for Sites Contaminated with Regular vs. Ethanol-Amended Gasoline (2003).
- EXHIBIT 8: Shih, T., et al., Evaluation of the Impact of Fuel Hydrocarbons and Oxygenates on Groundwater Resources (2004).
- EXHIBIT 9: Kothari, Bajnok, Tillquist, Keystone XL Project Risk Analysis Response to U.S. Department of State Request.



## **Comparison of the Corrosivity of Dilbit and Conventional Crude**

Prepared for:  
Dr. John Zhou

Alberta Innovates Energy and  
Environment Solutions

Prepared by:  
Jenny Been, PEng, Ph.D., PMP  
Corrosion Engineering, Advanced  
Materials, AITF

Reviewed by:  
John Wolodko, PEng, Ph.D.  
Advanced Materials, AITF

Copyright © 2011  
Alberta Innovates – Technology Futures

September 2011  
2480002



## NOTICE

1. This Report was prepared as an account of work conducted at the Alberta Innovates Technology Futures (“AITF”) on behalf of Alberta Innovates Energy and Environment Solutions (“AIEES”). All reasonable efforts were made to ensure that the work conforms to accepted scientific, engineering and environmental practices, but AITF makes no other representation and gives no other warranty with respect to the reliability, accuracy, validity or fitness of the information, analysis and conclusions contained in this Report. Any and all implied or statutory warranties of merchantability or fitness for any purpose are expressly excluded. AIEES acknowledges that any use or interpretation of the information, analysis or conclusions contained in this Report is at its own risk. Reference herein to any specified commercial product, process or service by trade-name, trademark, manufacturer or otherwise does not constitute or imply an endorsement or recommendation by AITF.
2. Any authorized copy of this Report distributed to a third party shall include an acknowledgement that the Report was prepared by AITF and shall give appropriate credit to AITF and the authors of the Report.
3. Copyright AITF 2011. All rights reserved.

## EXECUTIVE SUMMARY

Pipeline expansions for the transportation of Canadian crude to refining markets in the United States are currently under regulatory review. The transported oil originates primarily from the Alberta oil sands and consists of diluted bitumen, also referred to as dilbit. Alberta Innovates – Technology Futures completed a project for Alberta Innovates – Energy and Environment Solutions reviewing the current status on the corrosivity of dilbit in pipelines as compared to conventional or ‘non-oil sands derived’ crude oil.

It has been suggested that dilbit has higher acid, sulfur, and chloride salts concentrations, as well as higher concentrations of more abrasive solids. It is furthermore suggested that dilbit transmission pipelines operate at higher operating temperatures compared with conventional crude, which would make the dilbit more corrosive, thus leading to a higher failure rate than observed for pipelines transporting conventional crude. This review examines these concerns in light of the properties of dilbit in comparison with conventional oils. In addition, statistical data are presented to show if the concerns are supported by operating experience.

Conventional crude and dilbit are subject to quality control measures and regulation. Pipeline operators employ further measures during transportation to manage and control the quality of delivered crude. Alberta crude quality information is available online and accessible to the public. The properties of heavy, medium, and light conventional Alberta crude oils were compared with three dilbit and one dilsynbit crude.

Whereas two of the four dilbit crudes displayed a slightly higher naphthenic acid and sulfur concentration than the conventional Alberta heavy crudes, there are conventional crudes on the market that have displayed higher values yet. The chloride salt concentrations were either comparable or lower than all grades of conventional crude. Naphthenic acid, sulfur, and chloride salt concentrations can result in corrosion at temperatures greater than 200 C at refineries, where mitigation is addressed through upgrading of materials and the use of inhibitors. At the much lower pipeline transportation temperatures, the compounds are too stable to be corrosive and some may even decrease the corrosion rate.

The sediment levels of the dilbit crudes were comparable to or lower than the conventional crudes, except for a dilsynbit crude, which showed more than double the quantity of solids than most other crudes, but was still well below the limit set by regulatory agencies and industry. The solids size distribution is unknown as is the role of larger size solids in the formation of pipeline deposits. Erosion corrosion was found to be improbable and erosion, if present, is expected to be gradual and observed by regular mitigation practices.

The dilbit viscosities are comparable to those of heavy conventional crudes, where the viscosity is controlled and adjusted for temperature through the addition of diluent. The

resulting dilbit viscosity supports acceptable operating temperatures, which will be monitored at and downstream of the pumping stations.

Adjustment of the Alberta and U.S. pipeline failure statistics to compare similar crude oil pipeline systems on an equivalent basis indicated that the Alberta systems (with a large percentage of dilbit lines) experienced comparable internal corrosion failure rates than the U.S. systems (predominantly conventional crude lines).

Pipeline steel wet by oil does not corrode. The basic sediment and water (BS&W) content of crude oil transmission pipelines is limited to 0.5 volume percent. This water is primarily present as a stable emulsion, maintaining an oil wet pipe, protected from corrosion. Pitting corrosion has been observed underneath sludge deposits. These deposits are a mix of sand and clay particles, water, and oil products. The corrosivity of these sludges varies but seems to be linked to water content, which can exceed 10%, and large bacterial populations. The sludge deposition mechanism and the contributions of each of its components to its corrosivity are not clear. Sludge deposition and similar underdeposit corrosion is not unique to dilbit lines and also has been observed in pipelines transporting conventional crudes.

This review has indicated that the characteristics of dilbit are not unique and are comparable to conventional crude oils. Additional work is recommended in areas of sludge formation, deposition, and underdeposit corrosion. It is further recommended to expand the current crude oil property database to include downstream qualities, as well as information on H<sub>2</sub>S concentration, asphaltene and water content, and viscosity. Finally, it is recommended that better statistics be made publicly available with separate information on dilbit and conventional crude oil pipelines as well as for upstream gathering lines and transmission pipelines.

## TABLE OF CONTENTS

Notice	ii
Executive Summary	iii
<b>1.0 INTRODUCTION.....</b>	<b>6</b>
<b>2.0 OBJECTIVES.....</b>	<b>7</b>
<b>3.0 CURRENT CONCERNS .....</b>	<b>7</b>
<b>4.0 QUALITY CONTROL OF DILBIT PROPERTIES.....</b>	<b>8</b>
<b>5.0 DILBIT AND CONVENTIONAL CRUDE OIL PROPERTIES .....</b>	<b>14</b>
5.1 Naphthenic acids	14
5.2 Sulphur content	14
5.3 Chlorides	15
5.4 Sediments	15
5.5 API gravity and viscosity	16
5.6 Other properties for consideration	16
5.6.1 <i>Heavy metals: nickel and vanadium</i>	17
5.6.2 <i>Total C4s and C5s</i>	17
5.6.3 <i>Total MCR</i>	17
<b>6.0 INTERNAL PIPELINE CORROSION IN WATER-WET CONDITIONS .....</b>	<b>17</b>
<b>7.0 INTERNAL CORROSION OF DILBIT TRANSMISSION PIPELINES .....</b>	<b>18</b>
7.1 Presence of Water	19
7.2 Asphaltenes	19
7.3 Emulsified water droplets	20
7.4 Pipeline sediment and sludge formation	21
7.5 Underdeposit corrosion	21
7.6 Erosion and Erosion Corrosion	23
<b>8.0 TEMPERATURE EFFECTS.....</b>	<b>23</b>
8.1 The effect of temperature on the internal corrosion rate	23
8.2 The effect of temperature on external stress corrosion cracking	24
<b>9.0 SUMMARY.....</b>	<b>24</b>
<b>10.0 RECOMMENDATIONS.....</b>	<b>24</b>
<b>11.0 REFERENCES.....</b>	<b>26</b>



## 1.0 INTRODUCTION

TransCanada Pipeline's (TCPL's) \$13 billion Keystone pipeline system will provide a secure and growing supply of Canadian crude oil to the largest refining markets in the United States. The second Phase of this project has been completed in February 2011, enabling the transport of 591,000 barrels of oil per day from Hardisty, Alberta to Cushing, Oklahoma, and Patoka, Illinois. Phases III and IV will increase the pipeline's capacity to 1.3 million barrels of oil per day to major refineries in the Houston area. These latter two phases are under regulatory review. The transported oil primarily originates from the oil sands. Crude or bitumen obtained from the oil sands is too viscous to transport by pipeline and needs to be diluted with diluent, hence the name 'dilbit.' In the context of this report, conventional oil refers to 'non-oil sands derived' crude oil.

The same month that TCPL completed Phase II of the Keystone pipeline system, a report was issued by a group of environmental action groups on Tar Sands Pipeline Safety Risks [1]. The report contains many damaging statements to the use of dilbit, most notably that "diluted bitumen is more corrosive than conventional or crude products and is more likely to result in pipeline failures," and that "Alberta pipelines have had a higher failure rate than similar U.S. pipelines due to leaks caused by internal corrosion from transportation of diluted bitumen (dilbit)." The ERCB responded within hours of the release of the report and twice on the same day with news releases responding to 'falsehood' of the report's statements [2].

Environmental groups opposed to the pipelines continue to find material to fuel their concerns: the more than 800,000 gallons of oil spilled into the Kalamazoo River in Michigan last year came from the Cold Lake oil sands region, and the Exxon Mobil spill of 42,000 barrels of oil in the Yellowstone River may have contained dilbit. Protestors against the Keystone pipeline are gathering in demonstrations across North America leading to mass arrests and drawing widespread attention.

The arguments of these environmental groups don't go unheard with congressmen and other government officials, who have iterated reported statements and concerns [3]. The United States Department of States (DOS) has spent the last three years in review with the industry, scientific community, and other interest parties (including numerous public meetings), evaluating the purpose and need for the Project (pipeline), alternatives, and the associated potential environmental impacts. The result was issued on August 26, 2011 in a Final Environmental Impact Statement (FEIS), a comprehensive, detailed volume of work that is available to the public [4]. Public hearings were held and online comments were accepted.

The US Department of Transportation's (DOT) Pipeline and Hazardous Materials Safety Administration (PHMSA) administers the national regulatory program to ensure the safe transportation of hazardous materials by pipeline. In February 2011, PHMSA issued 57 Project-specific Special Conditions above and beyond the requirements of the pipeline code for the Keystone pipeline [Appendix U, 4]. In a news release on August 26, TCPL stated that they are pleased with the FEIS, which reaffirmed the environmental integrity of the project and concluded that oil sands derived crude oil does not have unique characteristics that would suggest the potential of higher corrosion rates during pipeline transportation. The company noted that incorporation of the 57 Special Conditions would result in a pipeline with a greater degree of safety than typical domestic pipelines.

Despite the review completed by the US DOS, there still exists confusion with regard to the corrosivity of dilbit versus that of conventional oil. The 57 Special Conditions are not sufficient according to the environmental groups opposed to the pipelines. Alberta Energy Minister Ron Liepert considers it a challenge of combating emotion with facts, and assures that the facts could be obtained without too much difficulty [5]. Concerns continue to surface in the media [6] and in the face of few factual studies and a strong confidence in the ERCB tracking statistics that dilbit is not more corrosive than conventional oil, corrosivity claims continue to be used as fuel by certain environmental groups. The current work will review the current status of information and concerns regarding the corrosivity of dilbit in pipeline transportation as compared to conventional crude oil. The focus of this work will be on transmission or transportation pipelines that transport oil over large distances to delivery points such as refineries and are subject to tariff quality specifications that include a limitation on the total amount of allowable sediment and water of 0.5 percent by volume. The Keystone pipeline is such a pipeline.

## 2.0 OBJECTIVES

To provide a confidential report including:

- Summary of the current concerns
- Status review on the corrosivity of dilbit in pipeline transportation as compared to conventional oil and
- Description and analysis of the current scientific information, assessing the validity of the concerns, identifying significant gaps, and recommending follow-up studies.

## 3.0 CURRENT CONCERNS

The Natural Resources Defense Council [1] has done an excellent job in summarizing the concerns presented by interest groups regarding the corrosivity of dilbit as compared to conventional crude oil and many of the same concerns have been expressed in other conversations and publications. The following is a summary of claims with regard to dilbit corrosivity [1] and include a few corrosion concerns from comments to the FEIS [4].

It has been suggested that dilbit may be more corrosive to pipeline systems than conventional crude and the following claims have been made:

- Claim #1: Dilbit contains fifteen to twenty times higher corrosive acid concentrations than conventional crude oil [1].
- Claim #2: Dilbit contains five to ten times as much sulfur as conventional crudes; the additional sulfur can lead to the weakening or embrittlement of pipelines [1].
- Claim #3: Dilbit has a high concentration of chloride salts, which can lead to chloride stress corrosion cracking in high temperature pipelines [1].
- Claim #4: Oil sands crude contains higher quantities of abrasive quartz sand particles than conventional crude, which can erode the pipelines [1].

- Claim #5: It has been suggested that dilbit could be up to seventy times more viscous than conventional crude oil. It has been claimed that the increase in viscosity creates higher temperatures as a result of friction [1].
- Claim #6: The Alberta pipeline system has had approximately sixteen times as many spills due to internal corrosion than the U.S. system, indicating that the dilbit is much more corrosive than the conventional oil that is primarily flowing through U.S. lines [1].
- Claim #7: An increased risk of internal corrosion may be related to the sediment composition of dilbits and specific sediment characteristics, including particle hardness and size distribution [4].
- Claim #8: A combination of chemical corrosion and physical abrasion can dramatically increase the rate of pipeline deterioration [1].
- Claim #9: As a result of the high viscosity of dilbit, pipelines operate at temperatures up to 158 F, whereas conventional crude pipelines generally run at ambient temperatures. The high temperature would significantly increase the corrosion rate which doubles with every 20 degree Fahrenheit increase in temperature [1].
- Claim #10: Dilbit pipelines may be subject to a higher incidence of external stress corrosion cracking [4].

These claims will be examined in light of the properties of dilbit in comparison with conventional oils. In addition, statistical data are presented to show if the concerns are supported by operating experience.

#### 4.0 QUALITY CONTROL OF DILBIT PROPERTIES

Any discussion on the different risks and hazards of the transportation of dilbit versus that of conventional crude should start with a consideration of the differences in properties of the oils that enter the transmission pipeline system and how these properties are controlled and managed by the industry using regulatory and industrial quality assurance guidelines.

The Canadian Association of Petroleum Producers (CAPP) has established a crude oil committee to work with regulated segments of the industry such as transportation, storage, and market access. Crude oil quality subcommittees address specific crude quality issues and issues inherent in refining and shipping these crudes. Priorities that are addressed on an ongoing basis include [14]:

- management of oil quality issues to ensure maximum value amid growing crude oil types and blends, specifically,
  - condensate quality specifications and quality recommendations
  - new crude approvals process
  - quality test method improvements

One significant effort pertains to the definition of quality specifications of the condensate stream managed by Enbridge, also referred to as CRW [7]. This condensate stream consists of field condensates, ultra-light sweet crudes, and refinery and upgrader naptha streams from several supply sources. Historically, this condensate commodity was sold to downstream refiners. Currently, its main use is as diluent for Canadian heavy crude. Dilbit uses typically ~25% of condensate, where companies use their own supply sources of light hydrocarbons or

purchase CRW. Establishment of a CRW criteria document provides a guideline for new streams that are proposed to be blended with the CRW stream and ensures that the CRW pool characteristics remain acceptable for the use as diluent. Quality specifications include minimum and/or maximum levels, a referee test method and test frequency, as well as comments on enforcement measures to be taken [8].

Crude Quality Inc. (CQI) is a private company in Edmonton with a mandate “to produce, provide, and manage crude quality information that increases the productivity of our customers and the petroleum industry” [9]. CQI’s crude quality measurement and management system is supported by Canadian producer associations, Alberta/Canadian and US government departments, including the Energy Resources Conservation Board (ERCB), and Canadian and US technical organizations. CQI maintains a website with available data for most western Canadian crude oils, including conventional crudes as well as dilbit and other nonconventional grades and blends [10]. The site was established to enhance communication of data on the quality and quality issues of western Canadian crudes. Figure 1 summarizes some of the data in a series of graphs (see also Table 1). These are the properties of the crude oils entering the transmission pipeline system to be delivered to the refineries, after the addition of diluent in case of the dilbits. Enbridge has additional crude oil characteristics on their website [11]. Petroleum quality specifications of crude permitted in the pipeline system is further defined in National Energy Board (NEB) and Federal Energy Regulatory Commission (FERC) regulatory documents outlined in pipeline Tariffs (e.g. [12], [13], and [14]).

The above illustrates that conventional crude or dilbit is not transported indiscriminately without quality control measures and regulation. Work is ongoing continuously to improve overall quality control and product quality, primarily considering the effects on refining of the product.

The majority of pipelines are used for batches of different categories of crude. The pipeline operators are responsible for managing and controlling the quality of delivered crude and a number of measures are applied, including [15, 16]:

1. The use of turbulent flow, which minimizes the mixing area between batches. In laminar flow, the flow velocity near the pipe wall is much smaller than the velocity in the center of the pipe, which results in a relatively large mixing zone when one crude is followed by a different crude. The flow velocity is more even throughout the pipe cross-section in the case of turbulent flow, decreasing the subsequent mixing zone between different crudes.
2. The establishment of a crude ranking order, which serves as a guideline when changing crudes (e.g. a Medium Crude may be followed by a Medium Sour Crude, but not by a Heavy Crude).
3. The use of buffers at the front and the back of the batch to prevent mixing with the preceding batch or the following batch when the crude contains components that are undesirable by the refineries. In some instances, interface pigs can be used, but some contamination can occur at the pump and pig trap locations.
4. Maximization of batch size will minimize contamination from the mixing zones.
5. Minimization of start/stop operations.
6. Minimization of contamination in tanks from receipt to delivery

Although the operator will make an effort to deliver the same type of crude as received, the operator is not obligated to deliver the identical crude [12, 13, 14]. Changes in density, specification, quality and characteristics as a result of the transportation in the pipeline system are acknowledged. Unfortunately, crude quality information of the received oil product is not currently readily available. CQI is currently working with industry partners on the development of a downstream quality database for direct comparison with the upstream qualities with the goal to provide financial incentives for consistency and rateability [9]. The transparency offered by the information of crude oil quality databases on both the shipped and delivered product will be of tremendous assistance in communications between industry and the public.

Table 1 Crude Designation Used in Figure 1

Crude	Type of Crude and Designation Used in Figure 1
Bow River North	Heavy Sour A
Bow River South	Heavy Sour B
Lloyd Blend	Heavy Sour C
Fosterton	Heavy Sour D
Lloyd Kerrobert	Heavy Sour E
Midale	Medium Sour A
Mixed Sour Blend	Medium Sour B
Sour High Edmonton	Medium Sour C
Sour Light Edmonton	Light Sour A
Light Sour Blend	Light Sour B
Mixed Sweet Blend Crude	Light Sweet A
Access Western Blend	Dilbit A
Cold Lake	Dilbit B
Seal Heavy	Dilbit C
Albian Heavy Synthetic Crude	Dilsynbit A

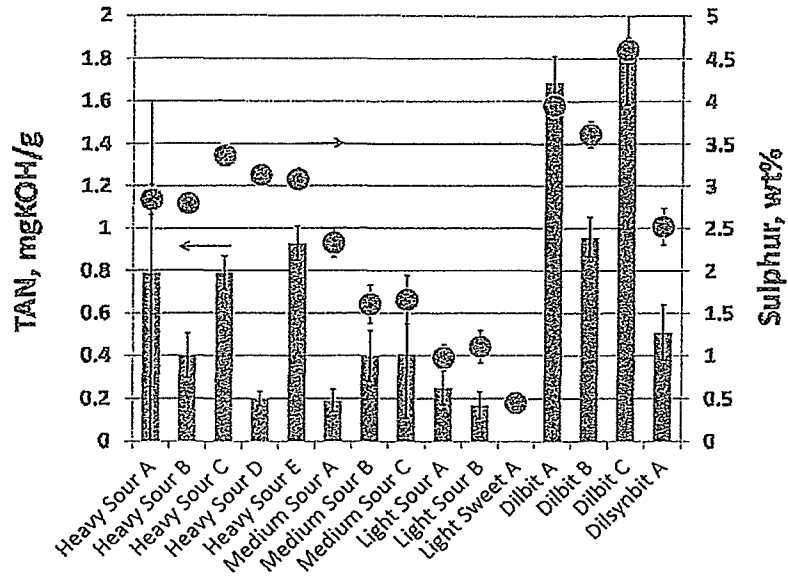

Figure 1a Properties of various conventional crudes and dilbits in Western Alberta illustrating acidity and sulphur contents. The data were obtained from Crude Quality Inc.'s website crudemonitor.ca [10]. Error bars represent the standard deviation over five years of data.

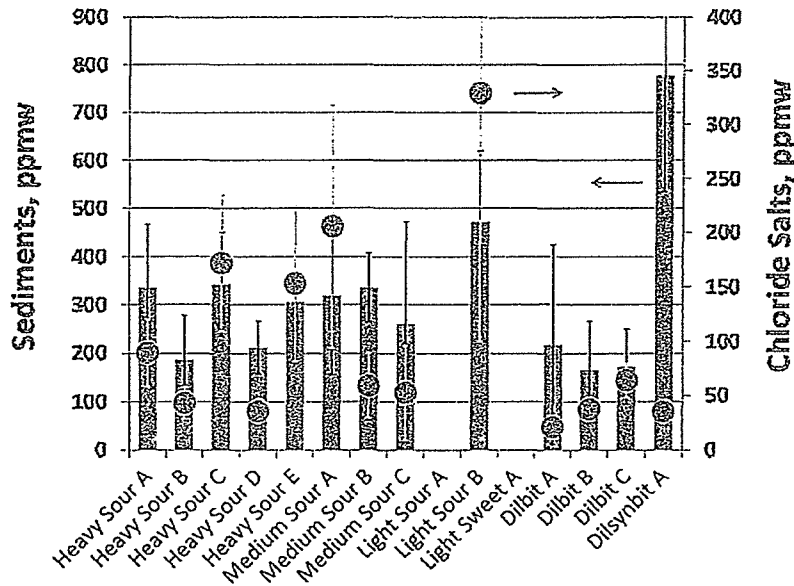

Figure 1b Properties of various conventional crudes and dilbits in Western Alberta illustrating the content of sediments and chloride salts. The data were obtained from Crude Quality Inc.'s website crudemonitor.ca [10]. Error bars represent the standard deviation over five years of data.

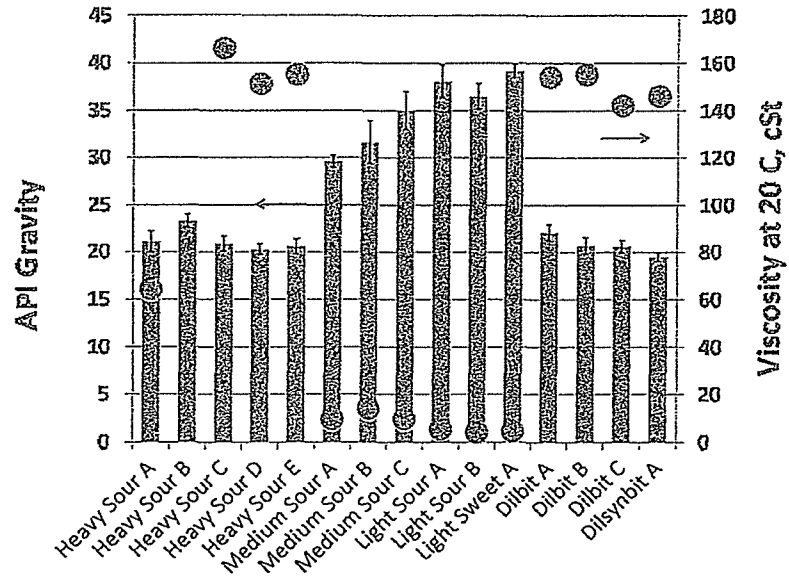

Figure 1c Properties of various conventional crudes and dilbits in Western Alberta illustrating the degree of API gravity and viscosity (after ref [11]). The API gravity data were obtained from Crude Quality Inc.'s website crudemonitor.ca [10]. Error bars represent the standard deviation over five years of data. One representative set of viscosity data is plotted.

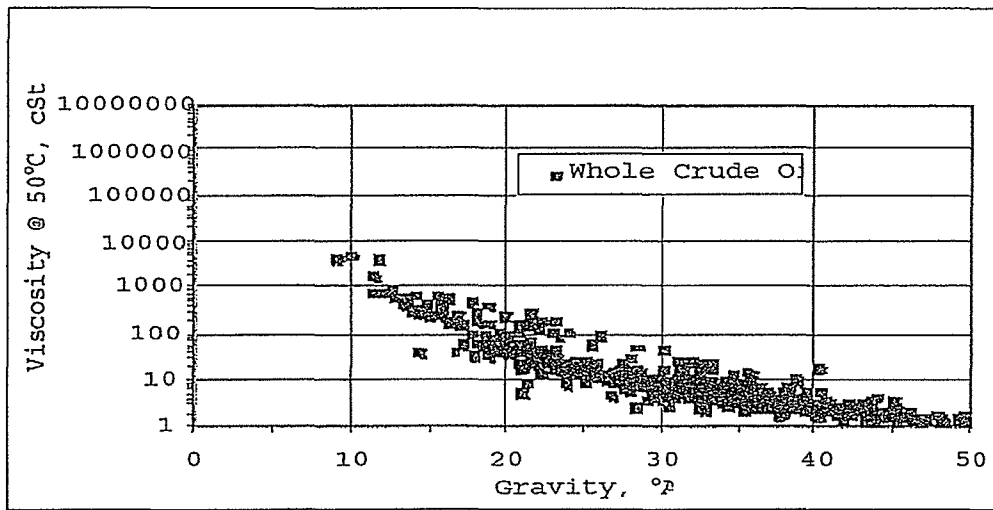

Figure 1d The gravity-viscosity relationship of conventional crude oils (after ref [17]).

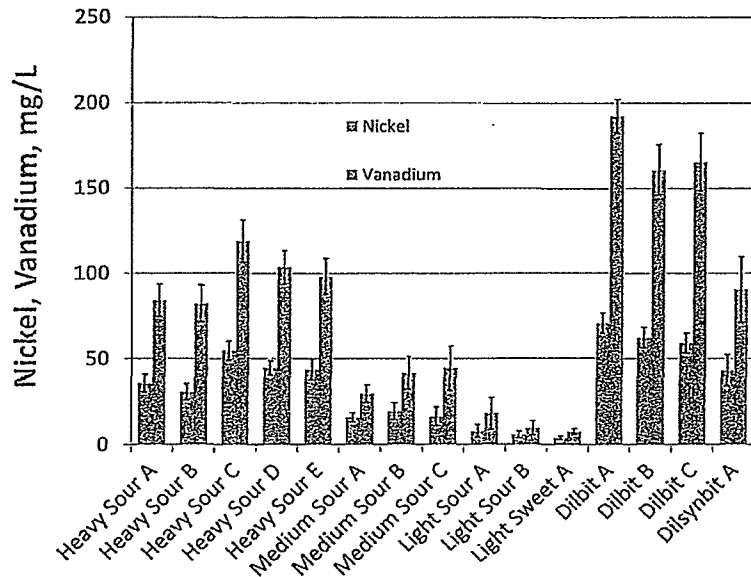

Figure 1e Properties of various conventional crudes and dilbits in Western Alberta illustrating heavy metal concentrations. The data for were obtained from Crude Quality Inc.'s website crudemonitor.ca [10]. Error bars represent the standard deviation over five years of data.

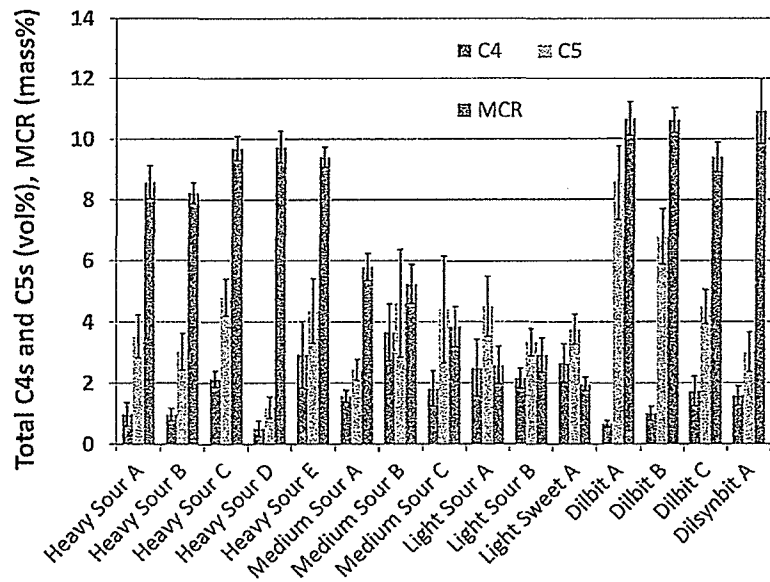

Figure 1f Properties of various conventional crudes and dilbits in Western Alberta illustrating fractions of light carbons and Micro Carbon Residue (MCR). The data were obtained from Crude Quality Inc.'s website crudemonitor.ca [10]. Error bars represent the standard deviation over five years of data.



## 5.0 DILBIT AND CONVENTIONAL CRUDE OIL PROPERTIES

With quality control measures in place, the properties of crudes entering the pipeline will be within defined boundaries. Yet, differences can be observed across the different crudes as well as within each crude category. Figure 1 displays data obtained from the Crude Monitor [10], where the plotted data are averages over periods of approximately five years. Error bars indicate the standard deviation. Data is presented for five different conventional heavy sour crudes, three conventional medium sour crudes, two conventional light sour crudes, one conventional light sweet crude, three dilbit crudes and one dilsynbit crude. Whereas dilbit can also refer to heavy conventional crudes that have been diluted with diluent or diluted crudes obtained by other means e.g. enhanced oil recovery, the dilbits in Figure 1 refer to oil sands crudes, where dilbit A is obtained from steam assisted gravity drainage (SAGD) processes and dilbits B and C from cyclic steam stimulation (CSS). Oil sands crude obtained from mining operations were either upgraded or blended with other crudes. For this reason, dilsynbit A has been added, which originates from mining operations, but is partially upgraded.

### 5.1 Naphthenic acids

**Claim #1: Dilbit contains fifteen to twenty times higher corrosive acid concentrations than conventional crude oil [1].**

Under refinery conditions and temperatures, naphthenic acids compounds can be corrosive. Naphthenic acids are a group of organic acids measured in terms of a total acid number (TAN), which is obtained by titration of the oil with KOH. TAN numbers have, therefore the units of mg KOH/g. Crude oils with TAN values greater than 0.5 are generally considered corrosive. However, recent work has indicated that not all naphthenic acids are equally corrosive and the acid groups attached to large hydrocarbon molecules found in heavy crudes and dilbits are more stable and less corrosive [19, 20, 21, 22]. Consequently, the TAN number is not necessarily reflective of the corrosivity of crude at elevated temperatures.

Figure 1a indicates a higher TAN for dilbits A and C, whereas dilbit B and dilsynbit A are comparable to the conventional heavy sour crudes. Research is continuing into the effects of these parameters at refineries, where upgrading of materials and the use of inhibitors can be used to mitigate any increase in corrosivity [19]. However, the acids are too stable to be corrosive under transmission pipeline temperatures. On the contrary, long chain organic acids have been found to decrease the corrosion rate at room temperature [23]. Furthermore, a number of Californian crudes have TAN numbers up to 3.2, and these crudes have been produced and transported by pipeline throughout California for many years [24].

### 5.2 Sulphur content

**Claim #2: Dilbit contains five to ten times as much sulfur as conventional crudes; the additional sulfur can lead to the weakening or embrittlement of pipelines [1].**

Under refinery conditions and temperatures, organic sulphur compounds can be corrosive. A wide variety of sulphur compounds are present in crude oil, which, when heated, will be released as corrosive hydrogen sulphide. The release of hydrogen sulphide again depends on

the stability of the organic sulphur compound, and high temperatures between 220 and 400 C are required. With a wide variety of sulphur compounds and stabilities, the sulphur content of crude is also not a good measure of the corrosivity of crude at refinery conditions [22].

Similar to the TAN numbers, Figure 1a indicates a higher sulphur concentration for dilbits A and C, whereas dilbit B and dilsynbit A are comparable to the conventional heavy sour crudes. Under transmission pipeline temperatures, organic sulphur compounds are too stable to be corrosive. At room temperature, sulphur containing compounds were found to have no effect or resulted in a decrease in the corrosion rate [23].

The sulphur content does not correlate to the hydrogen sulfide content, which is not typically reported. As an example, two Mexican crudes with sulfur contents of 3.4% and 0.9% contained 100 ppm and 116 ppm of H<sub>2</sub>S, respectively [4]. Small concentrations of H<sub>2</sub>S may be present in sour as well as sweet crudes. Concentrations could vary from a few ppm to over a hundred ppm. The CRW diluent is limited to 20 ppm of H<sub>2</sub>S [8]. Although the H<sub>2</sub>S concentrations in dilbits are not available, there is no indication that these levels would be higher than in conventional crudes [4]. If available hydrogen sulfide could separate from the oil into an aqueous phase in the pipeline, the corrosivity of the water could increase. This would be valid for all oil systems and not specific to dilbit lines.

### 5.3 Chlorides

**Claim #3: Dilbit has a high concentration of chloride salts, which can lead to chloride stress corrosion cracking in high temperature pipelines [1].**

Figure 1b illustrates the levels of chloride salts for the crudes; light sour crude A and light sweet crude A did not have any data. The highest chloride salt concentration was observed for the conventional light sour B crude, with the dilbits displaying some of the lowest salt concentrations. Chloride salts can lead to the formation of strong hydrochloric acid in the presence of steam at upgrading and processing temperatures greater than 150 C, which can result in serious corrosion problems [26]. These conditions are not encountered in transmission pipelines. In fact, it has been shown that high salinity brines in contact with oils did not affect the corrosion rate [25]. Chloride stress corrosion cracking can be an issue in stainless steel equipment, but is not a mechanism encountered in carbon steel transmission pipelines [53].

### 5.4 Sediments

**Claim #4: Oil sands crude contains higher quantities of abrasive quartz sand particles than conventional crude, which can erode the pipelines [1].**

Figure 1b illustrates the levels of sediments for the crudes; light sour crude A and light sweet crude A did not have any data. The sediment content in Figure 1b is far below the limit of 0.5 volume percent (water + sediment) specified in the pipeline tariffs [12, 13, 14]. The sediment levels of the dilbit crudes were comparable to or lower than the conventional crudes, except for the dilsynbit crude with an oil sands mining origin, which showed more than double the quantity of solids than most other crudes. However, at ~800 ppmw (~0.027 volume percent), it is still well below the limit set by regulatory agencies and industry.

## 5.5 API gravity and viscosity

**Claim #5:** It has been suggested that dilbit could be up to seventy times more viscous than conventional crude oil. It has been claimed that the increase in viscosity creates higher temperatures as a result of friction [1].

The API gravity is a measure of how ‘heavy’ the crude is; heavy crudes have low degrees of API gravity (10-25) and light crudes have high degrees of API gravity (30-40). The formula for API gravity is defined by:

$$\text{API gravity (in degrees)} = (141.5/\text{SG}) - 131.5 \quad \text{Equation 1}$$

where SG = specific gravity at 15.6 C

Based on the density of water, any oil with an API value greater than 10 degrees at ~15.6 C is lighter than water. Figure 1c illustrates that the dilbit crudes have similar degrees of API and viscosities to the conventional heavy sour crudes. All of the crudes are well above the minimum of 19 degrees API gravity; only dilsynbit A has an average value below 20 at 19.5 degrees API gravity. Also, the viscosities are well below the limited receipt viscosity of 350 cSt specified by the crude petroleum tariffs [12, 13, 14]. The lower the viscosity, the easier the oil flows, where water has a viscosity of one cSt at 20 C. The viscosity is very sensitive to temperature and will increase at colder temperatures. To compensate for fluctuations in viscosity as a result of varying seasonal temperatures, the amount of diluent added to the crude will be adjusted to control the viscosity to the desired level. Figure 1d [17], shows how the API gravity is related to the viscosity at 50 C, representing gravities and viscosities of conventional heavy crudes. Based on the data from Figures 1c and 1d, the dilbit viscosities are not different from the conventional oil viscosities as a function of degrees API gravity.

Figure 1c shows that viscosities of the dilbit are comparable to those of conventional heavy crudes, but are significantly lower for the conventional medium and low sour crudes, which means that these crudes are easier to pump. Consequently, they require less pumping energy and/or the pumping capacity can be increased. The requirement for higher pumping energy to maintain a certain throughput of more viscous oil can translate into an increase in temperature at the pump station. Downstream of the pump station, the pipeline temperature decreases as a result of heat loss to the environment [18]. The maximum allowable temperature on the proposed Keystone line has been set at 70 C with a normal operating temperature of 49 C. Temperatures must be measured at the pump and at a downstream location to ensure compliance ([48], Appendix U). The dilbit crude quality and viscosity that are accepted for transportation support operating temperatures within an acceptable range.

## 5.6 Other properties for consideration

The following properties are important for downstream processing of the crude and further illustrate where differences can be expected between dilbit and conventional crude. These properties have not been linked to pipeline transmission corrosion.

### 5.6.1 Heavy metals: nickel and vanadium

Crude oil analyses often include the nickel and vanadium content, since these metals have detrimental effects on catalysts used in refinery cracking and desulphurization processes. Figure 1e shows that the vanadium levels are markedly higher for the dilbit crudes as compared to the conventional crudes. The nickel levels are more comparable with the conventional heavy sour crude levels. These metals have not been linked to corrosive processes in oil transmission pipelines [25].

### 5.6.2 Total C4s and C5s

The C4s and C5s in Figure 1f represent the lighter fractions of the crude. The higher fractions of C5s in Dilbits A and B are likely largely originating from the added diluent.

### 5.6.3 Total MCR

The Micro Carbon Residue (MCR) content in Figure 1f is a measure of the crude oil tendency to form coke, where crudes with a high MCR are more expensive to refine. The MCR content increases with the content of large high carbon molecules and can, therefore, be considered a measure of the heavy fraction of the crude [17, 27]. The MCR content of the dilbits are only slightly higher than that of the conventional heavy sour crudes. The asphaltenes content was not reported in the Crude Monitor database [10].

The above illustrates that the dilbit properties as displayed in Figure 1 are not significantly different from the conventional heavy crude oils for pipeline transportation. However, internal pipeline corrosion has occurred in some dilbit lines whereas others have enjoyed a long trouble free existence [28]. Our understanding of some of the parameters and their interactions are discussed in the following sections.

## 6.0 INTERNAL PIPELINE CORROSION IN WATER-WET CONDITIONS

Steel wet by oil does not corrode. Consequently, for corrosion to occur, separation of a water phase from the oil is required. Unlike transmission pipelines, gathering oil pipelines can contain significant quantities of water when transporting oil from wells to nearby treatment facilities and internal corrosion is observed when the pipe is water-wet. The corrosion generally consists of localized pitting. The corrosivity of the water phase depends on the water chemistry, which is also dependent on the oil chemistry. Water soluble inhibitive or corrosive components may separate from the oil into the water phase, either inhibiting corrosion or increasing the water corrosivity [23, 25]. Work by Papavinasam et al. has considered pipeline characteristics, and operating conditions in the development of an internal pitting corrosion model using laboratory and field measurements [29, 30]. The model addresses water-wet conditions with no corrosion occurring in oil-wet conditions. Parameters that increased the pitting corrosion rate included flow turbulence, temperature, and chlorides. The pitting corrosion was decreased by protective scale formation (sulfide or carbonate scales) [31]. The model was validated using data obtained from seven operating pipelines [29]. A comprehensive review of other predictive models of internal pipeline corrosion is provided from a corrosion science perspective [32], electrochemical perspective [33], and using a corrosion engineering approach [34].

## 7.0 INTERNAL CORROSION OF DILBIT TRANSMISSION PIPELINES

**Claim #6:** The Alberta pipeline system has had approximately sixteen times as many spills due to internal corrosion than the U.S. system, indicating that the dilbit is much more corrosive than the conventional oil that is primarily flowing through U.S. lines [1].

The ERCB responded to the above statement that the comparison is not valid since the ERCB statistics includes a much broader array of pipelines [2]. For example, the US Code of Federal Regulations does not include all gathering lines in their hazardous liquids classification [35], whereas a large percentage of all Alberta lines are upstream gathering lines. Gathering lines are generally more prone to failure since they contain more water and can contain corrosive carbon dioxide and hydrogen sulfide gases. Furthermore, the ERCB requires operators to report any pipeline incident that results in a loss of pipeline product, whereas the US data is based on incidents with a release of 5 gallons or more. In response to the above concern, PHMSA and the ERCB adjusted the statistics to comparable crude oil systems, where the oil sands derived crude oil consisted of a much larger percentage in Alberta than in the entire U.S. [4]. The criteria used to produce the Alberta statistics are quite open and based on pipe diameter, where, as a rule, larger diameter pipelines (12" dia. and up) transport oil over longer distances and are oil-wet [54]. Table 2 is reproduced from the FEIS, page 3.13-38 [4]. The data shows that the internal corrosion rates in Alberta and in the U.S. are comparable, which indicates that there is no evidence that dilbit would be more corrosive than conventional crudes.

The publicly available ERCB data do not separate the statistics for dilbit and conventional crude pipelines or for upstream gathering lines and long distance transmission pipelines. Whereas the ERCB licenses pipelines for the use of crude oil, they may not be aware of what type of crude is shipped through the lines, which is further complicated by the fact that lines can transport dilbit and conventional crude at different points in time. It is recommended that better statistics be provided as an improved presentation of the integrity of the Alberta pipeline system and to facilitate continuous monitoring of the performance of dilbit pipelines. The required information for these statistics may need to come from the operators and could be managed by the ERCB or other company organizations such as CAPP or the Canadian Energy Pipeline Association (CEPA). CEPA represents Canada's transmission pipeline companies; its members transport 97% of Canada's daily production of crude oil and natural gas.

The remainder of this chapter considers how a corrosive situation can occur in crude oil pipelines and considers the role of dilbit and conventional crude oil properties.

Table 2 Crude Oil Pipeline Failures U.S. and Alberta (2002-2010) [4]

Incident/Failure Case	Failures/Year	Failures per 1,000 Pipeline Miles per Year
<b>U.S. Crude Oil Pipeline Incident History<sup>a</sup></b>		
Corrosion - External	9.8	0.19
Corrosion - Internal	22.1	0.42
All Failures	89.3	1.70
<b>Alberta Crude Oil Pipeline Incident History<sup>b</sup></b>		
Corrosion - External	2.3	0.21
Corrosion - Internal	3.6	0.32
All Failures	22.0	1.97

<sup>a</sup>PHMSA includes spill incidents greater than 5 gallons. U.S. has 52,475 miles of crude oil pipelines in 2008.

<sup>b</sup>Alberta Energy and Utility Board Report. Alberta has 11,187 miles of crude oil pipelines in 2006.

## 7.1 Presence of Water

The internal corrosion models referred to in the previous chapter have been developed for a wide range of operating pipelines varying from upstream to transmission, for both oil and gas lines, as well as multi-phase pipelines with high cuts of water. The current review is aimed primarily at transmission pipelines, which will have a limitation on the basic sediment and water (BS&W) content entering the pipe of 0.5 volume percent [12,13,14]. The presence of a small quantity of water is inevitable, since complete removal of emulsified water is not possible with the current techniques such as desalting and naphtha-froth treatment. A survey performed in 1997 of Western Canadian oil producers indicated an average BS&W of 0.35%, with solids up to 60% of the BS&W [36]. At that time, some American pipeline companies shipped crude containing as much as 3% water, but did not experience a great increase in the corrosion rate. A typical BS&W of the CRW diluent is as low as 0.003 vol% [8]. The critical water content that will lead to water-wet conditions during transportation can vary widely depending on chemistry and operating conditions, but is generally much greater than 10 percent [30]. Consequently, less than 0.5% of water is usually not a corrosion concern unless conditions exist that enable the precipitation and accumulation of this water on the pipe wall. The following paragraphs discuss some of the crude oil components that could promote the accumulation of water and the formation of a corrosive environment. The discussion does not consider entry of water through batch upsets or water remaining in the system after hydrostatic testing. These are operational issues and not unique to the transported crude.

## 7.2 Asphaltenes

Asphaltenes are found in heavy crude oil and consist of positively charged complex large multi-ring hydrocarbon systems. They are in effect a solubility class, i.e. a fraction of the crude oil that is not soluble in paraffinic solvents, which are chained non-polar hydrocarbons [37, 38]. They are known to aggregate in solutions in a micro-emulsion, where an asphaltene core is surrounded by resins (with fewer hydro-carbon rings), which are surrounded by

smaller hydro-carbon ring molecules, which in turn are dissolved in the non-polar solvent. This micro-emulsion structure allows the asphaltenes to dissolve in the crude oil [39]. When this micro-emulsion structure is disrupted through, for example, the addition of a paraffinic solvent that removes the protective resin layer, the asphaltenes will become insoluble and precipitate out.

Depending on the characteristics of the diluent, its addition to bitumen could result in the formation of unstable asphaltene micro-emulsions that could deposit during pipeline transportation [37, 40]. The asphaltene content of typical oil sand bitumens is 15-17 wt% and is partly responsible for the high viscosity. Complete removal of the asphaltenes does not reduce the viscosity to the required 350 cSt, but partial removal of the asphaltenes reduces the diluent requirement significantly. The additional benefit is that asphaltene precipitation is much less likely to occur [37].

The quality specifications of the CRW pool are primarily directed towards the downstream properties of the crude for refinery purposes, which affects the economic value of the crude. The Crude Monitor database contains 5-year averages of the CRW hydrocarbon composition, which indicates that ~80% consists of paraffinic solvents of eight carbons or less [10]. The remaining 20%, however, may contain the required properties to provide suitable compatibility with the mixed heavy crude oil. The Canadian Crude Quality Technical Association (CCQTA) is considering the compatibility of blending crude oils and diluent [52] in an effort to ensure that the product can be processed and refined. Calculator tools are provided on the Crude Monitor website [10]. Whereas asphaltene deposition can occur in response to incompatible blends in pipelines, the role of asphaltenes in pipeline sludge formation is unclear.

### 7.3 Emulsified water droplets

The solubility of water in oil is very small and of the order of 50 – 100 ppm [41]. The remainder of the water is primarily present as an emulsion, where the pipeline surface remains protected from corrosion by the continuous oil phase. These water droplets are very small and typically less than 10 microns in diameter [42, 43]. They carry chlorides and solids and can result in corrosion when the emulsion breaks up on the pipe wall, wetting the carbon steel surface. The stability of water-in-oil emulsions is a function of the oil chemistry, the water chemistry, and operating conditions.

One of the major players in stabilizing water in oil emulsions is asphaltene, forming an interfacial layer together with smaller surface active molecules and submicron mineral solids that is several tens of nanometers thick [44]. Ultrafine submicron clay particles are thought to be just as important in the stabilization of the water droplets, behaving similar to the asphaltenes [45, 46]. The formed skin is strong enough to resist coalescence of the droplets when they touch each other. These small micro-emulsions are too light to settle out in turbulent flow of crude oil and are expected to travel harmlessly through the pipeline. However, if bitumen is mixed with paraffinic solvents resulting in the precipitation of asphaltenes, these polar asphaltene flocs could bind to water droplets and clay particles forming much larger 100 to 1000 micron clusters that could settle out during transportation [43].

#### 7.4 Pipeline sediment and sludge formation

**Claim #7:** An increased risk of internal corrosion may be related to the sediment composition of dilbits and specific sediment characteristics, including particle hardness and size distribution [4].

Figure 1b did not indicate a much higher content of sediments for the dilbit crudes compared to the conventional crudes, except for dilsynbit A. The data, however, only indicates the total amount of sediments and does not provide information on the size distribution. It is unknown how the solids in the conventional crudes compare to those in dilbits.

Analyses of pipeline deposits obtained from pigging operations have indicated the presence of larger solids to over 400 microns [47]. Most of the solids, however, were fine particles less than 44 microns in diameter (see Figure 2a), where the larger and fine particles consist primarily of silica sand and iron compounds. The larger sand particles were uniformly coated with very fine clays surrounded by a film of water in oil (see Figure 2b) [47]. Under low flow conditions, these particles are heavy enough to precipitate out with the water, oil products, and possibly asphaltenes, forming a sludge deposit. Sludge deposits are mixtures of hydrocarbons, sand, clays, corrosion by-products, biomass, salts, and water.

One might expect deposition of sludge to occur at the lowest spots. However, Enbridge observed underdeposit corrosion in their dilbit lines near over-bends, which are locations of low fluid shear stress (low fluid flow pressure) [47]. Little is known about the sludge deposition mechanism and it is not known if sludge formation would occur in the presence of only fines.

#### 7.5 Underdeposit corrosion

The water layer on deposited sand particles in a pipeline sludge can subsequently join to form a water layer on the pipeline steel [47]. The water will contain chloride salts as well as bacteria, which now form a corrosive mix. The sludge chemistry can vary widely, where some sludges have a large percentage of waxy oil and exhibit low or no corrosion. Other sludges can contain more than 10% water and large bacterial populations, which can contribute to underdeposit pitting corrosion [48]. Figure 3 shows extensive pitting of a sludge covered test coupon, whereas a bare coupon showed no corrosion after both were exposed to dilbit for a month. No significant corrosion has been measured in a wide variety of different dilbit crudes in the absence of sludge, where the measured corrosion rate generally was within the standard deviation of the measurement technique.



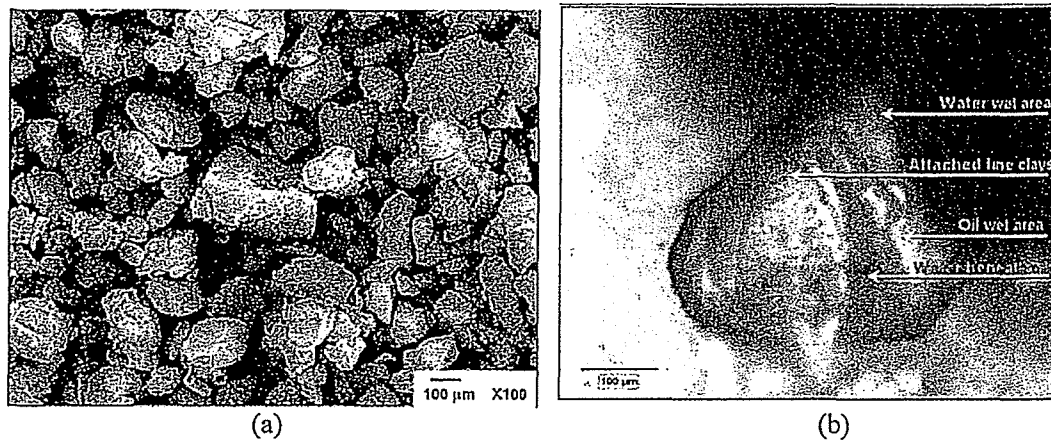

Figure 2 Micrograph of (a) washed sludge solids and (b) a large solid (from [47])

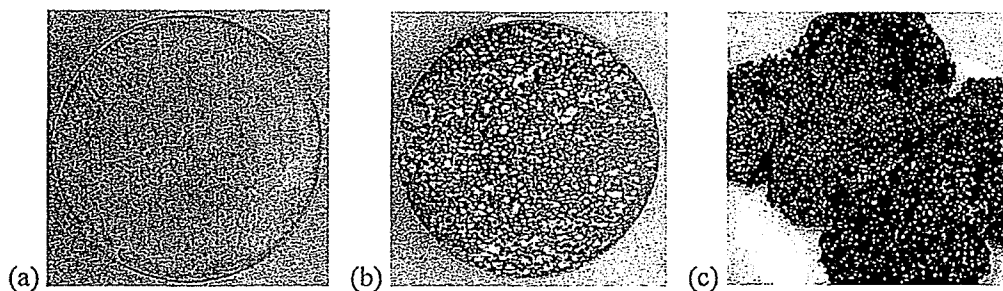

Figure 3 Corrosion coupons exposed to dilbit for 4 weeks, where (a) was left bare and (b) was covered with (c) sludge

The pipeline sludges used for analysis and testing are obtained from pigging runs and are considered averages over the length of the pipe and the time between pigging runs. The actual sludge chemistry may vary within a stratified sludge deposit or between different locations or with time as a function of transported crude. Questions remain regarding the controlling corrosion parameters and little is known with regard to the sludge deposition mechanism and the role of the dilbit chemistry. Whereas underdeposit corrosion has been observed on transmission pipelines transporting dilbit, there are also dilbit pipelines that have operated trouble-free for 25 years [28].

Underdeposit corrosion, however, is not unique to dilbit lines. Earlier this year, BP shut down their Trans-Alaska pipeline, which transports oil from their Prudhoe field. Previous leaks in 2006 resulted in the shutdown of 57 oil wells in Alaska [49]. Corrosion was attributed to the deposition of sludge, the presence of carbon dioxide, and, what was considered to be the biggest threat, the presence of bacterial populations resulting in microbiologically influenced corrosion (MIC) [50]. It is not known what the solid content or solid size distribution was in this line, but the conditions obviously favoured sludge deposition.

## 7.6 Erosion and Erosion Corrosion

**Claim #8:** A combination of chemical corrosion and physical abrasion can dramatically increase the rate of pipeline deterioration [1].

Erosion by sediment particles would occur by impact. Since corrosion can only occur in the presence of a water phase, which most likely requires sludge formation in dilbit pipelines, a combination of erosion and corrosion is improbable. No information could be found on dilbit pipeline erosion in the scientific literature or from field experience. Erosion in a uniform smooth pipeline generally displays itself as even wear as opposed to the localized pitting corrosion observed underneath sludge deposits. If present, effects are generally more gradual and should not be a concern due to the fact that regular mitigation strategies such as intelligent pigging and monitoring technologies will catch this wall loss.

## 8.0 TEMPERATURE EFFECTS

### 8.1 The effect of temperature on the internal corrosion rate

**Claim #9:** As a result of the high viscosity of dilbit, pipelines operate at temperatures up to 158 F, whereas conventional crude pipelines generally run at ambient temperatures. The high temperature would significantly increase the corrosion rate which doubles with every 20 degree Fahrenheit increase in temperature [1].

An increase in the temperature can increase the rate of corrosion if the corrosion mechanism is controlled by kinetics or diffusion. There are, however, many other factors that affect the rate of corrosion such as scale formation, limiting concentration of reactants, or chemical reactions. Especially in a complex aqueous environment, possibly with dissolved organics, acid gases, oxygen, sub-micron clay particles, etc., the corrosion rate can either increase or decrease as a function of temperature. The concentration of oxygen or carbon dioxide is generally not known and, if present, may change along the length of the pipeline. The most likely internal corrosion mechanism in dilbit pipelines consists of underdeposit corrosion as a result of sludge formation. As discussed in the preceding section, microbiologically induced corrosion could play a dominant role in the corrosion process. Complex populations containing multiple types of bacteria are known to be present and support each other's viability such as sulfate reducing bacteria (SRB), heterotrophic aerobic bacteria (HAB), and acid producing bacteria (APB) [48]. These bacteria are most active between 10 C and 40 C. Consequently, higher temperatures up to 70 C may reduce the corrosion rate underneath sludge deposits, if the mechanism is controlled by microbial action.

Little is known about the controlling factors of corrosion underneath sludge deposits and it is recommended that research continue to improve our understanding of sludge formation, the resulting corrosion mechanism, the role of dilbit chemistry and solids, mitigation practices and frequencies, and preventive measures. Enbridge has been quite successful in mitigating underdeposit corrosion through a pigging and inhibition program. However, there are still many uncertainties regarding the effectiveness of each and the required frequency [47].

## 8.2 The effect of temperature on external stress corrosion cracking

**Claim #10: Dilbit pipelines may be subject to a higher incidence of external stress corrosion cracking [4].**

In the field, the pipeline is protected by coatings and cathodic protection. Increased temperatures may result in coating disbondment, which would expose the bare pipe to the soil environment, which can be corrosive containing water, dissolved oxygen and carbon dioxide. Together with fluctuating pipeline operating stresses, this has resulted in stress corrosion cracking (or fatigue cracking) of pipelines covered with tape or asphalt coatings. These coatings can behave as shielding coatings, preventing the secondary protection of applied cathodic current. The Keystone pipeline is coated with Fusion Bonded Epoxy (FBE), which is considered permeable to the cathodic protection current. Temperatures up to 60 C have indicated a higher rate and extent of coating disbondment, but it has also been shown that, in the presence of cathodic protection, the pipe will remain protected, and blistering and coating disbondment does not present an integrity threat to a pipeline [51]. No stress corrosion cracking failures have been reported for FBE coatings in over 40 years of experience.

## 9.0 SUMMARY

Pipeline expansions for the transportation of Canadian crude to refining markets in the United States are currently under regulatory review. The transported oil originates primarily from the Alberta oil sands and consists of diluted bitumen, also referred to as dilbit. Alberta Innovates – Technology Futures completed a project for Alberta Innovates – Energy and Environment Solutions reviewing the current status on the corrosivity of dilbit in pipelines as compared to conventional or ‘non-oil sands derived’ crude oil.

It has been suggested that dilbit has higher acid, sulfur, and chloride salts concentrations, as well as higher concentrations of more abrasive solids. It is furthermore suggested that dilbit transmission pipelines operate at higher operating temperatures compared with conventional crude, which would make the dilbit more corrosive, thus leading to a higher failure rate than observed for pipelines transporting conventional crude. This review examines these concerns in light of the properties of dilbit in comparison with conventional oils. In addition, statistical data are presented to show if the concerns are supported by operating experience.

Conventional crude and dilbit are subject to quality control measures and regulation. Pipeline operators employ further measures during transportation to manage and control the quality of delivered crude. Alberta crude quality information is available online and accessible to the public. The properties of heavy, medium, and light conventional Alberta crude oils were compared with three dilbit and one dilsynbit crude.

Whereas two of the four dilbit crudes displayed a slightly higher naphthenic acid and sulfur concentration than the conventional Alberta heavy crudes, there are conventional crudes on the market that have displayed higher values yet. The chloride salt concentrations were either comparable or lower than all grades of conventional crude. Naphthenic acid, sulfur, and chloride salt concentrations can result in corrosion at temperatures greater than 200 C at refineries, where mitigation is addressed through upgrading of materials and the use of

inhibitors. At the much lower pipeline transportation temperatures, the compounds are too stable to be corrosive and some may even decrease the corrosion rate.

The sediment levels of the dilbit crudes were comparable to or lower than the conventional crudes, except for a dilsynbit crude, which showed more than double the quantity of solids than most other crudes, but was still well below the limit set by regulatory agencies and industry. The solids size distribution is unknown as is the role of larger size solids in the formation of pipeline deposits. Erosion corrosion was found to be improbable and erosion, if present, is expected to be gradual and observed by regular mitigation practices.

The dilbit viscosities are comparable to those of heavy conventional crudes, where the viscosity is controlled and adjusted for temperature through the addition of diluent. The resulting dilbit viscosity supports acceptable operating temperatures, which will be monitored at and downstream of the pumping stations.

Adjustment of the Alberta and U.S. pipeline failure statistics to compare similar crude oil pipeline systems on an equivalent basis indicated that the Alberta systems (with a large percentage of dilbit lines) experienced comparable internal corrosion failure rates than the U.S. systems (predominantly conventional crude lines).

Pipeline steel wet by oil does not corrode. The basic sediment and water (BS&W) content of crude oil transmission pipelines is limited to 0.5 volume percent. This water is primarily present as a stable emulsion, maintaining an oil wet pipe, protected from corrosion. Pitting corrosion has been observed underneath sludge deposits. These deposits are a mix of sand and clay particles, water, and oil products. The corrosivity of these sludges varies but seems to be linked to water content, which can exceed 10%, and large bacterial populations. The sludge deposition mechanism and the contributions of each of its components to its corrosivity are not clear. Sludge deposition and similar underdeposit corrosion is not unique to dilbit lines and also has been observed in pipelines transporting conventional crudes.

This review has indicated that the characteristics of dilbit are not unique and are comparable to conventional crude oils.

## 10.0 RECOMMENDATIONS

The following recommendations are provided based on the completed review. It has to be understood that this was a high-level review and a focused, peer-reviewed study has not been conducted. The scope of the work did not include interviews with industry, regulators, or colleagues.

1. CQI is currently working with industry partners on the development of a downstream quality database for direct comparison with the upstream qualities with the goal to provide financial incentives for consistency and rateability. The data provided on upstream qualities has been instrumental in the evaluation of differences between dilbit oils and conventional crude oils. The transparency offered by the information of crude oil quality databases on both the shipped and delivered product will be of tremendous assistance in communications between industry and the public. It will

also be a valuable resource for the evaluation of sludge deposition and underdeposit corrosion during transportation. It is recommended that this effort be supported.

2. To further increase the value of the above database, it is recommended that the following information be added:
  - a. H<sub>2</sub>S concentration
  - b. Asphaltene content
  - c. Water content
  - d. Viscosity (currently available from [11])
  - e. Sediments' identity and size distribution, if possible
3. The compatibility between diluent and bitumen should be investigated further with regard to sludge formation and deposition, and the role of asphaltenes. It is recommended that current efforts by CCQTA on crude oil compatibility be supported and expanded to link the crude oil chemistry to pipeline sludge formation and sludge corrosivity, including the ability of the sludge to support microbial populations.
4. The underdeposit corrosion mechanism should be studied further with regard to the effect of dilbit chemistry, sludge deposition mechanism, microbial activity, temperature, and effectiveness of mitigation tools (chemicals and cleaning pigs). Current work by Enbridge as well as by the industry working group PiCoM (Pipeline Corrosion Management) is addressing these issues through long-term testing and correlating sludge corrosivity with a chemical and microbial geochemical characterization of the sludge. The work is further considering and optimizing monitoring technologies to enable measurement of the effectiveness of mitigation treatments. It is recommended that this effort will continue to be supported.
5. The publicly available ERCB data does not separate the statistics for dilbit and conventional crude pipelines or for upstream gathering lines and transmission pipelines. It is recommended that better statistics be provided as an improved presentation of the integrity of the Alberta pipeline system and to facilitate continuous monitoring of the performance of dilbit pipelines. The required information for these statistics may need to come from the operators and could be managed by the ERCB or other company organizations such as CAPP or the Canadian Energy Pipeline Association (CEPA).

## 11.0 REFERENCES

1. Swift, Anthony, S. Casey-Lefkowitz, E. Shope, Tar Sands Pipelines Safety Risks, Natural Resources Defense Council, [www.stopdirtyfuels.org](http://www.stopdirtyfuels.org), Feb, (2011).
2. ERCB News Release, "ERCB addresses statements in Natural Resources Defense Council Pipeline Safety Report," [www.ercb.ca](http://www.ercb.ca), Calgary, Alberta, February 16 (2011).
3. Rascoe, A., "Oil sands' impact on pipes needs study-US lawmakers," The National Post, June 16 (2011).
4. US Department of State, Final Environmental Impact Statement for the Keystone XL Project, <http://www.keystonepipeline-xl.state.gov/>, August 26 (2011).

5. Schor, E., "With Emotions High and Evidence Low, Corrosion Questions Hound Canada-To-U.S. Oil Pipeline," *The New York Times*, August 23 (2011).
6. Vanderklippe, N., "Oil sands critics target a new concern – pipelines," *The Globe and Mail*, Aug 1 (2011).
7. Segato, R., "Quality Guidelines for Western Canadian Condensate," presentation at the Crude Oil Quality Association, June (2008).
8. Segato, R., "Enbridge Condensate Pool (CRW) Specifications," presentation at the Crude Oil Quality Association, Feb (2010).
9. Crude Quality Inc., <http://crudequality.com/index.html> (last accessed Sept 25, 2011)
10. Crude Monitor, <http://www.crudemonitor.ca/> (last accessed Sept 25, 2011). *Please note that all data and information, or any analyses prepared from the data and information provided on this website, may not be reproduced for publication, presentation, redistribution or resale in any fashion. The contents of the crudemonitor.ca pages may be freely copied, but only for personal or internal company use.*
11. Enbridge 2010 Crude Characteristics, No 41, <http://www.enbridge.com/DeliveringEnergy/Shippers/CrudeOilCharacteristics.aspx>, (last accessed Sept 25, 2011).
12. NEB No 282, Crude Petroleum Tariff for Enbridge Pipelines Inc., Rules and Regulations governing the Transportation of Crude Petroleum, March (2008).
13. NEB Tariff No. 4, "Keystone Pipeline System, Containing Rules and Regulations Applying to the Transportation of Petroleum," December (2010).
14. FERC No. 5.1.0, "TransCanada Keystone Pipeline, LP, Containing Rules and Regulations Applying to the Transportation of Petroleum," February 1 (2011).
15. Anand, A., "Enbridge System: Crude Types, Transportation and Quality Performance," Proceedings Crude Quality Association Meeting, San Antonio, Tx, Feb (2011).
16. Ha, A., "Keystone Pipeline: Charting New Territory," Minutes CCQTA Annual General Meeting, Calgary, AB, June (2011).
17. Boduszynski, M.M., C.E. Rechsteiner, A.S.G. Shafizadeh, and R.M.K. Carlson, "Composition and Properties of Heavy Crudes," 7<sup>th</sup> UNITAR International Conference on Heavy Crude and Tar Sands, Beijing, China, 1998, paper 1998.202 (1998).
18. Wu, C., C. Hongsheng, Z. Lili, "Some Interesting Flow Characteristics of a Heavy Crude Pipeline," Proceedings of the 6<sup>th</sup> International Pipeline Conference, Paper 10352 (2006).
19. Kane, R.D., E. Trillo, S. Srinivasan, "The state-of-the-art of naphthenic acid and sulfidic corrosion evaluation and prediction," AIChE Conference Proceedings (2006).
20. Messer, B., B. Tarleton, M. Beaton, T. Phillips, "New Theory for Naphthenic Acid Corrosivity of Athabasca Oilsands Crudes," CORROSION 2004, paper 04634 (2004).
21. Dettman, H.D., N. Li, J. Luo, "Refinery Corrosion, Organic Acid Structure, and Athabasca Bitumen," CORROSION 2009, paper 09336 (2009).
22. Dettman, H.D., N. Li, D. Wickramasinghe, J. Luo, "The Influence of Naphthenic Acid and Sulphur Compound Structure on Global Crude Corrosivity Under Vacuum Distillation Conditions," NACE Northern Area Western Conference, Feb (2010).
23. Ayello, F., W. Robbins, S. Richter, S. Nestic, "Crude Oil Chemistry Effects on Inhibition of Corrosion and Phase Wetting," CORROSION 2011, paper 11060 (2011).
24. Sheridan, M., "California Crude Oil Production and Imports," Fossil Fuels Office Fuels and Transportation Division California Energy Commission, Staff Paper, available at:

<http://www.energy.ca.gov/2006publications/CEC-600-2006-006/CEC-600-2006-006.PDF>, April (2006).

25. Stroe, M., N. Passade-Boupat, M. Bonis, B. Adams, "Inhibitive Properties of Crude Oils: Can We Count On Them?", CORROSION 2011, paper 11060 (2011).
26. Kaur, H., **Kinetics & Inhibition of Chloride Hydrolysis in Canadian Bitumens**, M.A.Sc. Thesis, University of Alberta, Spring (2009).
27. Schabron, J., J.G. Speight, "Correlation between Carbon Residue and Molecular Weight," Preprints Division of Fuel Chemistry, American Chemical Society, 42 (2), 386 (1997).
28. Personal communication.
29. Papavinasam, S., A. Doiron, R.W. Revie, "Model to Predicting Internal Pitting Corrosion of Oil and Gas Pipelines," Corrosion, Vol 66, No 3, p 035006-1 (2010).
30. Papavinasam, S., A. Doiron, R.W. Revie, V. Sizov, "Field Inputs Guide Internal Pitting Corrosion Model," Oil & Gas Journal, Vol 105, No 45, p 62 (2007).
31. Papavinasam, S., A. Doiron, R.W. Revie, "Effect of Surface Layers on the Initiation of Internal Pitting Corrosion in Oil and Gas Pipelines," Corrosion, Vol 65, No 10, p 663 (2009).
32. Papavinasam, S., R.W. Revie, A. Doiron, "Predicting Internal Pitting Corrosion of Oil and Gas Pipelines: Review of Corrosion Science Models," CORROSION 2005, NACE, Houston, paper 05643 (2005).
33. Papavinasam, S., R.W. Revie, A. Doiron, "Predicting Internal Pitting Corrosion of Oil and Gas Pipelines: Review of Electrochemical Models," CORROSION 2005, NACE, Houston, paper 05644 (2005).
34. Papavinasam, S., W. Friesen, R.W. Revie, A. Doiron, "Predicting Internal Pitting Corrosion of Oil and Gas Pipelines: A Corrosion Engineering Approach," CORROSION 2005, NACE, Houston, paper 05645 (2005).
35. Code of Federal Regulations, Title 49 Transportation, Part 195 Transportation of Hazardous Liquids by Pipeline, Sept 28 (2011).
36. Renouf, G, R. Ranganathan, R.J. Scoular, D. Soveran, "The Impact of Changing Canadian Pipeline BS&W Specifications: A Survey," Petroleum Society of CIM, Paper 97-179 (1997).
37. Rahimi, P., T. Gentzis, "The Chemistry of Bitumen and Heavy Oil Processing," Chapter 19 In: Practical Advances in Petroleum Processing Volume 2. Edited by Chang Samuel Hsu and Paul R. Robinson. New York: Springer Science, pages 149 – 185 (2005).
38. Masakatsu, N., P. Rahimi, O.R. Koseoglu, "Advances in Characterization and Utilization of Asphaltenes," **Heavy Hydrocarbon Resources**, Chapter 1, ACS Symposium Series, Vol 895 (2005).
39. Wiehe, I.A., K.S. Liang, "Asphaltenes, resins, and other macromolecules," Fluid Phase Equilibria, 117, pp 201-210 (1996).
40. Wiehe, I.A., H.W. Yarranton, K. Akbarzadeh, P.M. Rahimi, A. Teclemariam, "The Paradox of Asphaltene Precipitation with Normal Paraffins," Energy & Fuels, 19, pp 1261-1267 (2005).
41. Yaws, C., M. Rahate, "Table, correlation give water solubility, Henry's Law constant for alkanes in crude," Oil & Gas Journal, Vol 107, No 9, Mar (2009).
42. Wu, "Investigating the Stability Mechanism of Water-in-Diluted Bitumen Emulsions through Isolation and Characterization of the Stabilizing Materials at the Interface," Energy & Fuels, 17, pp 179-190 (2003).

43. Gray, M., Z. Xu, J. Masliyah, "Physics in the oil sands of Alberta," *Physics Today*, pp 31-35, March (2009).
44. Wu, X., J. Czarnecki, "Modeling Diluted Bitumen – Water Interfacial Compositions Using a Thermodynamic Approach," *Energy & Fuels*, Vol 19, p 1353 (2005).
45. Yan, N., M.R. Gray, J.H. Masliyah, "On water-in-oil emulsions stabilized by fine solids," *Colloids and Surfaces A: Physicochemical and Engineering Aspects* 193, pp 97-107 (2001).
46. Kotlyar, L.S., B.D. Sparks, J.R. Woods, "Solids Associated with the Asphaltene Fraction of Oil Sands Bitumen," *Energy & Fuels*, 13, pp 346-350 (1999).
47. Place, T.D., M.R. Holm, C. Cathrea, T. Ignacz, "Understanding and Mitigating Under-Deposit Corrosion in Large Diameter Crude Oil Pipelines – A Progress Report," *Proceedings of IPC2008*, paper 64562 (2008).
48. Been, J. et al., "Development of a Test Protocol for the Evaluation of Underdeposit Corrosion Inhibitors in Large Diameter Crude Oil Pipelines," *CORROSION* 2011, paper 11263 (2011).
49. Wearden, G., "BP Shuts Alaska Pipeline after Leak," *The Guardian*, Jan 10 (2011).
50. *The Chemical Engineer Today*, "Prudhoe Corrosion Blamed on Bacteria," September (2006).
51. Been, J., R. Given, K. Ikeda-Cameron, R.G. Worthingham, "Factors Affecting The Rate and Extent of Disbondment of FBE Coatings," *NACE CORROSION* 2005, paper 05138 (2005).
52. Rahimi, P., T. Alem, "Crude Oil Compatibility and Diluent Evaluation for Pipelining," *Proceedings of the Joint CCQTA/COQA Meeting*, New Orleans, Feb (2010).
53. McIntyre, D., "Experience Survey Stress Corrosion Cracking of Austenitic Stainless Steels in Water," *MTI Publication No 27* (1987).
54. Personal correspondence with the ERCB, Nov 1 (2011)



Transportation Research Board  
Special Report 311

# Effects of Diluted Bitumen on Crude Oil Transmission Pipelines

Prepublication Copy • Uncorrected Proofs

NATIONAL RESEARCH COUNCIL

EXHIBIT

2

tabbles

---

Transportation Research Board  
Special Report 311

---

# Effects of Diluted Bitumen on Crude Oil Transmission Pipelines

---

Committee for a Study of Pipeline Transportation of Diluted Bitumen

Transportation Research Board

Board on Energy and Environmental Systems

Board on Chemical Sciences and Technology

NATIONAL RESEARCH COUNCIL  
*OF THE NATIONAL ACADEMIES*

Transportation Research Board  
Washington, D.C.  
2013  
[www.TRB.org](http://www.TRB.org)

## **Transportation Research Board Special Report 311**

### **Subscriber Categories**

Energy; freight transportation; pipelines; policy; terminals and facilities

Transportation Research Board publications are available by ordering individual publications directly from the TRB Business Office, through the Internet at [www.TRB.org](http://www.TRB.org) or [national-academies.org/trb](http://national-academies.org/trb), or by annual subscription through organizational or individual affiliation with TRB. Affiliates and library subscribers are eligible for substantial discounts. For further information, contact the Transportation Research Board Business Office, 500 Fifth Street, NW, Washington, DC 20001 (telephone 202-334-3213; fax 202-334-2519; or e-mail [TRBsales@nas.edu](mailto:TRBsales@nas.edu)).

Copyright 2013 by the National Academy of Sciences. All rights reserved.  
Printed in the United States of America.

**NOTICE:** The project that is the subject of this report was approved by the Governing Board of the National Research Council, whose members are drawn from the councils of the National Academy of Sciences, the National Academy of Engineering, and the Institute of Medicine. The members of the committee responsible for the report were chosen for their special competencies and with regard for appropriate balance.

This report has been reviewed by a group other than the authors according to the procedures approved by a Report Review Committee consisting of members of the National Academy of Sciences, the National Academy of Engineering, and the Institute of Medicine.

This report was sponsored by the Pipeline and Hazardous Materials Safety Administration of the U.S. Department of Transportation.

### **Library of Congress Cataloging-in-Publication Data**

ISBN 978-0-309-28675-6

## THE NATIONAL ACADEMIES

*Advisers to the Nation on Science, Engineering, and Medicine*

The **National Academy of Sciences** is a private, nonprofit, self-perpetuating society of distinguished scholars engaged in scientific and engineering research, dedicated to the furtherance of science and technology and to their use for the general welfare. On the authority of the charter granted to it by the Congress in 1863, the Academy has a mandate that requires it to advise the federal government on scientific and technical matters. Dr. Ralph J. Cicerone is president of the National Academy of Sciences.

The **National Academy of Engineering** was established in 1964, under the charter of the National Academy of Sciences, as a parallel organization of outstanding engineers. It is autonomous in its administration and in the selection of its members, sharing with the National Academy of Sciences the responsibility for advising the federal government. The National Academy of Engineering also sponsors engineering programs aimed at meeting national needs, encourages education and research, and recognizes the superior achievements of engineers. Dr. Charles M. Vest is president of the National Academy of Engineering.

The **Institute of Medicine** was established in 1970 by the National Academy of Sciences to secure the services of eminent members of appropriate professions in the examination of policy matters pertaining to the health of the public. The Institute acts under the responsibility given to the National Academy of Sciences by its congressional charter to be an adviser to the federal government and, on its own initiative, to identify issues of medical care, research, and education. Dr. Harvey V. Fineberg is president of the Institute of Medicine.

The **National Research Council** was organized by the National Academy of Sciences in 1916 to associate the broad community of science and technology with the Academy's purposes of furthering knowledge and advising the federal government. Functioning in accordance with general policies determined by the Academy, the Council has become the principal operating agency of both the National Academy of Sciences and the National Academy of Engineering in providing services to the government, the public, and the scientific and engineering communities. The Council is administered jointly by both Academies and the Institute of Medicine. Dr. Ralph J. Cicerone and Dr. Charles M. Vest are chair and vice chair, respectively, of the National Research Council.

The **Transportation Research Board** is one of six major divisions of the National Research Council. The mission of the Transportation Research Board is to provide leadership in transportation innovation and progress through research and information exchange, conducted within a setting that is objective, interdisciplinary, and multimodal. The Board's varied activities annually engage about 7,000 engineers, scientists, and other transportation researchers and practitioners from the public and private sectors and academia, all of whom contribute their expertise in the public interest. The program is supported by state transportation departments, federal agencies including the component administrations of the U.S. Department of Transportation, and other organizations and individuals interested in the development of transportation. [www.TRB.org](http://www.TRB.org)

[www.national-academies.org](http://www.national-academies.org)

## **Transportation Research Board 2013 Executive Committee\***

**Chair: Deborah H. Butler**, Executive Vice President, Planning, and CIO, Norfolk Southern Corporation, Norfolk, Virginia

**Vice Chair: Kirk T. Steudle**, Director, Michigan Department of Transportation, Lansing

**Executive Director: Robert E. Skinner, Jr.**, Transportation Research Board

**Victoria A. Arroyo**, Executive Director, Georgetown Climate Center, and Visiting Professor, Georgetown University Law Center, Washington, D.C.

**Scott E. Bennett**, Director, Arkansas State Highway and Transportation Department, Little Rock

**William A. V. Clark**, Professor of Geography (emeritus) and Professor of Statistics (emeritus), Department of Geography, University of California, Los Angeles

**James M. Crites**, Executive Vice President of Operations, Dallas–Fort Worth International Airport, Texas

**Malcolm Dougherty**, Director, California Department of Transportation, Sacramento

**John S. Halikowski**, Director, Arizona Department of Transportation, Phoenix

**Michael W. Hancock**, Secretary, Kentucky Transportation Cabinet, Frankfort

**Susan Hanson**, Distinguished University Professor Emerita, School of Geography, Clark University, Worcester, Massachusetts

**Steve Heminger**, Executive Director, Metropolitan Transportation Commission, Oakland, California

**Chris T. Hendrickson**, Duquesne Light Professor of Engineering, Carnegie Mellon University, Pittsburgh, Pennsylvania

**Jeffrey D. Holt**, Managing Director, Bank of Montreal Capital Markets, and Chairman, Utah Transportation Commission, Huntsville, Utah

**Gary P. LaGrange**, President and CEO, Port of New Orleans, Louisiana

**Michael P. Lewis**, Director, Rhode Island Department of Transportation, Providence

**Joan McDonald**, Commissioner, New York State Department of Transportation, Albany

**Donald A. Osterberg**, Senior Vice President, Safety and Security, Schneider National, Inc., Green Bay, Wisconsin

**Steve Palmer**, Vice President of Transportation, Lowe's Companies, Inc., Mooresville, North Carolina

**Sandra Rosenbloom**, Director, Innovation in Infrastructure, The Urban Institute, Washington, D.C. (Past Chair, 2012)

**Henry G. (Gerry) Schwartz, Jr.**, Chairman (retired), Jacobs/Sverdrup Civil, Inc., St. Louis, Missouri

**Kumares C. Sinha**, Olson Distinguished Professor of Civil Engineering, Purdue University, West Lafayette, Indiana

**Daniel Sperling**, Professor of Civil Engineering and Environmental Science and Policy; Director, Institute of Transportation Studies; University of California, Davis

**Gary C. Thomas**, President and Executive Director, Dallas Area Rapid Transit, Dallas, Texas

**Phillip A. Washington**, General Manager, Regional Transportation District, Denver, Colorado

\* Membership as of June 2013.

**Rebecca M. Brewster**, President and COO, American Transportation Research Institute, Marietta, Georgia (ex officio)

**Anne S. Ferro**, Administrator, Federal Motor Carrier Safety Administration, U.S. Department of Transportation (ex officio)

**LeRoy Gishi**, Chief, Division of Transportation, Bureau of Indian Affairs, U.S. Department of the Interior, Washington, D.C. (ex officio)

**John T. Gray II**, Senior Vice President, Policy and Economics, Association of American Railroads, Washington, D.C. (ex officio)

**Michael P. Huerta**, Administrator, Federal Aviation Administration, U.S. Department of Transportation (ex officio)

**David T. Matsuda**, Administrator, Maritime Administration, U.S. Department of Transportation (ex officio)

**Michael P. Melaniphy**, President and CEO, American Public Transportation Association, Washington, D.C. (ex officio)

**Victor M. Mendez**, Administrator, Federal Highway Administration, U.S. Department of Transportation (ex officio)

**Robert J. Papp** (Adm., U.S. Coast Guard), Commandant, U.S. Coast Guard, U.S. Department of Homeland Security (ex officio)

**Lucy Phillips Priddy**, Research Civil Engineer, U.S. Army Corps of Engineers, Vicksburg, Mississippi, and Chair, TRB Young Members Council (ex officio)

**Cynthia L. Quarterman**, Administrator, Pipeline and Hazardous Materials Safety Administration, U.S. Department of Transportation (ex officio)

**Peter M. Rogoff**, Administrator, Federal Transit Administration, U.S. Department of Transportation (ex officio)

**David L. Strickland**, Administrator, National Highway Traffic Safety Administration, U.S. Department of Transportation (ex officio)

**Joseph C. Szabo**, Administrator, Federal Railroad Administration, U.S. Department of Transportation (ex officio)

**Polly Trottenberg**, Under Secretary for Policy, U.S. Department of Transportation (ex officio)

**Robert L. Van Antwerp** (Lt. General, U.S. Army), Chief of Engineers and Commanding General, U.S. Army Corps of Engineers, Washington, D.C. (ex officio)

**Barry R. Wallerstein**, Executive Officer, South Coast Air Quality Management District, Diamond Bar, California (ex officio)

**Gregory D. Winfree**, Acting Administrator, Research and Innovative Technology Administration, U.S. Department of Transportation (ex officio)

**Frederick G. (Bud) Wright**, Executive Director, American Association of State Highway and Transportation Officials, Washington, D.C. (ex officio)

## Board on Energy and Environmental Systems

### *Members*

Andrew Brown, Jr., NAE, Delphi Corporation, Troy, Michigan, *Chair*  
William F. Banholzer, NAE, Dow Chemical Company, Midland, Michigan  
William Cavanaugh III, NAE, Progress Energy (retired), Raleigh, North Carolina  
Paul A. DeCotis, Long Island Power Authority, Albany, New York  
Christine Ehlig-Economides, NAE, Texas A&M University, College Station  
Sherri Goodman, CNA, Alexandria, Virginia  
Narain G. Hingorani, NAE, Independent Consultant, San Mateo, California  
Robert Huggett, Independent Consultant, Seaford, Virginia  
Debbie Niemeier, University of California, Davis  
Daniel Nocera, NAS, Massachusetts Institute of Technology, Cambridge  
Margo Oge, Environmental Protection Agency (retired), McLean, Virginia  
Michael Oppenheimer, Princeton University, Princeton, New Jersey  
Jackalynne Pfannenstiel, Independent Consultant, Piedmont, California  
Dan Reicher, Stanford University, Stanford, California  
Bernard Robertson, NAE, Daimler-Chrysler (retired), Bloomfield Hills, Michigan  
Gary Rogers, FEV, Inc., Auburn Hills, Michigan  
Alison Silverstein, Consultant, Pflugerville, Texas  
Mark Thiemens, NAS, University of California, San Diego  
Richard White, Oppenheimer & Company, New York City  
Adrian Zaccaria, NAE, Bechtel Group (retired), Frederick, Maryland

### *Staff*

James Zucchetto, Senior Board/Program Director  
Dana Caines, Financial Associate  
David W. Cooke, Associate Program Officer  
Alan Crane, Senior Scientist  
K. John Holmes, Senior Program Officer/Associate Director  
LaNita Jones, Administrative Coordinator  
Alice V. Williams, Senior Program Assistant  
Jonathan Yanger, Senior Project Assistant

## **Board on Chemical Sciences and Technology**

### *Members*

**Pablo G. Debenedetti**, NAS/NAE, Princeton University, New Jersey, *Cochair*  
**Timothy Swager**, NAS, Massachusetts Institute of Technology, Cambridge, *Cochair*  
**David Bem**, The Dow Chemical Company, Midland, Michigan  
**Robert G. Bergman**, NAS, University of California, Berkeley  
**Joan Brennecke**, NAE, University of Notre Dame, Indiana  
**Henry E. Bryndza**, E. I. du Pont de Nemours & Company, Wilmington, Delaware  
**David W. Christianson**, University of Pennsylvania, Philadelphia  
**Richard Eisenberg**, NAS, University of Rochester, New York  
**Mary Jane Hagenson**, Chevron Phillips Chemical Company LLC (retired), The Woodlands, Texas  
**Carol J. Henry**, The George Washington University, Washington, D.C.  
**Jill Hruby**, Sandia National Laboratories, Albuquerque, New Mexico  
**Michael Kerby**, ExxonMobil Chemical Company, Baytown, Texas  
**Charles E. Kolb**, Aerodyne Research, Inc., Billerica, Massachusetts  
**Sander G. Mills**, Merck, Sharp, & Dohme Corporation, Kenilworth, New Jersey  
**David Morse**, NAE, Corning Incorporated, Corning, New York  
**Robert E. Roberts**, Institute for Defense Analyses, Alexandria, Virginia  
**Darlene Solomon**, Agilent Technologies, Santa Clara, California  
**Jean Tom**, Bristol-Myers Squibb, West Windsor, New Jersey  
**David Walt**, NAE, Tufts University, Medford, Massachusetts

### *Staff*

**Dorothy Zolandz**, Director  
**Kathryn Hughes**, Senior Program Officer  
**Douglas Friedman**, Program Officer  
**Amanda Khu**, Administrative Assistant  
**Rachel Yancey**, Senior Program Assistant





## **Committee for a Study of Pipeline Transportation of Diluted Bitumen**

**Mark A. Barteau**, NAE, University of Michigan, Ann Arbor, *Chair*  
**Y. Frank Cheng**, University of Calgary, Alberta, Canada  
**James F. Dante**, Southwest Research Institute, San Antonio, Texas  
**H. Scott Fogler**, University of Michigan, Ann Arbor  
**O. B. Harris**, O. B. Harris, LLC, Missouri City, Texas  
**Brenda J. Little**, Naval Research Laboratory, Stennis Space Center, Mississippi  
**Mohammad Modarres**, University of Maryland, College Park  
**W. Kent Muhlbauer**, WKM Consultancy, LLC, Austin, Texas  
**Srdjan Nešić**, Ohio University, Athens  
**Joe H. Payer**, University of Akron, Ohio  
**Richard A. Rabinow**, Rabinow Consortium, LLC, Houston, Texas  
**George W. Tenley, Jr.**, Hedgesville, West Virginia

### *National Research Council Staff*

**Thomas R. Menzies, Jr.**, Study Director, Transportation Research Board  
**Douglas Friedman**, Program Officer, Board on Chemical Sciences and Technology  
**Claudia Sauls**, Senior Program Assistant, Transportation Research Board

## Preface

This National Research Council (NRC) study was sponsored by the Pipeline and Hazardous Materials Safety Administration (PHMSA) of the U.S. Department of Transportation.<sup>1</sup> The study charge and origins are explained in Chapter 1. The contents and findings of the report represent the consensus effort of a committee of technical experts, who served uncompensated in the public interest. Drawn from multiple disciplines, the members brought expertise from chemistry and chemical engineering; corrosion and materials science; risk analysis; and pipeline operations, research, and safety regulation. Committee member biographical information is provided at the end of the report.

The study committee convened five times over 10 months, including a visit by several members to a pipeline terminal and energy research laboratory in the Edmonton and Fort McMurray areas of Alberta, Canada. Data-gathering activities during and between meetings were extensive. All but the final meeting contained sessions open to the public. During meetings, the committee heard from speakers from the oil and pipeline industries, environmental interest groups, research and standards organizations, oil testing companies, and government agencies from the United States and Canada. The committee also provided a forum for private individuals to contribute information relevant to the study. In sum, more than 40 people spoke before the committee during public meetings and site visits. To obtain additional information on the practice of transporting diluted bitumen by pipeline, the committee provided the Canadian Energy Pipeline Association with a questionnaire for distribution to pipeline operators with experience transporting diluted bitumen and other crude oils in North America. The questionnaire responses and agendas for the public meetings are provided in appendices to this report.

## ACKNOWLEDGMENTS

The committee thanks the many individuals who contributed to its work.

During data-gathering sessions open to the public, the committee met with the following officials from PHMSA: Jeffrey Wiese, Associate Administrator; Linda Daugherty, Deputy Associate Administrator for Policy and Programs; Alan Mayberry, Deputy Associate Administrator for Field Operations; Blaine Keener, National Field Coordinator; and Jeffery Gilliam, Senior Engineer and Project Manager. The contributions of all were appreciated, especially those of Mr. Gilliam, who served as PHMSA's technical representative for the project.

Several officials and researchers from government agencies and laboratories in Canada briefed the committee during meetings: Iain Colquhoun, National Energy Board; John Zhou, Alberta Innovates Energy and Environment Solutions; Haralampos Tsaprailis and Michael Mosher, Alberta Innovates Technology Futures; and Parviz Rahimi, Heather Dettman, and Sankara Papavinasam, Natural Resources Canada. The committee thanks them all, especially Dr. Papavinasam, who twice briefed the committee, and Dr. Tsaprailis, who arranged a tour of the Alberta Innovates and Natural Resources Canada energy laboratory in Devon, Alberta.

---

<sup>1</sup> The contract was awarded on March 12, 2012.

Early in its deliberations, the committee invited several nationally recognized experts to provide briefings on pipeline design, operations, and maintenance; corrosion evaluation and control; and developments in the North American petroleum market. The committee is indebted to Thomas O. Miesner, Pipeline Knowledge and Development; Arthur Diefenbach, Westpac Energy Group; Oliver Moghissi, DNV Columbus, Inc.; and Geoffrey Houlton, IHS. Their uncompensated briefings provided essential background for the committee's work.

The committee met with and received information from the following individuals representing the oil production and pipeline industries: Dale McIntyre, ConocoPhillips; Randy Segato, Suncor Energy, Inc.; Dennis Sutton, Marathon Petroleum Company; Bruce Dupuis, Jenny Been, and Bruce Wascherol, TransCanada Corporation; Colin Brown, Kinder Morgan Canada; Terri Funk and Shoab Nasin, Inter Pipeline; and Trevor Place, Ashok Anand, Martin DiBlasi, and Scott Ironside, Enbridge Pipelines, Inc. The committee expresses its gratitude to all, especially to Mr. Ironside, who assisted in arranging presentations and the tour of a pipeline terminal in Alberta.

In seeking information on the properties of diluted bitumen and other crude oils, the committee received valuable information from the following individuals and organizations: Harry Giles, Crude Oil Quality Association; Bill Lywood, Crude Quality, Inc.; and Andre Lemieux, Canadian Crude Quality Technical Association. The information received on the chemical and physical properties of diluted bitumen and other crude oils was critical to many of the analyses in the study. The committee thanks each of them and their organizations for this assistance.

Finally, the committee thanks several individuals who briefed it or were otherwise helpful in identifying issues and providing relevant sources of data and other information. They are Anthony Swift, Natural Resources Defense Council; Peter Lidiak, American Petroleum Institute; Cheryl Trench, Allegro Energy Consulting; and Ziad Saad, Canadian Energy Pipeline Association. Mr. Saad was instrumental in distributing and collecting responses to the pipeline operator questionnaire.

Thomas R. Menzies and Douglas Friedman were the principal project staff. Menzies managed the study and drafted much of the report under the guidance of the committee and the supervision of Stephen R. Godwin, Director, Studies and Special Programs, Transportation Research Board (TRB). Additional technical assistance and oversight were provided by James Zucchetto, Director of the Board on Energy and Environmental Systems, and Dorothy Zolandz, Director of the Board on Chemical Sciences and Technology. Norman Solomon edited the report, and Jennifer J. Weeks prepared the edited manuscript for prepublication web posting, under the supervision of Javy Awan, Director of Publications, TRB. Claudia Sauls provided extensive support to the committee in arranging its meetings and managing documents.

The report has been reviewed in draft form by individuals chosen for their diverse perspectives and technical expertise in accordance with procedures approved by NRC's Report Review Committee. The purpose of this independent review is to provide candid and critical comments that will assist the institution in making the report as sound as possible and to ensure that the report meets institutional standards for objectivity, evidence, and responsiveness to the study charge. The review comments and draft manuscript remain confidential to protect the integrity of the deliberative process.

NRC thanks the following individuals for their review of this report: Khalid Aziz (NAE), Stanford University; John Beavers, DNV Columbus, Inc.; Jos Derksen, University of Alberta; Melvin F. Kanninen (NAE), MFK Consulting Services; John Kiefner, Kiefner & Associates,

Inc.; Thomas Miesner, Pipeline Knowledge and Development; Gene Nemanich, Chevron Technology Ventures (retired); Stephen Pollock (NAE), University of Michigan; Massoud Tahamtani, Commonwealth of Virginia State Corporation Commission; and Patrick Vieth, Dynamic Risk USA, Inc. The review of this report was overseen by Elisabeth Drake (NAE), Massachusetts Institute of Technology, and Susan Hanson (NAS), Clark University. Appointed by NRC, they were responsible for making certain that an independent examination of this report was carried out in accordance with institutional procedures and that all review comments were carefully considered. Responsibility for the final content of the report rests solely with the authoring committee and the institution. Karen Febey managed the report review process under the supervision of Suzanne Schneider, Associate Executive Director, TRB.

# Contents

Executive Summary .....	1
<b>1 Introduction .....</b>	<b>3</b>
Study Charge.....	3
Study Scope .....	4
Analytic Approach .....	5
Report Organization.....	6
<b>2 Crude Oil Pipelines in the United States.....</b>	<b>8</b>
National Pipeline Network.....	8
Pipeline System Components .....	9
Operations and Control .....	11
Maintenance.....	12
Summary .....	13
<b>3 Bitumen Properties, Production, and Transportation by Pipeline .....</b>	<b>16</b>
Bitumen Composition and Properties .....	16
Bitumen Production .....	18
Pipeline Transportation of Diluted Bitumen.....	22
Summary .....	35
<b>4 Review of Pipeline Incident Data.....</b>	<b>37</b>
U.S. and Canadian Incident Data .....	37
State and Provincial Incident Data.....	45
Summary .....	47
<b>5 Assessing the Effects of Diluted Bitumen on Pipelines .....</b>	<b>49</b>
Sources of Internal Degradation .....	49
Sources of External Degradation .....	59
Sources of Mechanical Damage.....	63
Effects on Operations and Maintenance Procedures .....	65
Summary .....	67
<b>6 Summary of Results.....</b>	<b>70</b>
Recap of Study Charge and Approach.....	70
Main Points from Chapter Discussions.....	71
Study Results .....	74
<b>Appendices</b>	
<b>A Questionnaire to Pipeline Operators on Transporting Diluted Bitumen .....</b>	<b>76</b>
<b>B Federal Pipeline Safety Regulatory Framework.....</b>	<b>81</b>
<b>C Data-Gathering Sessions.....</b>	<b>86</b>
<b>Study Committee Biographical Information.....</b>	<b>89</b>

## Executive Summary

Legislation enacted in January 2012 called on the Secretary of Transportation to determine whether any increase in the risk of a release exists for pipelines transporting diluted bitumen.<sup>1</sup> Bitumen is a dense and viscous form of petroleum that will flow in unheated pipelines only when it is diluted with lighter oils. The source of the diluted bitumen in North America is the oil sands region of Alberta, Canada. Diluted bitumen has been imported from Canada for more than 30 years and is currently transmitted through numerous pipelines in the United States. As imports of this and other Canadian crude oils have grown, new U.S. pipelines have been constructed, the flow directions of several existing pipelines have been reversed, and additional pipeline capacity is planned.

Determination of the risk of a pipeline release requires an assessment of both the likelihood and the consequences of a release. To inform its review of the former, the U.S. Department of Transportation asked the National Research Council to convene an expert committee to study whether shipments of diluted bitumen differ sufficiently from shipments of other crude oils in such a way as to increase the likelihood of releases from transmission pipelines. A finding of increased likelihood would lead the committee to conduct a follow-up review of the adequacy of federal pipeline safety regulations. In the absence of such a finding, the committee was tasked with issuing this final report, which documents the study approach and results.

### STUDY APPROACH

The committee analyzed information in a variety of forms. Early in its deliberations, the committee provided a public forum for individuals to contribute information relevant to the study. The committee reviewed pipeline incident statistics and investigations; examined data on the chemical and physical properties of shipments of diluted bitumen and other crude oils; reviewed the technical literature; consulted experts in pipeline corrosion, cracking, and other causes of releases; and queried pipeline operators about their experience in transporting diluted bitumen.

The review of incident data revealed the ways in which transmission pipelines fail. Some failures can be affected by the properties of the transported crude oil, such as its water and sediment content, viscosity and density, and chemical composition. These properties were examined for diluted bitumen and a range of other crude oils to determine whether pipelines transporting diluted bitumen are more likely to experience releases. In addition, the committee considered whether pipeline operations and maintenance (O&M) practices, including internal and external corrosion control capabilities, are subject to changes that inadvertently increase the likelihood of release when pipelines transport diluted bitumen.

---

<sup>1</sup> Public Law 112-90, enacted January 3, 2012.

## RESULTS

### Central Findings

*The committee does not find any causes of pipeline failure unique to the transportation of diluted bitumen. Furthermore, the committee does not find evidence of chemical or physical properties of diluted bitumen that are outside the range of other crude oils or any other aspect of its transportation by transmission pipeline that would make diluted bitumen more likely than other crude oils to cause releases.*

### Specific Findings

*Diluted bitumen does not have unique or extreme properties that make it more likely than other crude oils to cause internal damage to transmission pipelines from corrosion or erosion. Diluted bitumen has density and viscosity ranges that are comparable with those of other crude oils. It is moved through pipelines in a manner similar to other crude oils with respect to flow rate, pressure, and operating temperature. The amount and size of solid particles in diluted bitumen are within the range of other crude oils and do not create an increased propensity for deposition or erosion. Shipments of diluted bitumen do not contain higher concentrations of water, sediment, dissolved gases, or other agents that cause or exacerbate internal corrosion, including microbiologically influenced corrosion. The organic acids in diluted bitumen are not corrosive to steel at pipeline operating temperatures.*

*Diluted bitumen does not have properties that make it more likely than other crude oils to cause damage to transmission pipelines from external corrosion and cracking or from mechanical forces. The contents of a pipeline can contribute to external corrosion and cracking by causing or necessitating operations that raise the temperature of a pipeline, produce higher internal pressures, or bring about more fluctuation in pressure. There is no evidence that operating temperatures and pressures are higher or more likely to fluctuate when pipelines transport diluted bitumen than when they transport other crude oils of similar density and viscosity. Furthermore, the transportation of diluted bitumen does not differ from that of other crude oils in ways that can lead to conditions that cause mechanical damage to pipelines.*

*Pipeline O&M practices are the same for shipments of diluted bitumen as for shipments of other crude oils. O&M practices are designed to accommodate the range of crude oils in transportation. The study did not find evidence indicating that pipeline operators change or would be expected to change their O&M practices in transporting diluted bitumen.*

In accordance with the study charge, these results focus on whether pipeline shipments of diluted bitumen have a likelihood of release greater than that of other crude oils. As indicated at the outset of this summary, the committee was not asked or constituted to study whether pipeline releases of diluted bitumen and other crude oils differ in consequences or to determine whether such a study is warranted. Accordingly, the report does not address these questions and should not be construed as having answered them.



## Introduction

This chapter describes the study charge and scope, analytic approach, and report structure.

### STUDY CHARGE

Section 16 of the Pipeline Safety, Regulatory Certainty, and Job Creation Act of 2011 calls for the Secretary of Transportation to “complete a comprehensive review of hazardous liquid pipeline facility regulations to determine whether the regulations are sufficient to regulate pipeline facilities used for the transportation of diluted bitumen. In conducting the review, the Secretary shall conduct an analysis of whether any increase in the risk of a release exists for pipeline facilities transporting diluted bitumen.”<sup>1</sup>

Bitumen is a dense and viscous form of petroleum that will flow through unheated pipelines only when it is diluted with lighter oils. At present, the source of bitumen supplied to refineries in North America is the oil sands region of Alberta, Canada. Bitumen from Canada has been diluted for pipeline transportation to the United States for more than 30 years, primarily to refineries located along the Great Lakes and elsewhere in the Midwest. Bitumen production and imports from Canada have grown during the past decade, and this traditional U.S. oil-processing market no longer has the capacity to refine all of the supply. Meanwhile, refineries on the Gulf Coast, which have traditionally processed South American and Mexican crude oils with properties similar to bitumen, have sought access to the heavy crude oils from Canada. To accommodate the Canadian imports as well as the growth in domestic crude oil production, the flow directions of several existing pipelines have been reversed, new transmission pipelines have been constructed, and additional pipeline capacity is planned.

Within the U.S. Department of Transportation (USDOT), the regulation of pipeline safety resides with the Pipeline and Hazardous Materials Safety Administration (PHMSA). USDOT has thus delegated to PHMSA the responsibility of determining whether pipelines transporting diluted bitumen have an increased risk of release. A determination of risk requires an assessment of both the likelihood and the consequences of a release. To inform its assessment of the former, PHMSA contracted with the National Research Council (NRC) to conduct the study documented in this report. Specifically, PHMSA asked NRC to convene a committee of experts in pipeline operations; risk analysis; safety regulation; and chemical, materials, and corrosion engineering to “analyze whether transportation of diluted bitumen by transmission pipeline has an increased likelihood of release compared with pipeline transportation of other crude oils.” PHMSA did not ask NRC to study the consequences of potential pipeline releases of diluted bitumen.

The full statement of task (SOT) for the study is contained in Box 1-1. The SOT calls for a two-phase study, with the conduct of the second phase contingent on the outcome of the first. In the first phase, the study committee is asked to examine whether shipments of diluted bitumen can affect transmission pipelines and their operations so as to increase the likelihood of release

---

<sup>1</sup> Public Law 112-90, enacted January 3, 2012.

## Box I-1

**Statement of Task**

The committee will analyze whether transportation of diluted bitumen (dilbit) by transmission pipeline has an increased likelihood of release compared with pipeline transportation of other crude oils. Should the committee conclude that an increased likelihood of release exists, it will review the federal hazardous liquid pipeline facility regulations to determine whether they are sufficient to mitigate the increased likelihood of release.

In the first phase of the project, the committee will examine whether dilbit can affect transmission pipelines and their operations so as to create an increased likelihood of release when compared with other crude oils transported through pipelines. Should the committee conclude there is no increased likelihood of release or find there is insufficient information to reach such a conclusion, a second phase of the project will not be required and the committee will prepare a final report to the Office of Pipeline Safety (OPS) of the Pipeline and Hazardous Materials Safety Administration (PHMSA). This report may include recommendations for improving information to assess the likelihood of failure.

Should the committee conclude there is an increased likelihood of release on the basis of dilbit's effects on transmission pipelines and their operations, it will issue a brief Phase 1 report of its findings and then proceed to the second phase of the project to determine whether hazardous liquids pipeline regulations are sufficient to mitigate the increased likelihood of release. The committee's final report following completion of this second phase will contain the complete set of findings, conclusions, and recommendations of both project phases.

when compared with shipments of other crude oils transported by pipeline. In the potential second phase—to be undertaken only in case of a finding of increased likelihood—the committee is asked to review federal pipeline safety regulations to determine whether they are sufficient to mitigate an increased likelihood of release from diluted bitumen. If the committee does not find an increased likelihood of release or the information available is insufficient for a finding, the committee is expected to prepare a final report documenting the study approach and results.

**STUDY SCOPE**

The SOT makes reference to several terms that delineate the study scope and require explication. First, the SOT specifically requests an examination of “transmission” pipeline facilities. The pipelines in these facilities contain large-capacity pipe, usually 20 inches or more in diameter, and generally transport fluids over long distances under relatively high pressure (400 to 1,400 pounds per square inch). Transmission facilities also contain storage tanks, pumping equipment, and piping within terminals. Gathering pipelines used for collecting crude oil from production fields do not transport diluted bitumen in the United States and are not part of this study.

As used in the SOT, the term “diluted bitumen” does not define a single product composition or specific set of product or shipment properties. Blending bitumen with lighter oils to lower viscosity is the common method of transporting this form of petroleum by pipeline. The volume of bitumen in a pipeline shipment will vary with the diluent, as will the chemical and physical properties of the shipment. The Canadian diluted bitumen transported in transmission pipelines to the United States generally contains 50 to 75 percent bitumen by volume, with light oils constituting the remainder. These bitumen blends are the subject of this study. It is recognized that the source and composition of bitumen shipments may change depending on technological advances, diluent supplies, refinery demands, and other technical and economic developments.

Finally, the SOT asks the committee to examine whether pipelines transporting diluted bitumen have a higher likelihood of release than pipelines transporting “other crude oils.” Accordingly, the aim of this study is to determine whether shipments of diluted bitumen have a release history or specific properties associated with pipeline failures that lie outside the range of experience and properties represented by the full spectrum of crude oils transported by pipeline in the United States.

## ANALYTIC APPROACH

An assessment of release likelihood requires information on the potential sources of pipeline failure. PHMSA mandates the reporting of releases from U.S. transmission pipelines and categorizes each according to its immediate, or proximate, cause. Historically, about one-third of reported releases have involved corrosion damage (Figure 1-1). Other causes include outside force damage, such as an excavator striking a buried pipe, and faulty equipment, operator error, and deficiencies in welds and materials used in pipeline manufacturing and installation.

The committee reviewed U.S. and Canadian data on reported pipeline releases. The review provided insight into the main causes of releases, but the incident statistics alone could not be used to determine whether pipelines are more likely to experience releases when they transport diluted bitumen than when they transport other crude oils. Few incident records contain information on the type of crude oil released in an incident or document the properties of the shipments moved through the pipeline over time. Causal details are also limited. Incidents categorized as corrosion damage, for example, do not specify whether the damage occurred as a result of the action of microorganisms, in combination with stress cracking, or at sites of previous mechanical damage. Such detailed information is important in determining the causative role of the crude oils being transported in the pipeline, particularly for failures arising from cumulative and time-dependent degradation mechanisms such as corrosion and cracking.

Having identified the main causes of pipeline releases, the committee assessed each cause with respect to its potential to be affected by the chemical and physical properties of the transported crude oil. Consideration was given to specific shipment properties that can contribute to internal degradation, external degradation, and mechanical damage in pipelines. While the committee did not perform its own testing of crude oil shipments, information on many of the chemical and physical properties of diluted bitumen and other crude oils was obtained from public websites and assay sheets. Additional information was obtained from a review of government reports and technical literature, queries of oil producers and pipeline

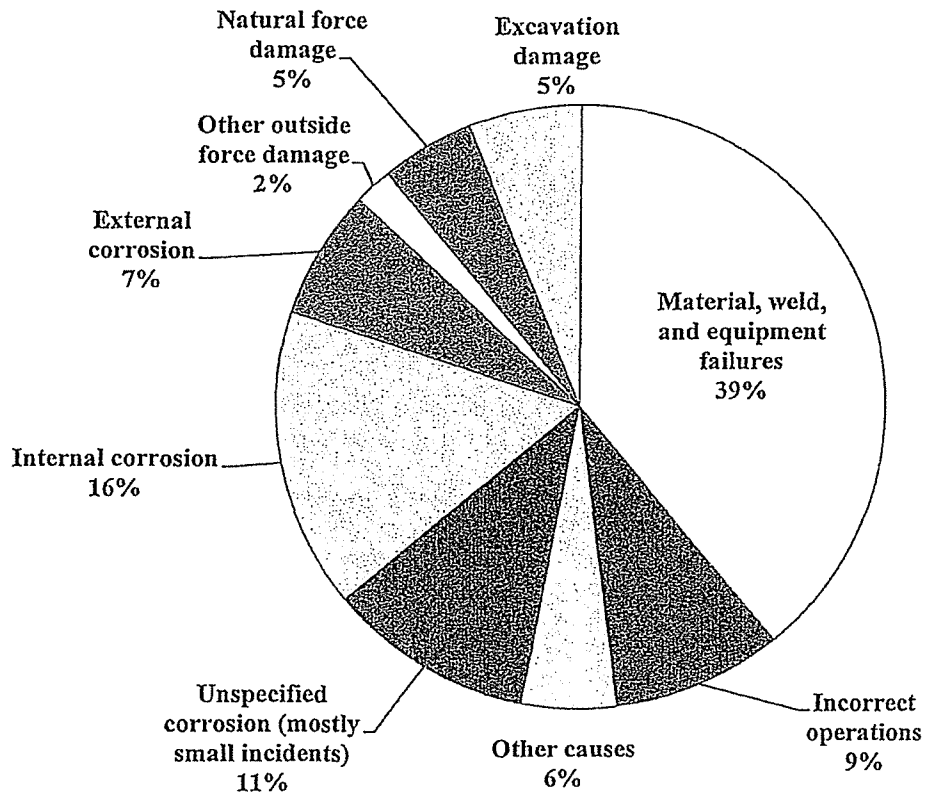

**FIGURE 1-1** Causes of crude oil pipeline releases reported to PHMSA, 2002 to 2011. (Source: Incident data provided to committee by PHMSA Office of Pipeline Safety during presentations on October 23, 2012. <http://onlinepubs.trb.org/onlinepubs/dilbit/Keener102312.pdf>.)

operators, field visits, and inferences from secondary sources such as the maximum water and sediment content specified in pipeline tariffs. The committee then compared the relevant properties of diluted bitumen with the range of properties observed in other crude oils and looked for instances in which diluted bitumen fell outside or at an extreme end of the range.

Recognizing the possibility that some pipeline operators may modify their operating and maintenance practices when they transport diluted bitumen, the committee asked operators about their procedures in transporting diluted bitumen and other crude oils. The committee looked for evidence of changes in standard procedures, including corrosion monitoring and control practices, that could inadvertently make pipelines more susceptible to failure.

## REPORT ORGANIZATION

The remainder of the report is organized into five chapters. Chapter 2 provides background on the transportation of crude oil by pipeline, including the main components of pipeline systems

and common aspects of their operations and maintenance. Chapter 3 describes the production, properties, and pipeline transportation of diluted bitumen. Chapter 4 reviews pipeline incident data from the United States and Canada. The analyses of how the comparative properties of diluted bitumen and other crude oils pertain to sources of pipeline failure are carried out in Chapter 5. Chapter 6 summarizes the main discussion points from the preceding chapters and presents the study results.

Appendix A contains the questionnaire developed for pipeline operators and the responses. A brief description of the federal hazardous liquid pipeline regulations and PHMSA safety oversight is provided in Appendix B. Agendas from the information-gathering sessions of committee meetings are provided in Appendix C.

## Crude Oil Pipelines in the United States

This chapter provides background on the network of crude oil transmission pipelines in the United States; the main components of these systems; and common aspects of their operations, maintenance, and integrity management. The background was derived from several sources: National Petroleum Council 2011, Argonne National Laboratory 2008, Rabinow 2004, and a presentation to the committee by Thomas Miesner.<sup>1</sup>

### NATIONAL PIPELINE NETWORK

Crude oil is transported, both onshore and offshore, in gathering systems and transmission pipelines. The gathering systems are made up of low-capacity pipelines—typically less than 8 inches in diameter—that move crude oil from wells to high-capacity transmission pipelines that are usually 8 to 48 inches in diameter. Before the crude oil leaves the production field, it is processed to remove excess water, gases, and sediments as necessary to meet the quality specifications of transmission pipelines and the refineries they access.

Most of the estimated 55,000 miles of crude oil transmission pipeline in the United States are interconnected to form a national network that links oil production regions, storage hubs, and refineries.<sup>2</sup> This extensive network accounts for more than 90 percent of the ton-mileage of crude oil transported within the United States.<sup>3</sup>

Transmission pipelines are critical in providing refineries with a steady supply of feedstock consisting of various types of crude oil. About 140 refineries operate nationwide. Some are vast complexes that can process more than 500,000 barrels of crude oil per day, while others serve relatively small and specialized markets and process less than 50,000 barrels per day.<sup>4</sup>

About 40 percent of U.S. refining capacity is located along the Gulf Coast, and the next largest center is in the Upper Midwest. Originally, the Gulf Coast refineries were supplied by domestic sources, primarily from Texas and Louisiana and from shallow waters in the Gulf of Mexico. As domestic production declined in the 1970s, the Gulf Coast refineries increasingly sourced their crude oil from Mexico, Venezuela, and the Middle East. Because the imports tended to be denser and higher in sulfur, refiners invested in facilities capable of processing such feedstock. In recent years, increased production from Canada, deep Gulf waters, and domestic shale fields has replaced waterborne imports. These supply shifts have had significant implications for the transmission pipelines that once moved crude oil from Gulf Coast ports to inland refineries as far north as Illinois and Ohio. Many of these systems have had their flow directions reversed and are now being used to transport Canadian crude oil to the Gulf Coast

---

<sup>1</sup> October 23, 2012 (<http://onlinepubs.trb.org/onlinepubs/dilbit/Miesner102312.pdf>).

<sup>2</sup> The Pipeline and Hazardous Materials Safety Administration (PHMSA) has estimated that the crude oil transmission pipeline network extended for 55,330 miles as of 2011.

<sup>3</sup> “Ton-mile” is a measure of the weight of a substance carried multiplied by the distance over which it is carried.

<sup>4</sup> One U.S. barrel of crude oil contains 42 gallons.

refineries. The transition is under way, with major investments to add more north-to-south capacity by reversing more lines and building new ones.

For many decades, U.S. crude oil produced in the northern Rocky Mountains and Dakotas, as well as that produced in the western provinces of Canada, was transported to refining centers in Eastern Canada and the Upper Midwest. In recent years, as output from these oil-producing regions has grown significantly, crude oil supplies have exceeded refining capacity and are being transported south, where they are displacing crude oil traditionally sourced from Mexico, South America, and the Gulf of Mexico.

Both the East and West Coasts have remained largely independent markets for crude oil supplies. The eastern states have little oil production and no significant crude oil transmission pipelines. While the recent development of shale resources in New York and Pennsylvania is adding production capacity, truck and rail remain the dominant regional modes of crude oil transportation. The main East Coast refining centers in northern New Jersey, Philadelphia, and coastal Virginia receive most of their supplies from tanker vessels. In comparison, California has an extensive network of crude oil transmission pipelines because of significant in-state oil production. These pipeline systems, some of which consist of heated lines to move the native viscous crude oils, do not connect to pipeline systems in other states. Refineries in Washington State receive crude oil by tanker and from Western Canada by pipeline.

## PIPELINE SYSTEM COMPONENTS

The individual pipeline systems that make up the U.S. crude oil transmission network vary in specific design features and components. Nevertheless, the systems have many common elements.

### Line Pipe

Pipelines are made of sections of line pipe that are welded together and generally buried 3 or more feet below grade. Virtually all line pipe is made of mild carbon steel that is coated externally but not internally. Pipe sections are typically 40 feet long, manufactured with longitudinally welded seams and joined by circumferential girth welds during installation. Pipe wall thickness depends on many factors, including planned capacity and operating pressure. Most line pipe in crude oil transmission systems is operated at pressures between 400 and 1,400 pounds per square inch, is 20 or more inches in diameter, and has a nominal wall thickness ranging from 0.2 to 0.75 inches. Federal regulations in the United States require that pipeline operating pressures and other forces not generate stresses that exceed 72 percent of the specified minimum yield strength (SMYS) of the pipe, and therefore a higher operating pressure requires thicker pipe or pipe with higher yield strength.<sup>5</sup> Depending on pipeline design and routing factors, thicker-walled pipe may also be used where the pipeline crosses a body of water or in areas that are densely populated, environmentally sensitive, or prone to additional external forces such as seismic activity.

---

<sup>5</sup> Federal regulations concerning SMYS are contained in 49 CFR §195.406. The federal hazardous liquid pipeline safety regulations, as administered by PHMSA, are outlined in Box B-1, Appendix B. Some pipelines operate at 80 percent of SMYS with permission of PHMSA.

### **Inlet Stations and Tank Farms**

Transmission pipelines originate at one or more inlet stations, or terminals, where custody of the shipment is transferred from the owner to the pipeline operator. Accordingly, inlet stations are access points for truck tankers, railroad tank cars, and tanker vessels as well as other pipelines, including gathering lines connecting production areas. Along with pumping stations, sampling and metering facilities are located at inlets to ensure that the crude oils injected into the pipeline meet the quality control requirements of the pipeline operator and intended recipients. Metering instruments usually include densitometers and may include viscometers, which are used to measure density and viscosity, respectively.

Tanks at inlet stations are used to consolidate shipments into batches sized for main-line movement, blend crude oils to meet quality specifications, and schedule shipments according to the needs of refiners. Tanks can vary in capacity from tens of thousands to hundreds of thousands of barrels.<sup>6</sup> All are made of steel and are unpressurized. They are usually designed with floating roofs that rise and fall with the liquid level to limit hydrocarbon loss from vaporization and minimize emissions of volatile organic compounds. Tanks usually have lined floors and are inspected and cleaned periodically to remove any water and sediment settling to the floor.

### **Pump Stations**

To maintain desired flow rates, booster pumps are positioned at points along the pipeline at intervals of 20 to 100 miles depending on many factors, including topography, line configuration, pipe diameter, operating pressure, and the properties of the fluids being transported. Pump stations are often automated and are equipped with sensors, programmable logic controllers, switches, alarms, and other instrumentation allowing the continuous monitoring and control of the pipeline as well as its orderly shutdown if an alarm condition occurs or if established operating parameters are violated.

### **Valves**

Shutoff valves are strategically located at pump stations, certain road and water crossings, and other points to facilitate the starting and stopping of flow and to minimize the impact of leaks. These valves, many of which can be controlled remotely, ensure that portions of the line can be isolated in the event of a leak or the need for repair or maintenance. In addition, check valves that prevent backflows may be located at elevation changes and other intermediate points. The opening and closing of valves, along with pumping station operations, are sequenced to prevent flow reversals and problems associated with over- and underpressurization. Bypass lines, safety valves (e.g., pressure and thermal relief), and surge tanks may be sited at stations to relieve pressure.

### **Intermediate and Terminal Facilities**

Depending on the scope of operations, a transmission pipeline system may have intermediate points, in addition to terminal facilities, that connect to other pipelines, other modes of transport,

---

<sup>6</sup> Larger underground caverns are used for storage at some pipeline terminals.



and refineries. These stations usually contain tanks and crude oil sampling and metering facilities. Smaller “breakout” tanks at intermediate points may also be used to support maintenance and emergency activities; for example, to relieve pressure or to allow for temporary draining of a pipeline segment.

## OPERATIONS AND CONTROL

### Batch Operations

A transmission pipeline will rarely carry a single type of crude oil. At any given time, a large pipeline will usually be transporting dozens of shipments, typically in batches of at least 50,000 barrels and covering a variety of crude oil grades. Sometimes the batches are physically separated by plugs known as pigs, but most of the time they are not. To reduce undesirable mixing at interfaces, the batches are separated and sequenced according to characteristics such as density, viscosity, and sulfur content. Accordingly, batches are scheduled to permit the proper lineup of crude oils being moved into and out of storage tanks. Maintaining batch separation requires that operators closely monitor the flow characteristics of the pipeline, since reductions in flow velocity and loss of flow turbulence can lead to undesirable intermixing of batches.

### Flow Regime

Most shipments flow through the pipeline at 1.5 to 3 meters per second (3 to 6 miles per hour), which equates to a delivery rate of 500,000 to 1,000,000 barrels of crude oil per day in a 36-inch transmission pipeline.<sup>7</sup> Flow conditions in the pipeline will remain turbulent within this range of flow velocities.<sup>8</sup> Pipeline operators strive to maintain turbulent flow, characterized by chaotic motion and the formation of eddies, to reduce intermixing of batches and to keep impurities such as water and sediment suspended in the crude oil stream. Choosing a desired flow regime requires the balancing of many technical and economic factors. Increasing operating pressure will increase pipeline throughput, which is generally desired by an operator to increase revenue capacity. Higher operating pressures, however, require a larger investment in pipe materials and pumping capacity and will increase energy use and operating costs.

The characteristics of the crude oil to be shipped are important considerations in establishing the flow regime. More energy is needed to pump dense, viscous crude oils than light crude oils with lower viscosity. Some crude oils are too viscous naturally to be pumped. The normal response when a highly viscous crude oil is transported is to dilute it with lighter oil. When a diluent is too costly or unavailable, an alternative approach is to transport the crude oil in a heated pipeline. However, heating a pipeline is an expensive option and presents construction

---

<sup>7</sup> <http://www.aopl.org/aboutPipelines/?fa=faqs>.

<sup>8</sup> Whether a flow is turbulent or nonturbulent (i.e., laminar) depends on the diameter of the pipeline, the velocity of the flow, and the viscosity of the crude oil. These parameters can be used to calculate the Reynolds number, which defines the flow regime as laminar to turbulent. As described later in Chapter 3, the kinematic viscosity of heavy crude oils can range up to about 250 centistokes (0.00025 square meter per second) at room temperature. These oils will need to be transported at about 2 meters per second (6.5 feet per second or 4.4 miles per hour) in a pipe with a diameter of 20 inches to achieve a Reynolds number higher than 4,000, which is at the transition from laminar to turbulent flow. In a larger pipe, lower velocities are required to maintain turbulence (e.g., 1 meter per second or 2 miles per hour for a 42-inch pipe). Further consideration is given to the beneficial effects of maintaining turbulent flow in Chapter 5.

and operating challenges that preclude its common use. Where the throughput capacity of a line needs to be increased without adding pumping capacity, an operator may inject drag-reducing agents to enhance flow. These chemicals, which consist of long-chain polymers, dampen turbulence at the interface between the crude oil and the pipe wall to reduce friction and enable increased flow velocity.

Pipeline flows are usually monitored and controlled by operators from one or more central control centers, where supervisory control and data acquisition systems collect and analyze data signals from sensors and transmitters positioned at pumps, valves, tanks, and other points en route. Parameters other than flow rate, such as line pressure, pump discharge pressures, and temperatures, are also monitored for routine operational and maintenance decisions and for leak detection.

### **Shipment Quality Control**

In the United States, the Federal Energy Regulatory Commission (FERC) oversees the tariffs that interstate pipeline operators are required to publish as common carriers. For intrastate transmission pipelines, state authorities such as the Texas Railroad Commission and the California Energy Commission function much like FERC in overseeing tariffs for in-state movements.

Pipeline tariffs define the terms and conditions for the transportation service, including the quality specifications applicable to all shipments in the pipeline. The specifications are driven by both operational and commercial considerations. Measurements to ensure adherence to the specifications are usually taken at custody transfer points. It is common for these specifications to define the maximum allowable sediment and water content, viscosity, density, vapor pressure, and temperature of the shipment. Other shipment qualities, such as levels of sulfur, acid, and trace metals, are seldom delineated in published tariffs but may be specified in private agreements. Quality specifications are designed to protect the integrity of the pipeline and the ancillary facilities, ensure that the shipped crude oil meets the specifications of the refiner, and prevent valuable throughput capacity from being consumed by transporting sediment and water.

## **MAINTENANCE**

Each operator tailors pipeline maintenance and integrity management practices within the parameters allowed by safety regulations and according to the demands of the specific system, including its age, construction materials, location, and stream of products transported. Nevertheless, many practices are standardized. Some of the most common cleaning, inspection, and mitigation practices are described below. Regulatory requirements that govern integrity management are outlined in Appendix B.

### **Cleaning**

Periodic cleaning of crude oil pipelines and equipment is often performed to facilitate inspection as well as to maintain operational performance. Cleaning intervals, typically measured in weeks or months, will vary depending on operating conditions and crude oil properties. A variety of tools are used for cleaning the pipe and monitoring interior condition. Mechanical pigs equipped

with scrapers and brushes remove debris from the inner wall. The scraped deposits and scale are transported to clean-out traps. The scrapings may be tested for contaminants and corrosion by-products.

### **Inspection and Monitoring**

A regular inspection regime that assesses the condition of rights-of-way, pipes, pumps, valves, tanks, and other components is important to maintaining pipeline operational integrity and preventing unplanned shutdowns. Rights-of-way are routinely monitored by aerial patrols looking for threatening activities and encroachments and by field inspectors conducting detailed surveillance of line and equipment conditions. While visual inspection of buried pipe is not possible, pipes exposed for repair are usually inspected for evidence of mechanical damage or signs of degradation that may be indicative of problems elsewhere on the line.

From time to time, instrumented, or “smart,” pigs are run through the line to detect anomalies. The three primary instruments are geometry, metal loss, and crack tools. Geometry tools are normally equipped with mechanical arms that survey the pipe wall to detect dents and other geometry changes. Metal loss tools use either magnetic or ultrasonic technology. Crack tools are designed to detect cracks in the pipe body, especially those that are longitudinally oriented. The frequency of instrumented pig runs is determined by the risk management program of the operator, as influenced by government regulation. Some pipeline sections, mostly in older systems, are not configured to accept some instrumented pigs.

Other techniques for monitoring conditions inside the pipe include the use of corrosion coupons and electrical resistance probes. Coupons are steel samples inserted into the pipeline and periodically removed for examination. Because the coupons are weighed before and after the exposure, the amount of corrosion can be determined by weight loss. Electrical resistance probes inserted into the pipe provide information on the corrosivity of the stream. External corrosion is monitored primarily through the use of pipe-to-soil potential surveys, whereby the voltage is measured with respect to a reference electrode to determine whether adequate cathodic protection levels are present along the length of the pipeline. Techniques are also used to measure the voltage gradients in the soil above a protected pipeline to determine the size and location of coating defects. Coupons buried in the soil can supplement this external corrosion monitoring. In addition, coatings are inspected whenever portions of the pipeline are uncovered.

### **Corrosion Mitigation Practices**

It is standard practice for buried transmission pipelines to be coated externally to provide a physical barrier between the steel and the surrounding corrosive environment. Desired coating characteristics include low permeability to water and salts, strong adhesion to steel, and good abrasion resistance (Beavers and Thompson 2006). The coating also needs to be durable and resist chemical and thermal degradation at pipeline operating temperatures.

Pipeline coatings have improved over the past several decades. Along with cold and hot applied tapes, field-applied coatings made from coal tar, asphalt, and grease were the dominant systems used through the 1950s (Michael Baker Jr., Inc. 2008; Beavers and Thompson 2006). Because of nonoptimal conditions for field applications, early coatings often had poor adhesion characteristics, with pinholes and other imperfections. Some also exhibited degradation of the

polymers. After time in service, the coatings tended to become porous or to detach from the pipe surface.

During the 1960s and 1970s, fusion bonded epoxy (FBE) coatings were introduced. Unlike other coatings, FBE coatings are formed by heating a powder on the surface of the metal. The components of the powder melt and flow to initiate a cross-linking process. These heat-cured coatings exhibit good mechanical and physical properties, including adhesive strength and resistance to degradation, and they are widely used today.

Even a well-coated pipe may have imperfections and develop small holes in the coating that can expose the pipe to corrosion attack. To counter this effect, pipelines are fitted with cathodic protection systems. In some systems, the electrochemical potential of the pipe is reduced by galvanically coupling to sacrificial anodes typically made of magnesium, aluminum, or zinc alloys that will preferentially corrode instead of the pipe. Other systems employ an impressed current applied to the pipeline with the use of a power supply to lower the pipeline potential. The cathodic protection system is designed to supply enough current to a pipe to prevent external corrosion at defects or holes that form in the coating where the external environment can come in contact with the steel surface. Defects in coatings are especially problematic when the disbonded coating shields distribution of the cathodic current to the defect site. This shielding is most often associated with the impermeable tapes and shrink sleeves used on some older pipelines. An advantage of modern FBE systems is that they are permeable to ionic flow and thus do not shield the exposed sites from cathodic protection.<sup>9</sup>

Preventing the internal corrosion of pipes starts with basic quality control and operational procedures that limit the entry and accumulation of water and other contaminants. As noted above, transmission pipelines are typically constructed of steel with no internal coatings, so the transported product is in contact with the steel. While oil is not corrosive, even small amounts of contaminants such as water and salts in the oil can be corrosive if they are allowed to accumulate on the steel surface. Certain gases dissolved in the product stream, especially oxygen, hydrogen sulfide, and carbon dioxide, can also increase the rate of corrosion. Actions to mitigate internal corrosion include controlling ingress of air at pumps and other entry points, limiting water and sediment content, and chemical treatment of the crude oil stream.

The chemicals injected into the crude oil stream usually consist of a mixture of additives that inhibit corrosion by various means. The most common mixtures contain surfactant chemicals that adsorb onto the steel surface and provide a barrier between the corrosive water and pipe steel. Many surfactants confer additional benefits by reducing the surface tension at the oil-water interface, which keeps the water entrained in the flow rather than depositing on the pipe wall. Chemical additives may also have properties that repel the water from the pipe wall, neutralize acids, and act as biocides to help inhibit microbiologically influenced corrosion. The rates of flow in transmission pipelines are normally sufficient to prevent the deposition of contaminants and to sweep away deposits that settle to the pipe bottom. Areas of low flow, such as steep angles of elevation and sections of isolated piping (called dead legs), are vulnerable to water and sediment accumulation and subsequent internal corrosion. Because the hydrodynamic and chemical processes of water and sediment accumulation are well understood, models for

---

<sup>9</sup> Inspections performed on gas gathering lines equipped with an early generation FBE coating (from the mid-1970s) revealed that less than 0.2 percent of pipeline sections exhibited blistering of the coating despite some operating in temperatures as high as 76°C (170°F). Removal of the blistered coating revealed no underlying corrosion because of the permeability of FBE to cathodic fields (Boerschel 2010; Batallas and Singh 2008).

analysis are available to guide pipeline construction and operating parameters to decrease the tendency for accumulations and to identify areas of greatest vulnerability to corrosion.

Additional details on the mechanisms of pipeline damage and factors that contribute to them are discussed in Chapter 5.

## SUMMARY

The crude oil transmission network in the United States consists of an interconnected set of pipeline systems. Shipments traveling through the network often move from one pipeline system to another, sometimes being stored temporarily in holding tanks at terminals. Most operators of transmission systems are common carriers who do not own the crude oil they transport but provide transportation services for a fee. Few major transmission pipelines are dedicated to transporting specific grades or varieties of crude oil. They usually move multiple batches of crude oil, which are often provided by different shippers and include a range of chemical and physical properties. Crude oil shipments are treated to meet the quality requirements of the pipeline operator as well as the content and quality demands of the refinery customer.

Pipeline systems traverse different terrains and can vary in specific design features, components, and configurations. These differences require that each operator tailor operating and maintenance strategies to fit the circumstances of its systems in accordance with regulatory requirements. Nevertheless, the systems tend to share many of the same basic components and follow similar operating and maintenance procedures. Together, regulatory and industry standards, system connectivity, and economic demands compel both a commonality of practice and a shared capability of handling different crude oils.

## REFERENCES

- Argonne National Laboratory. 2008. *Overview of the Design, Construction, and Operation of Interstate Liquid Petroleum Pipelines*. Report ANL/EVS/TM/08-1. <http://www.ipd.anl.gov/anlpubs/2008/01/60928.pdf>.
- Batallas, M., and P. Singh. 2008. Evaluation of Anticorrosion Coatings for High Temperature Service. Paper 08039. Presented at 17th International Corrosion Conference, National Association of Corrosion Engineers International, Houston, Tex.
- Beavers, J. A., and N. G. Thompson. 2006. External Corrosion of Oil and Natural Gas Pipelines. *ASM Handbook, Vol. 13C, Corrosion: Environments and Industries*, pp. 1015–1025. <http://www.asminternational.org/content/ASM/StoreFiles/ACFAB96.pdf>.
- Boerschel, V. 2010. New Developments of Mid-TG-FBE Powder Coatings to Meet the Requirements of Pipe Coaters and Pipeline Owners. Paper 10012. Presented at 19th International Corrosion Conference, National Association of Corrosion Engineers International, Houston, Tex.
- Michael Baker Jr., Inc. 2008. *Pipeline Corrosion: Final Report*. U.S. Department of Transportation, Pipeline and Hazardous Materials Safety Administration, Office of Pipeline Safety, Washington, D.C., Nov. [http://primis.phmsa.dot.gov/gasimp/docs/FinalReport\\_PipelineCorrosion.pdf](http://primis.phmsa.dot.gov/gasimp/docs/FinalReport_PipelineCorrosion.pdf).
- National Petroleum Council. 2011. *Crude Oil Infrastructure*. Paper 1-7. Oil Infrastructure Subgroup of the Resource and Supply Task Group, Sept. 15. [http://www.npc.org/Prudent\\_Development-Topic\\_Papers/1-7\\_Crude\\_Oil\\_Infrastructure\\_Paper.pdf](http://www.npc.org/Prudent_Development-Topic_Papers/1-7_Crude_Oil_Infrastructure_Paper.pdf).
- Rabinow, R. A. 2004. *The Liquid Pipeline Industry in the United States: Where It's Been, Where It's Going*. Association of Oil Pipe Lines, Washington, D.C., April.

## Bitumen Properties, Production, and Transportation by Pipeline

This chapter describes the chemical composition and physical properties of bitumen, the methods used to produce it, and the properties of the bitumen shipments that are diluted for pipeline transportation to the United States.

### BITUMEN COMPOSITION AND PROPERTIES

Like all forms of petroleum, bitumen is a by-product of decomposed organic materials rich in hydrocarbons. According to the World Energy Council, bitumen deposits exist in about 20 countries, but the largest are in Canada, Kazakhstan, and Russia (WEC 2010, 123–150). Because only the Canadian bitumen is diluted for transportation by pipeline to the United States, it is the subject of the description in this chapter.<sup>1</sup>

Canadian bitumen deposits are concentrated in the Western Canadian Sedimentary Basin (WCSB), and particularly in the province of Alberta. Three regions in the WCSB have large reserves: the Athabasca, Peace River, and Cold Lake regions (Strausz and Lown 2003, 21). According to the government of Alberta, about two-thirds of the world reserves of recoverable bitumen are contained in the three regions, which total some 140,000 square kilometers (55,000 square miles) (ERCB 2012a). In some locations in Alberta, surface deposits are easy to spot, since the black bitumen is impregnated in sandstone along the sides of lakes and rivers. Most of the bitumen is not visible because it is deposited below the surface.

The bitumen-impregnated sands in the WCSB are referred to as bituminous sands, oil sands, and tar sands (Strausz and Lown 2003, 29). Canadians use the term oil sands, which is also used in this report. The typical composition of the WCSB oil sands is 85 percent sand and clay fines,<sup>2</sup> 10 percent bitumen, and 5 percent water by weight.<sup>3</sup> Oil sands also contain salts, trace gases, and small amounts of nonpetroleum organic matter.<sup>4</sup> These components exist together in a specific microstructure with a film of water that surrounds each sand and clay particle, and the bitumen surrounds the film, as shown in Figure 3-1. When freed from this microstructure, bitumen has a typical elemental composition of 81 to 84 percent carbon; 9 to 11 percent hydrogen; 1 to 2 percent oxygen, nitrogen, and other elements; and 4 to 6 percent sulfur, most of which is bound in the bitumen in stable (e.g., heterocyclic rings) hydrocarbon structures (Dettman 2012; Strausz et al. 2011; Gogoi and Bezbaruah 2002; Strausz and Lown 2003).

---

<sup>1</sup> Canada contains the vast majority of the natural bitumen in North America. According to the U.S. Geological Survey, bitumen deposits exist in the United States in several states, mainly in Utah, California, and Alabama. While commercial mining operations are being planned in Utah, many technical and economic challenges remain to exploit this resource (USGS 2006).

<sup>2</sup> The solid particles consist of sand grain minerals, mostly of quartz but also feldspar, mica, and chert. The solid particles also consist of clay minerals, mostly kaolinite and illites (Strausz and Lown 2003, 31–32).

<sup>3</sup> Up to 18 percent of the ore can be made up of bitumen (Strausz and Lown 2003, 62).

<sup>4</sup> The organic matter consists of humin, humic acids, fulvic acids, and chemiabsorbed aliphatic carboxylic acids (Strausz and Lown 2003, 29–32).

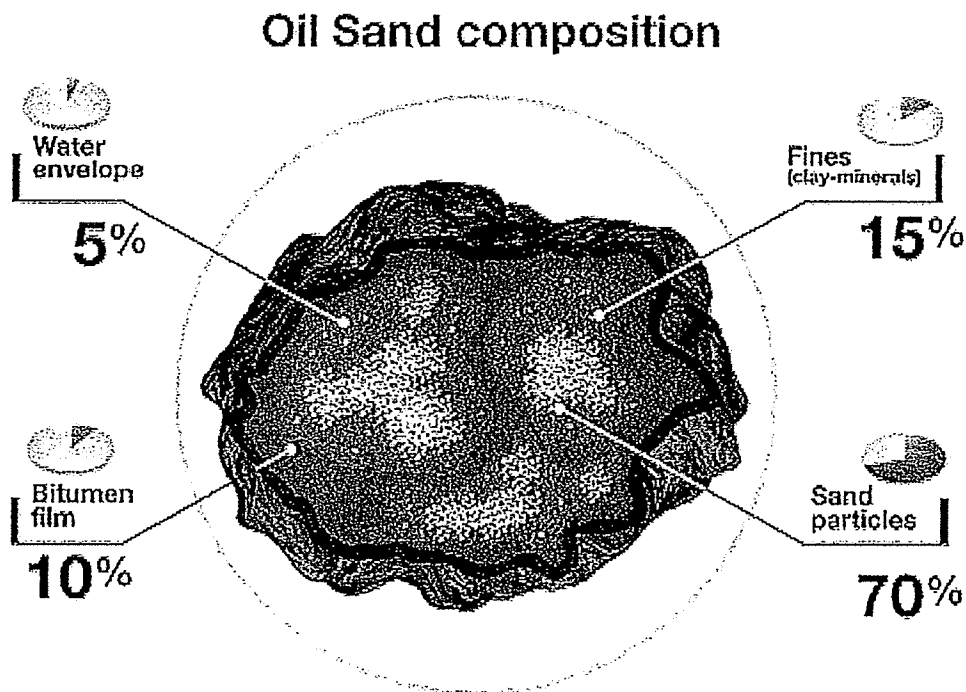

FIGURE 3-1 Composition of oil sands.

Hydrocarbon molecules account for 92 to 95 percent of the weight of bitumen.<sup>5</sup> These molecules range from light alkanes, such as ethane, to long-chain compounds with relatively high molecular weights and boiling points. The latter molecules are more common in bitumen than in the lighter, more paraffinic crude oils that have undergone less microbial degradation.<sup>6</sup> Bitumen contains relatively high concentrations of asphaltenes, which account for 14 to 17 percent of the total weight of the material (Strausz and Lown 2003, 95; Rahimi and Gentzis 2006, 151). Trace elements, such as vanadium and nickel, usually reside in the asphaltenes along with sulfur, nitrogen, and oxygen (Strausz and Lown 2003, 93–99, 495–498). The nitrogen in the bitumen is bonded with carbon in pyridinic structures, including quinolines and acridines (Rahimi and Gentzis 2006). The asphaltenes, as well as other nonparaffinic compounds such as naphthenes, give bitumen its high density and high viscosity (Strausz and Lown 2003, 99).

Bitumen is usually distinguished from other forms of petroleum on the basis of physical properties that derive in part from its relatively high asphaltene content. The U.S. Geological Survey (USGS) has used the following definition to distinguish bitumen from other heavy crude oils:

<sup>5</sup> The ratio of hydrogen to carbon atoms is about 1.5 in bitumen, compared with 2.0 for very light oils (Strausz and Lown 2003, 95–96).

<sup>6</sup> Bitumen has undergone more biodegradation than have other petroleum oils. Because straight-chain paraffinic hydrocarbons are more readily metabolized by microorganisms, these hydrocarbons are depleted in bitumen (Strausz and Lown 2003, 90).

Natural bitumen is defined as petroleum with a gas-free viscosity greater than 10,000 centipoises (cp) at original reservoir temperature. Petroleum with a gas-free viscosity between 10,000 and 100 cp is generally termed heavy crude oil. In the absence of viscosity data, oil with API gravity less than 10 degrees is generally considered natural bitumen, whereas oil with API gravity ranging from 10 degrees API to about 20 degrees API is considered heavy crude oil. The term extra-heavy crude oil is used for oil with a viscosity less than 10,000 cp but with API gravity less than 10 degrees. (USGS 2006)

The American Petroleum Institute (API) gravity scale referenced by USGS is an inverse measure of the density of a liquid relative to that of water at room temperature. A liquid with API gravity greater than 10 degrees will float on water; if the API gravity is lower than 10 degrees, it will sink.<sup>7</sup> Canadian bitumen (undiluted) typically has an API gravity between 7 and 13 degrees, whereas most heavy crude oils have values that are 5 to 15 degrees higher (Strausz and Lown 2003, 100). The viscosity of bitumen is also high compared with that of other crude oils across a range of temperatures. Figure 3-2 compares the effects of temperature on viscosity [in centipoise units (cp)] for bitumen derived from two WCSB reservoirs (Cold Lake and Athabasca), a Canadian heavy crude (Lloydminster), and typical light crude oils.<sup>8</sup> At most pipeline operating temperatures [0°C to 40°C (32°F to 100°F)], the lighter crude oils will behave as liquids, while the bitumen will remain in a semisolid state, having viscosities comparable with that of peanut butter. Although they are less viscous than bitumen, the heaviest conventionally drilled Canadian crude oils have relatively high viscosities as well.<sup>9</sup> Several Canadian crude oils, including the Lloydminster crude oils shown in Figure 3-2, are routinely diluted with lighter oils to improve their flow in transmission pipelines.<sup>10</sup>

## BITUMEN PRODUCTION

The WCSB has long been a major oil-producing region of North America. Oil exploration commenced in the early 20th century, and by the 1960s hundreds of millions of barrels of Western Canadian crude oil were being exported each year through pipelines to the United States. Nearly all of this oil was produced with conventional drilling and well technology. By the 1990s, Western Canadian exports of conventionally produced oil were declining just as new technologies were being introduced to recover the vast deposits of bitumen contained in oil sands.

---

<sup>7</sup> API gravity values are referred to as “degrees.” Most crude oils have API gravities in the range of 20 to 40 degrees, but some range 10 degrees higher or lower.

<sup>8</sup> Centipoise is a measure of resistance to shear flow, or the dynamic viscosity of a fluid. A more common measure of resistance to flow by crude oils is the centistoke (cSt), which is the ratio of dynamic viscosity to fluid density, also known as kinematic viscosity. At room temperature, the kinematic viscosity of bitumen will exceed 100,000 cSt, compared with about 25 cSt for a medium-density crude oil. Kinematic viscosity is referenced more often in this report.

<sup>9</sup> This Canadian heavy crude oil is usually diluted with lighter oils for pipeline transportation.

<sup>10</sup> Lloydminster heavy crude oils have API gravities of 12 to 23 degrees (Strausz and Lown 2003, 26).



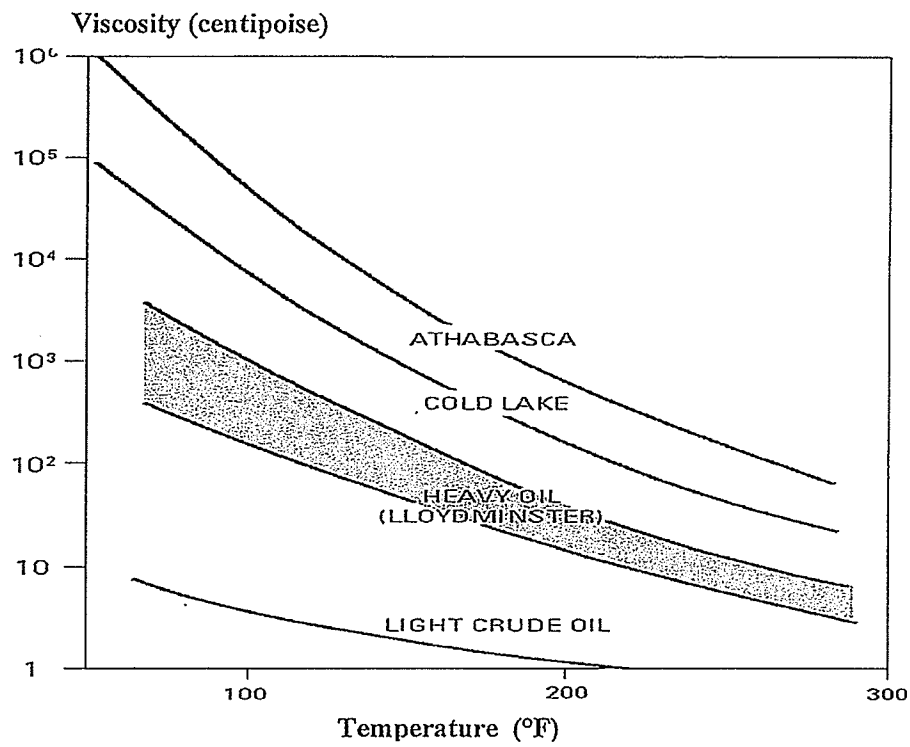

FIGURE 3-2 Response of crude oil viscosity to changes in temperature (Raicar and Procter 1984; WEC 2010, 126).

While natural bitumen had long been used as sealing material, Canadian entrepreneurs started mining deposits for refinery feed during the early 20th century. However, separating the bitumen from the mined ore required significant amounts of heated water, which made recovery expensive compared with the lighter crude oils that were less costly to drill elsewhere in Canada and the United States. Commercial ventures to mine bitumen began in the 1920s, but it took another 40 years of declining North American crude oil reserves, increasing consumer demand for gasoline and other refined petroleum, and advances in extraction and processing technologies to transform the mined bitumen into a commercially viable refinery feedstock.<sup>11</sup>

During the 1990s, thermally assisted in situ recovery methods were introduced in the WCSB to exploit the large reserves of bitumen located too deep for surface mining. After this development, the quantity of bitumen produced surpassed the quantity of conventionally produced oil from the basin. Today, bitumen accounts for more than 70 percent of the petroleum produced in Alberta, and in situ recovery methods account for nearly half of this bitumen production (ERCB 2012a).

<sup>11</sup> Oil Sands Discovery Centre. Facts About Alberta's Oil Sands and Its Industry. [http://history.alberta.ca/oilsands/docs/facts\\_sheets09.pdf](http://history.alberta.ca/oilsands/docs/facts_sheets09.pdf).

One in situ method in particular—steam-assisted gravity drainage (SAGD)—led to the recent growth in Canadian bitumen production for export to the United States. Indeed, no significant quantities of mined bitumen are diluted for pipeline transportation to the United States, the main market for bitumen recovered by using the SAGD process.<sup>12</sup>

### **Bitumen Mining and Upgrading to Synthetic Crude Oil**

About 20 percent of the bitumen deposits in the WCSB are less than 60 meters (200 feet) deep and can be recovered by surface mining. Mining operations use diesel-powered shovels to excavate the ore, which is transported by truck to field facilities containing crushers. The crushed ore is mixed, or washed, with hot water to create a slurry that is piped a short distance, where it is agitated and filtered in separation vessels. The hot water heats and releases the water that surrounds the sand and clay particles. The agitation causes air bubbles to attach to bitumen droplets, which float in a froth to the top of the vessel. The froth is then deaerated with steam and diluted with a hydrocarbon solvent such as naphtha. The solvent coalesces and causes settlement of emulsified water and mineral solids. The suspended bitumen is then separated with a centrifuge and skimmer.

The extraction process for mined bitumen yields a product that typically contains 0.5 percent solids and 1 to 2 percent water by volume. This solid and water content is generally too high to be accepted by transmission pipelines. As a consequence, mined bitumen is nearly always upgraded, usually at nearby field plants, into synthetic crude oil. The field plants consist of refinery-type cokers that crack the bitumen into lighter products that are then processed in hydrotreating units to remove sulfur and nitrogen.<sup>13</sup> The processed streams are then mixed to produce a low-viscosity, low-sulfur synthetic crude oil that can be transported by transmission pipeline to refineries in Canada and the United States. The synthetic crude oils are also blended with other heavy Canadian crude oils, including in situ-produced bitumen, for pipeline transportation to the United States.

Nearly all of the bitumen mined in the WCSB is upgraded to synthetic crude oil.<sup>14</sup> This situation is subject to change as alternative methods are introduced to yield mined bitumen with reduced viscosity and water and sediment content comparable with that of the bitumen produced in situ and transported in diluted form through transmission pipelines. One alternative is to deasphalt the mined bitumen partially to produce synthetic crude oil that retains some of the heavier hydrocarbon fraction by substituting a paraffinic solvent for the aromatic-rich naphtha solvent traditionally used during removal of water and solids (Rahimi et al. 1998). Composed largely of pentanes and hexanes, a paraffinic solvent is more effective than naphtha in promoting aggregation and settlement of asphaltenes and suspended water and solids. Removal of asphaltenes through paraffinic treatment yields a processed bitumen that is less viscous and has lower levels of water and solids than mined bitumen that is processed with a traditional naphtha solvent.

---

<sup>12</sup> The discussion focuses on surface mining and SAGD, which are the most common bitumen recovery methods. Other methods not discussed include cyclic steam stimulation, toe-to-heel air injection, vapor-assisted petroleum extraction, and cold heavy oil production with sand. More information on recovery methods can be found at <http://www.oilsands.alberta.ca/>.

<sup>13</sup> According to the Alberta Energy Ministry, the five upgraders operating in Alberta in 2011 had the capacity to process approximately 1.3 million barrels of bitumen per day (ERCB 2013).

<sup>14</sup> According to the Alberta Energy Ministry, in 2011 about 57 percent of oil sands bitumen production was upgraded to synthetic crude oil in Alberta. Most upgraders produce synthetic crude oil, but some also produce refined products such as diesel (ERCB 2013).

Mined bitumen processed with paraffinic solvent can be transported by transmission pipeline, usually by retaining some of the solvent as diluent.<sup>15</sup> Mined bitumen treated in this manner is being piped several hundred miles from oil sands production regions to large, centrally based upgraders elsewhere in Alberta, where it is processed into synthetic crude oil. The mined bitumen, however, is not transported through pipelines to the United States (except when upgraded to synthetic crude oil) because paraffinic solvents are too expensive to use as diluent for long-distance transportation. Instead, the solvent is recovered at the Canadian upgraders and piped back to bitumen production fields for reuse as a solvent.

### In Situ Recovery

Because most Canadian bitumen is located deep underground, it can only be recovered in place. Although reaching the deposits is not difficult,<sup>16</sup> the challenge in recovering them is in separating and thinning the bitumen for pumping to the surface. A recovery method that is now common involves the injection of pressurized steam into the deposit. The steam thins the bitumen and separates it from the sand while the pressure helps to push the bitumen up the well.

A number of thermally assisted recovery methods are used in the WCSB. The two main methods are cyclic steam stimulation (CSS) and SAGD. CSS involves injecting steam into the bitumen deposit and letting it soak for several weeks. This process causes the bitumen to separate from the sand and become sufficiently fluid for pumping. Over the past decade, SAGD has surpassed CSS as the preferred thermal recovery method because a higher proportion of the bitumen is recovered. SAGD involves drilling two horizontal wells, one located a few feet above the other as shown in Figure 3-3. Steam is injected into the upper well, which heats the bitumen and causes it and steam condensate to drain into the lower well for pumping to the surface. At the surface, condensed water is separated from the recovered bitumen and recycled to produce steam for subsequent applications.

The high recovery ratio of SAGD is an important reason for the growth in Canadian bitumen production. SAGD now accounts for about half the bitumen recovered from the WCSB.<sup>17</sup> Compared with mining, SAGD has the advantage of eliminating the need to wash the ore with hot water because the bitumen is separated from the sand and clay underground. After further treatment (e.g., standard degassing, dewatering, and desalting), the recovered bitumen contains much lower levels of water and sediments (generally less than 0.5 percent by volume) than mined bitumen, and it is sufficiently stable for acceptance by long-distance pipelines. Whereas nearly all mined bitumen is upgraded into synthetic crude oil in Alberta, less than 10 percent of the SAGD-derived bitumen is processed into synthetic crude oil (NEB 2009). Most SAGD-derived bitumen is diluted with lighter oils for transportation by pipeline to U.S. refineries.

---

<sup>15</sup> While asphaltene concentrations have significant implications for bitumen viscosity, the removal of all asphaltenes would not reduce viscosity enough for undiluted bitumen to meet pipeline specifications (Rahimi and Gentzis 2006).

<sup>16</sup> The exploited deposits are generally less than 750 meters (2,500 feet) underground.

<sup>17</sup> In 2011, about 1.7 million barrels per day of bitumen were produced, with surface mining accounting for 51 percent and in situ processes accounting for 49 percent of the production (ERCB 2013).

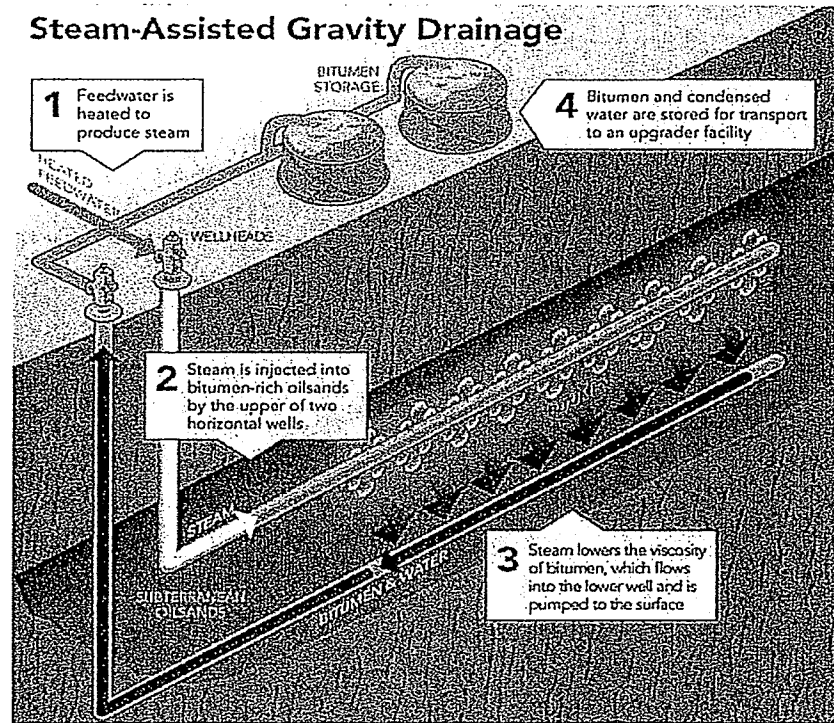

FIGURE 3-3 Bitumen recovered using SAGD (ERCB 2012b).

### PIPELINE TRANSPORTATION OF DILUTED BITUMEN

According to the U.S. Department of Energy, imports of Canadian diluted bitumen and other crude oils have grown by more than one-third since 2000.<sup>18</sup> Partially as a result of Canadian supplies as well as newly exploited domestic oil shale, crude oil imports from other regions of the world are declining. In particular, the Canadian feedstock has supplanted heavy crude oils once imported in large volume from Venezuela and Mexico (Figure 3-4). While more than two-thirds of the Canadian crude oil is refined in the Midwest, refinery demand for this feedstock has been growing in other regions of the country, particularly at Gulf Coast refineries that are equipped to process heavy feed.

### U.S. Pipelines Transporting Diluted Bitumen

Figure 3-5 shows U.S. refinery destinations for diluted bitumen and other Canadian crude oils, and Figure 3-6 shows the main pipeline corridors that access these refineries. Major export pipelines from Canada include the Enbridge Lakehead network, which serves several Great Lakes refineries; the TransCanada Keystone pipeline, which accesses the Cushing, Oklahoma, hub and refineries in southern and central Illinois; and the Kinder Morgan Express and Prairie

<sup>18</sup> <http://www.eia.gov/countries/cab.cfm?fips=CA>.

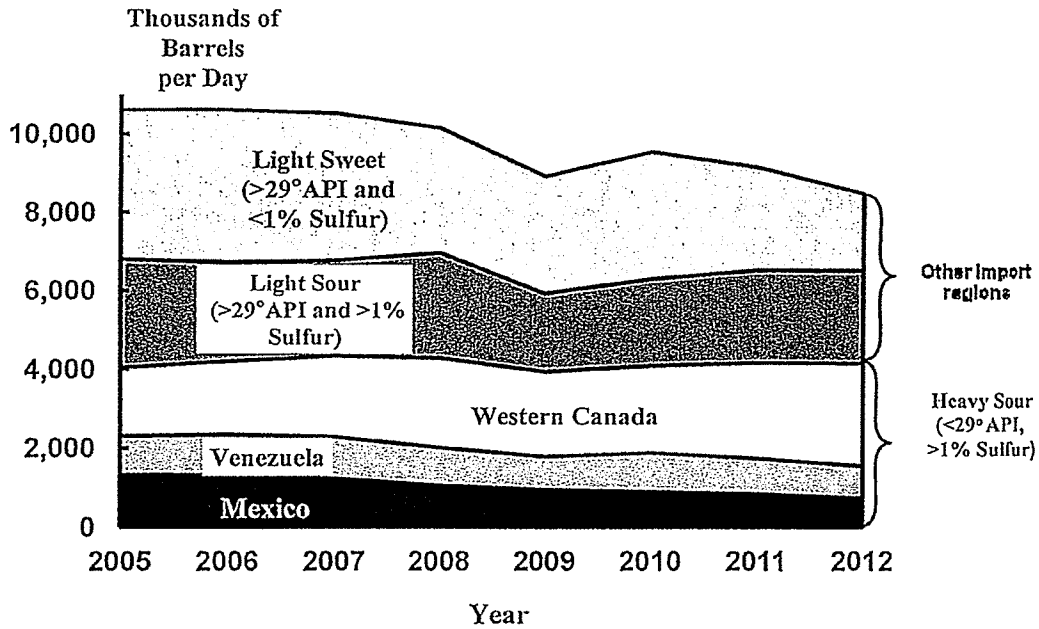

**FIGURE 3-4 Annual U.S. crude oil imports by grade and origin.** [Chart is derived from January 31, 2012, presentation to the committee by G. Houlton. Source data on crude oil imports were obtained from the Energy Information Administration, U.S. Department of Energy (<http://www.eia.gov/countries/cab.cfm?fips=CA>).]

pipelines, which transport Canadian crude oils to refineries in the Rocky Mountains and provide surplus to refineries farther east and south. These trunk lines are connected to pipelines that deliver feed to refineries as far east as Ohio and western Pennsylvania and as far south as the Texas Gulf Coast and New Mexico. Several connecting pipelines have recently undergone flow reversals, such as the 375-mile Occidental Centurion line, which now runs southwest from Cushing in the direction of El Paso, Texas; the 858-mile ExxonMobil Pegasus line, which runs south from Illinois to refineries on the Gulf Coast; and the 670-mile Enbridge Seaway line, which crosses East Texas and is expected to become fully operational during 2013.

**Properties of Diluted Bitumen Shipped by Pipeline**

In Canada, the National Energy Board (NEB) administers the tariffs, or terms and conditions, that govern the transportation of crude oil by transmission pipeline. For shipments entering the United States, pipeline operators must also file tariffs with the Federal Energy Regulatory Commission. As explained in Chapter 2, tariffs contain quality specifications for crude oil shipments that are intended to ensure compliance with the operational requirements of pipelines as well as possession of properties required by refiners. At custody transfer points, pipeline operators sample shipments to confirm compliance with tariff specifications.

### Density and Viscosity Levels

To ensure pipeline transportability, NEB tariffs specify that the density of crude oil shipments not exceed 940 kilograms per cubic meter ( $\text{kg/m}^3$ ) (about 20 degrees API gravity) and that viscosity not exceed 350 cSt<sup>19</sup> when measured at the posted pipeline operating temperature.<sup>20</sup> To meet the specifications, Canadian bitumen is diluted into either “dilbit” or “synbit.” The Canadian Association of Petroleum Producers describes dilbit as a bitumen blend consisting of diluent that has a density of less than  $800 \text{ kg/m}^3$  (45 degrees API). If it has a density greater than or equal to  $800 \text{ kg/m}^3$ , the diluent is presumed to be synthetic crude oil, and the blend is called synbit (CAPP 2013).

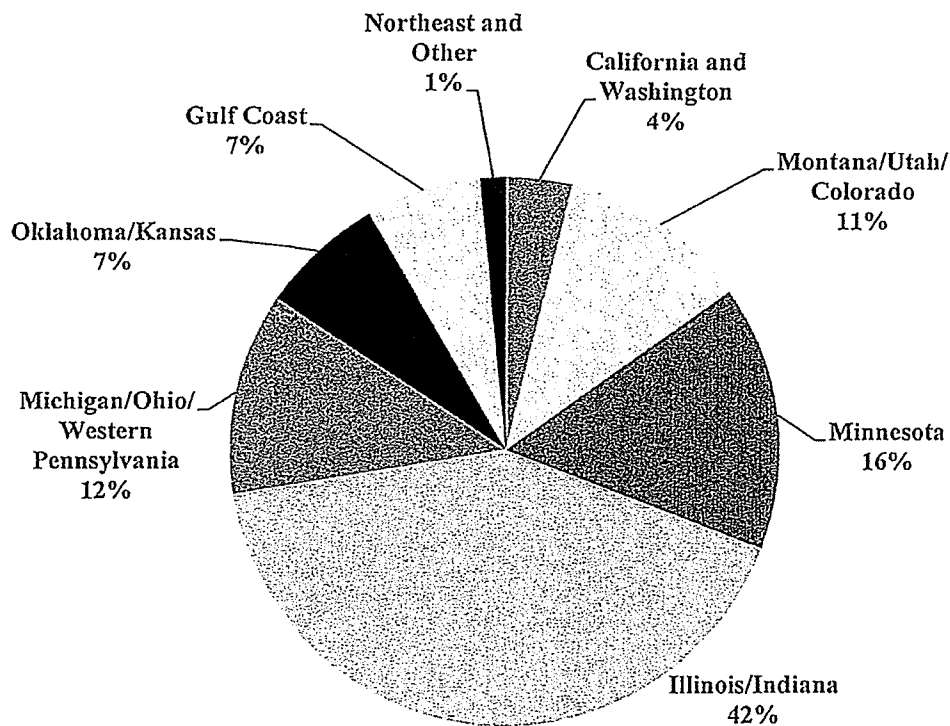

**FIGURE 3-5 U.S. refinery destinations for Canadian heavy crude oil imports in 2011.**  
 [Source: National Energy Board fact sheet “Disposition of Heavy Crude Oil and Imports” (<http://www.neb-one.gc.ca/clf-nsi/rnrgynfmetn/sttstc/crdlndptrlmprdct/dspstnfdmstccrdlndmpts-eng.html#s1>).]

<sup>19</sup> Kinematic viscosity and the centistoke (cSt) unit of viscosity measurement have been defined earlier in this chapter.

<sup>20</sup> For an example, see Article 1, page 3 (Definition for Heavy Crude) of NEB Tariff Number 4, Keystone Pipeline System Petroleum Tariff ([http://www.transcanada.com/docs/Key\\_Projects/06\\_NEB\\_Tariff\\_No\\_4\\_Rules\\_and\\_Regs\\_CL.pdf](http://www.transcanada.com/docs/Key_Projects/06_NEB_Tariff_No_4_Rules_and_Regs_CL.pdf)).

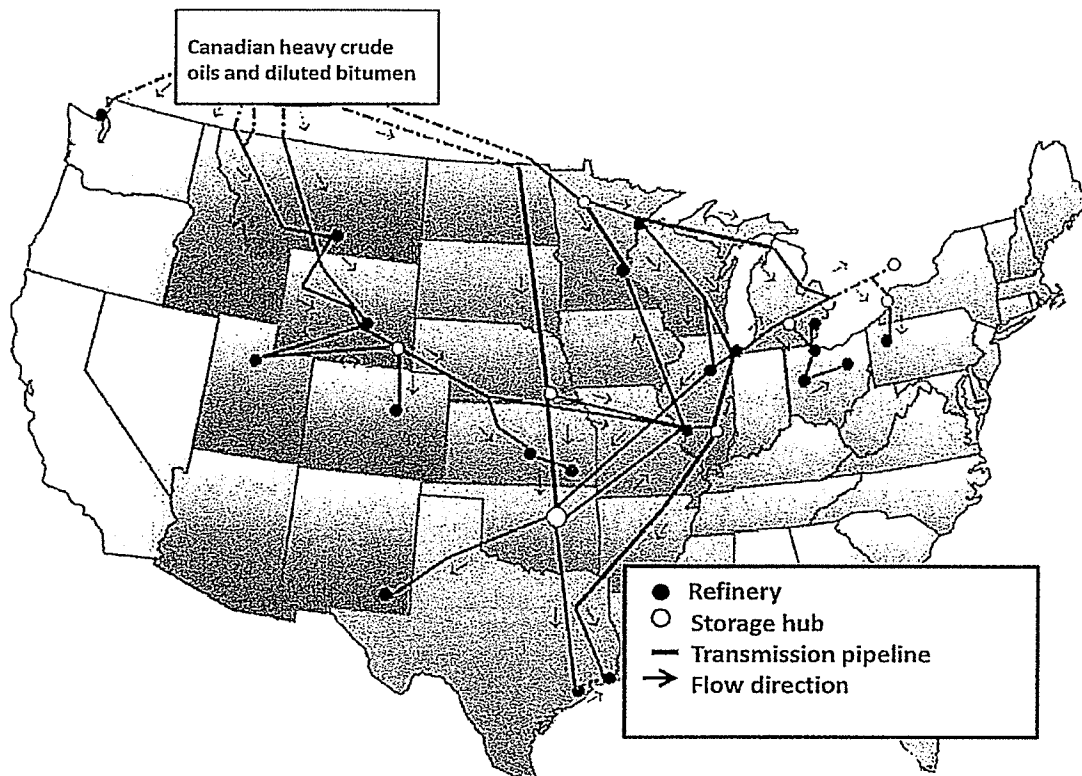

FIGURE 3-6 Main pipeline corridors moving Canadian crude oil to U.S. refineries.

In the case of dilbit, the most common diluents are naphtha-based oils, including natural gas condensate.<sup>21</sup> The light oils that are used have low densities ( $<750 \text{ kg/m}^3$ ), high API gravities ( $>60$  degrees), and low viscosities ( $<1 \text{ cSt}$  at room temperature). Compared with condensate, synthetic crude oils have higher densities ( $825$  to  $875 \text{ kg/m}^3$ ), lower API gravities ( $30$  to  $40$  degrees), and higher viscosities ( $5$  to  $20 \text{ cSt}$ ). Some bitumen shipments are diluted with both condensate and synthetic crude oil to produce “dilsynbit.”

Dilution and blending activity is common in the petroleum industry, as distillates and light oils are regularly mixed with heavier oils to alter shipment density and viscosity characteristics. The chemical compatibility of the oils and distillates must be considered before blending, particularly to avoid precipitation of asphaltenes. Thick deposits of these components can foul pipelines, pumps, and other equipment to create an increased need for pig cleaning to prevent flow assurance problems (Cimino et al. 1995; Saniere et al. 2004; Leontaritis and Mansoori 1988). Dilution with distillates containing high concentrations of light hydrocarbons such as pentanes and hexanes can cause asphaltenes to precipitate from oils if the distillate makes up a majority of the volume of the blend (Maqbool et al. 2009). The acceptable types and ratios of distillates blended with bitumen have therefore been analyzed to ensure chemical compatibility as well as a transportable product that does not deposit asphaltenes during postproduction storage and transportation (Schermer et al. 2004).

<sup>21</sup> Condensate liquid is produced from raw natural gas when the temperature is reduced below the boiling temperature of the gas.

As discussed earlier, distillates such as naphtha are usually mixed with bitumen at the production plant to facilitate water and sediment removal. Indeed, all or most of the diluent in diluted bitumen is blended during the processing stage before delivery of shipments for transmission by pipeline. In some cases, more diluent may be added after delivery to the transmission pipeline if further dilution is necessary to meet the density and viscosity levels required for long-distance transportation.<sup>22</sup> Like all crude oil blending, the mixing of diluent and bitumen is designed to make the shipped product miscible, or fully mixed in all proportions. As discussed in Chapter 2, once in the pipeline, batch shipments of diluted bitumen and other heavy crude oils are sequenced to avoid contact with lighter crude oil and condensate shipments. Meters along the pipelines track the batched stream to detect any changes in shipment density and viscosity.

After blending, diluted bitumen becomes a mixture of hydrocarbons with a range of molecular weights. As in the case of other crude oils, these hydrocarbons are separated by distillation at recipient refineries. Table 3-1 compares the distilled volume of light (low-molecular-weight) hydrocarbons in three diluted bitumen crude oils and five light, medium, and heavy crude oils imported from Canada. The light hydrocarbons in all crude oils are mainly

**TABLE 3-1 Percentage (by Volume) of Low-Molecular-Weight Hydrocarbons in Selected Diluted Bitumen Blends and Other Canadian Crude Oils**

	Access Western Blend  (Diluted Bitumen)	Wabasca Heavy  (Diluted Bitumen)	Borealis Heavy Blend  (Diluted Bitumen)	Koch Alberta  (Light Crude Oil)	Light Sour Blend  (Light Crude Oil)	Sour High Edmonton  (Medium Crude Oil)	Smiley- Coleville  (Heavy Crude Oil)	Lloyd Kerrobert  (Heavy Crude Oil)
Butanes	0.72	1.93	0.38	4.50	2.43	2.43	0.54	2.04
Pentanes	8.53	1.92	4.01	2.39	3.25	2.56	4.88	6.00
Hexanes	7.06	3.00	5.75	4.54	6.13	4.59	3.95	3.96
Heptanes	4.73	3.47	4.57	5.61	7.44	5.31	2.7	2.12
Octanes	2.74	3.53	5.28	6.09	8.72	5.58	2.12	1.38
Nonanes	1.43	2.64	4.04	4.97	7.18	4.60	2.05	1.36
Decanes	0.70	1.21	1.49	2.49	3.46	2.46	1.10	0.81
Total	25.91	17.7	25.52	30.59	38.61	27.53	17.34	17.67
Mass Recovered	Distillation Temperature °C (°F)							
5%	38 (101)	93 (200)	64 (147)	45 (114)	69 (156)	64 (147)	62 (144)	51 (123)
10%	70 (158)	152 (307)	93 (200)	92 (198)	87 (188)	93 (200)	114 (237)	136 (276)

SOURCE: Data obtained from CrudeMonitor.com by Crude Quality, Inc.  
(<http://www.crudemonitor.ca/condensate.php?acr=SLD>; <http://www.crudemonitor.ca/crude.php?acr=SYN>).  
Accessed March 1, 2013.

<sup>22</sup> Information on production processes was obtained from briefings by and interviews with bitumen producers and pipeline operators.



pentanes or heavier, with some measurable butanes and trace amounts of lighter molecules. Because of the diluent, the light fraction of diluted bitumen is comparable with that of medium and heavy crude oils and accounts for 17 to 27 percent of hydrocarbon volume.

The specific diluents used in blending are selected on the basis of many factors, including their availability in bitumen production regions. Table 3-2 shows the chemical and physical properties of the common diluent Southern Lights, a condensate produced in the United States and piped to Alberta. Because of its low viscosity, this condensate and others can be mixed with bitumen at a ratio of about 30:70 by volume.<sup>23</sup> Table 3-2 also shows the chemical and physical properties of a Suncor synthetic crude oil. Because it has a higher density than condensate, this and other synthetic crude oils are usually blended in even (50:50) ratios with bitumen. Illustrative blending ratios and resulting density and viscosity values for synbit and dilbit are given in Table 3-3.

**TABLE 3-2 Selected Properties of Two Common Diluents**

Property	Southern Lights Condensate Diluent	Suncor Synthetic Crude Oil Diluent
Density (kg/m <sup>3</sup> )	675	861
API gravity (°)	78	33
Sulfur (weight percent)	0.03	0.17
Viscosity at 20°C (68°F) (cSt)	<0.5	6.3
Sediment (parts per million by weight)	16	0

SOURCE: Data obtained from CrudeMonitor.com by Crude Quality, Inc. (<http://www.crudemonitor.ca/condensate.php?acr=SLD>; <http://www.crudemonitor.ca/crude.php?acr=SYN>) and from Enbridge website (<http://www.enbridge.com/DeliveringEnergy/Shippers/~media/www/Site%20Documents/Delivering%20Energy/2012CrudeCharacteristics.ashx>). Both accessed March 1, 2013.

**TABLE 3-3 Example Blending Ratios and Density and Viscosity Levels for Synbit and Dilbit**

Blend Component	Volume Percent	Density (kg/m <sup>3</sup> )	Viscosity [cSt at 15°C (59°F)]
<b>Synbit</b>			
Bitumen	51.7	1,010	760,000
Synthetic crude oil	48.3	865	5.9
Total	100	940	128
<b>Dilbit</b>			
Bitumen	74.6	1,010	760,000
Condensate	25.4	720	0.6
Total	100	936	350

SOURCE: Illustrative blending ratios provided by R. Segato, Suncor Energy, October 23, 2012 (<http://onlinepubs.trb.org/onlinepubs/dilbit/Segato102312.pdf>).

<sup>23</sup> These blending ratios are nominal and will vary somewhat depending on seasonal temperatures and the flow regime of individual pipeline operators.

Once they are diluted for transportation, shipments of bitumen have physical properties comparable with those of other heavy crude oil shipments, and they can be stored and transported through the same pipeline facilities in a similar manner—that is, without a need to heat the crude oil to increase fluidity. API gravities for dilbit and synbit blends are generally in the low 20 degrees (a density of about 925 kg/m<sup>3</sup>), and viscosities generally range between 75 and 200 cSt at pipeline operating temperatures.

Table 3-4 shows average density, API gravity, and viscosity values for six common diluted bitumen blends. The values are compared with those of six other heavy Canadian crude oils that are commonly piped to the United States. In some cases, these other heavy crude oils are also blended with lighter oils. As would be expected of commercial crude oils, the 12 sampled products have viscosities that conform to requisite pipeline tariff specifications.

According to API, shipments of diluted bitumen enter transmission pipelines at the same temperatures as other Canadian crude oils, generally in the range of 4°C to 25°C (40°F to 75°F) (API 2013). Temperatures will increase as a result of friction as the crude oil flows through the pipeline and because of high ambient temperatures during summer months. Because more pumping energy is needed for viscous crude oils, the temperature will be elevated in pipeline segments downstream from pumps. The temperature gain from pumping, however, will be the same for diluted bitumen as for other crude oils with similar densities and viscosities. Increasing pumping energy to boost the flow rate will raise the temperature further, but this effect will remain the same for all crude oils with corresponding levels of density and viscosity. Within the constraints of the design and safety factors of a pipeline, an operator may elect to increase the flow rate of any crude oil type as a means of adding throughput capacity, but this is strictly an economic decision.

**TABLE 3-4 Comparison of Density, API Gravity, and Viscosity of Diluted Bitumen and Other Canadian Crude Oils**

Canadian Heavy Crude Oils						
	Bow River	Fosterton	Lloydminster Blend	Lloydminster Kerrobert	Smiley–Coleville	Western Canadian Blend
Density (kg/m <sup>3</sup> )	914	927	927	930	932	929
API gravity (°)	23	21	21	20	20	21
Viscosity at 20°C (68°F) (cSt)	100	96	145	146	144	145
Viscosity at 40°C (104°F) (cSt)	37	36	52	52	51	52
Diluted Bitumen						
	Access Western	Cold Lake	Peace River Heavy	Christina Lake	Wabasca Heavy	Surmount Heavy (Synbit)
Density (kg/m <sup>3</sup> )	926	928	931	923	935	936
API gravity (°)	21	21	20	22	20	19
Viscosity at 20°C (68°F) (cSt)	150	153	113	178	134	131
Viscosity at 40°C (104°F) (cSt)	53	54	44	62	49	47

SOURCE: Data obtained from CrudeMonitor.com by Crude Quality, Inc. (<http://www.crudemonitor.ca/tools/comp/crudecomparisons.php#results>) and from Enbridge website (<http://www.enbridge.com/DeliveringEnergy/Shippers~/media/www/Site%20Documents/Delivering%20Energy/2012CrudeCharacteristics.ashx>). Both websites accessed March 1, 2013.

*Water and Sediment Content*

Refiners dislike crude oil feed containing excess water and sediment that requires filtration and added treatment for effluent disposal. Furthermore, they do not want to pay for the transportation of these impurities in crude oil shipments. Water and sediment are also undesirable from the standpoint of pipeline operators because of the potential for internal corrosion, as discussed in Chapter 5. Canadian pipeline tariffs specify that basic sediment and water (BS&W) in crude oil shipments not exceed 0.5 percent by volume. While U.S. tariffs tend to allow higher BS&W limits (1 percent in most cases), the lower Canadian threshold becomes the constraining factor for diluted bitumen and other crude oils piped into the United States from Canada.

Data specifically on the water content of pipeline shipments are difficult to obtain (as distinguished from data on combined water and sediment volumes). Nevertheless, because the Canadian tariffs are generally more restrictive than those in the United States, it can be inferred that shipments of Canadian crude oils, including diluted bitumen, do not contain more water than other crude oils transported in U.S. transmission pipelines. In the case of sediment, any amounts measured in diluted bitumen are likely to derive from the bitumen, since the diluents are largely free of sediment (as shown in Table 3-2). Some sediment sampling data are available to compare diluted bitumen with other Canadian crude oils. Figure 3-7 shows the average sediment levels for

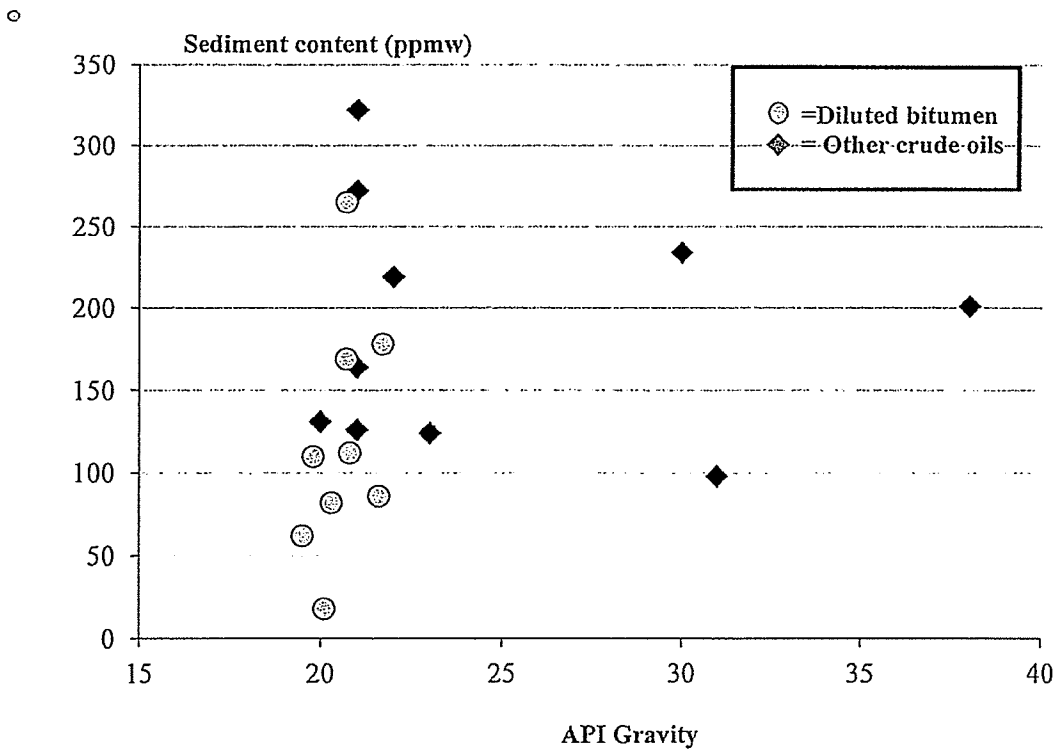

**FIGURE 3-7** Average sediment content for nine diluted bitumen blends and 10 light, medium, and heavy Canadian crude oils. [Data obtained from CrudeMonitor.com by Crude Quality, Inc. (<http://www.crudemonitor.ca/condensate.php?acr=SLD>); <http://www.crudemonitor.ca/crude.php?acr=SYN>). Accessed March 1, 2013.]

nine diluted bitumen blends and 10 light, medium, and heavy Canadian crude oils. Average sediment levels range from 18 to 265 parts per million by weight (ppmw) for the diluted bitumen and from 98 to 322 ppmw for the selection of Canadian crude oils.<sup>24</sup> Sediment quantities in this general range (<500 ppmw) will constitute less than 0.05 percent of the crude oil stream. The comparisons suggest that shipments of diluted bitumen contain sediment levels that are within the range of other crude oils piped into the United States.

Other characteristics of entrained sediments, such as the size, shape, mass, and hardness of solid particles, are seldom measured in pipeline shipments or reported in standard crude oil assays. Particle size is a potentially important factor in the tendency of sediments to clog pumps and other pipeline equipment and settle to the pipe bottom to form sludge. The shape, mass, and hardness of solid particles in sediment can also affect the potential for internal erosion.

While data on physical properties are limited, some values for particle size and other properties have been reported in laboratory studies of diluted bitumen and other crude oils. Figure 3-8 shows the particle size distribution of solids in diluted bitumen as measured by McIntyre et al. (2012). Median particle size was 0.1 micron ( $\mu\text{m}$ ) and rarely exceeded 1  $\mu\text{m}$ . Other data indicate that the distribution of particle size observed by McIntyre et al. (2012) is well within the range of other crude oils shipped by pipeline. The Canadian Crude Quality Technical Association (CCQTA) has spot sampled the desalter effluent from three refineries in Canada and the United States. The effluent was derived from crude oils other than diluted bitumen. The

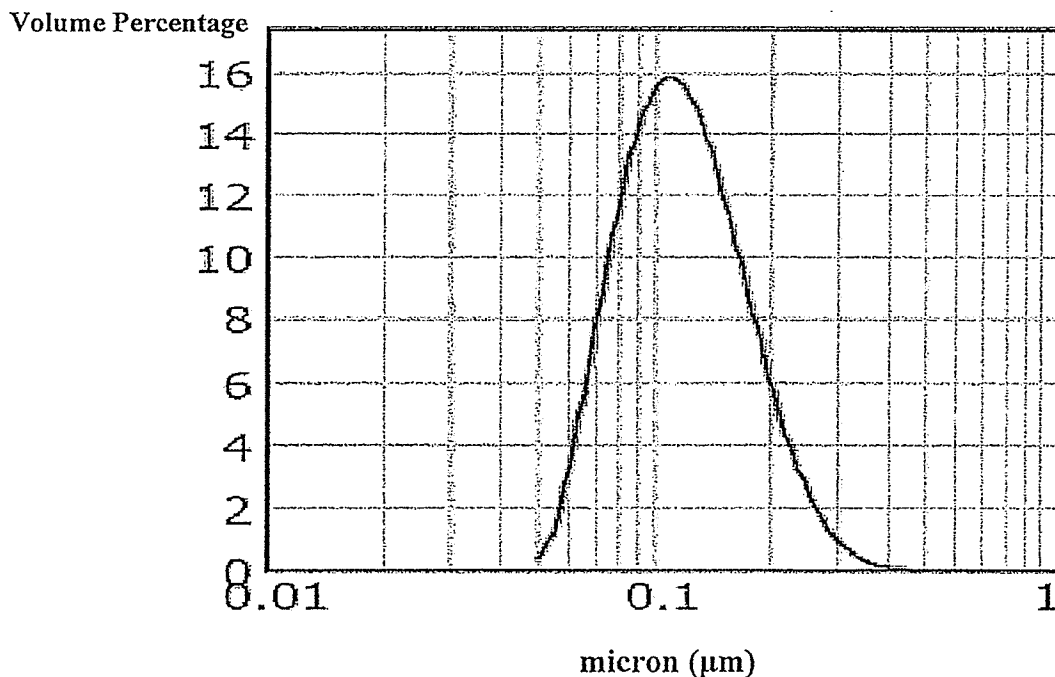

FIGURE 3-8 Particle size distribution of solids in diluted bitumen. (Source: McIntyre et al. 2012.)

<sup>24</sup> Most contaminants are expressed as parts per million (ppm), which is 1 milligram per kilogram for weight (noted as 1 ppmw) or 1 milligram per liter for volume (noted as 1 ppmv). 1,000 ppmw = 0.1 percent of weight.

particle size distributions from these samples are shown in Table 3-5. The median particle sizes for the samples ranged from about 0.4 to 1.6  $\mu\text{m}$ , higher than the median particle size reported for the diluted bitumen sampled by McIntyre et al. (2012).

CCQTA data on the nature of solids filtered from five diluted bitumen and two heavy crude oil samples show median particle sizes that are comparable across the samples, ranging from 1.0 to 2.4 microns for four of the five diluted bitumen samples and from 1.9 to 2.3 microns for the two heavy crude oil samples.<sup>25</sup> The fifth diluted bitumen sample had a median particle size of 5.6 microns. The maximum particle sizes in the five diluted bitumen samples ranged from 11 to 92 microns, while the maximum value for the two heavy crude oils was 33 microns. Data are more limited for characterizing the shape, mass, and hardness of solids in diluted bitumen and other crude oils. As noted earlier, the sand grains in unprocessed bitumen contain hard silicate minerals such as quartz, feldspar, and mica, in addition to the softer minerals found in clay fines (Strausz and Lown 2003, 31–32). However, the in situ-produced bitumen that is processed and diluted for pipeline transportation does not contain the same high levels of sand, clay fines, and other sediments found in bitumen in its native state. McIntyre et al. (2012) reported that about 1 percent of the solids in sampled diluted bitumen consisted of quartz, while clay materials (16 percent) and hydrocarbon and coke-like materials (83 percent) accounted for the remainder. X-ray diffraction analysis of the solids in the five diluted bitumen and two heavy oil samples taken by CCQTA indicate that silicate particles are more abundant in the solids of diluted bitumen (accounting for 13 to 45 percent of crystalline solids) than in the solids of other heavy crude oils sampled (accounting for 5 to 8 percent of crystalline solids).<sup>26</sup> However, the five diluted bitumen samples did not contain high levels of sediment, with none exceeding 350 ppmw (0.035 percent).

**TABLE 3-5 Size Distribution of Solid Particles Obtained from Refinery Effluent for Crude Oils Other Than Diluted Bitumen**

Particle Size ( $\mu\text{m}$ )	Refinery A					Refinery B			Refinery C
	Sample 1	Sample 2	Sample 3	Sample 4	Sample 5	Sample 1	Sample 2	Sample 3	Sample 1
Mean	0.85	1.1	1.13	0.74	1.14	2.67	1.23	0.82	0.98
Mode	0.32	0.31	0.28	0.33	0.39	2.33	0.26	0.53	0.54
Median	0.66	0.86	0.76	0.49	0.81	1.61	0.8	0.43	0.84
Minimum	0.13	0.17	0.13	0.06	0.13	0.06	0.1	0.07	0.15
Maximum	3.38	4.5	9.74	4.0	6.55	21.59	13.3	17.7	4.64
Standard deviation	0.55	0.76	1.05	0.67	0.9	3.09	1.3	1.36	0.6

SOURCE: Data provided by CCQTA and derived from Oil Sands Bitumen Processability Project. Presented to the committee on October 23, 2012 (<http://onlinepubs.trb.org/onlinepubs/dilbit/SegatoLimieux102312.pdf>).

<sup>25</sup> Data obtained from the CCQTA Oil Sands Bitumen Processability Project. Presented to the committee on October 23, 2012 (<http://onlinepubs.trb.org/onlinepubs/dilbit/SegatoLimieux102312.pdf>).

<sup>26</sup> Data obtained from the CCQTA Oil Sands Bitumen Processability Project. Presented to the committee on October 23, 2012 (<http://onlinepubs.trb.org/onlinepubs/dilbit/SegatoLimieux102312.pdf>). According to the CCQTA representative presenting the data, X-ray diffraction analysis does not measure the noncrystalline solids, which can account for 30 percent or more of the solids of sediment.

### Other Properties

Pipeline tariffs in Canada and the United States generally do not contain specifications for shipment properties apart from those discussed above, although crude oil producers and refiners may have private agreements that specify qualities such as acidity and sulfur content. Table 3-6 shows the acidity and sulfur content for several sampled Canadian heavy crude oils and diluted bitumen blends.

The acidity of crude oil is generally referenced by using total acid number (TAN), a measure of the amount (in milligrams) of potassium hydroxide (KOH) needed to neutralize the acid in a gram of oil. TAN usually increases with the extent of oil biodegradation and generally is in the range of 0.5 to 3.0 for heavy oils (Strausz and Lown 2003, 430). Although it overlaps with the range of TANs found in heavy Canadian crude oils (as shown in Table 3-6), the range of acid content in diluted bitumen blends is generally higher than the range in other crude oils because of the greater biodegradation of the natural bitumen and resulting concentrations of high-molecular-weight organic acids.

The type of acid in diluted bitumen is more important to pipeline operators than total acid content. High-molecular-weight organic acids, such as naphthenic acids, are stable in the

**TABLE 3-6 Sulfur and Total Acid Content in Sampled Canadian Heavy Crude Oils and Diluted Bitumen Blends**

	Total Sulfur (percentage by weight)	TAN (mg KOH/g oil)
<b>Canadian Heavy Crude Oils</b>		
Posterton	3.26	0.2
Lloydminster Blend	3.56	0.82
Lloydminster Kerrobert	3.12	0.92
Western Canadian Select	3.51	0.94
<b>Diluted Bitumen Blends</b>		
Albian Heavy Synthetic	2.5	0.57
Access Western Blend	3.93	1.72
Black Rock Seal Heavy	4.32	1.72
Cold Lake	3.75	0.99
Christina Lake	3.79	1.53
Peace River Heavy	5.02	2.5
Smiley–Coleville Heavy	2.97	0.98
Statoil Cheecham Blend	3.69	1.77
Surmount Heavy Blend Synbit	3.02	1.38
Western Canadian Blend	3.1	0.82

SOURCE: TAN data obtained from CrudeMonitor.com by Crude Quality, Inc.

(<http://www.crudemonitor.ca/condensate.php?acr=SLD>; <http://www.crudemonitor.ca/crude.php?acr=SYN>). Sulfur data obtained from Enbridge

(<http://www.enbridge.com/DeliveringEnergy/Shippers/~media/www/Site%20Documents/Delivering%20Energy/2012CrudeCharacteristics.ashx>). Accessed March 1, 2013.

pipeline transportation environment. These acids have boiling points higher than water and do not react at pipeline operating temperatures. Although the organic acids can be corrosive to metals used in refineries processing crude oils at temperatures above 300°C (570°F), they are not corrosive to steels at pipeline temperatures (Nesic et al. 2012). This distinction is discussed further in Chapter 5.

The Canadian heavy crude oils and diluted bitumen contain 2.5 to 5 percent sulfur by weight. Whereas condensate and synthetic crude oils are largely free of sulfur (as shown in Table 3-2), natural bitumen contains 4 to 6 percent sulfur. As described earlier, most of the sulfur in bitumen is bound in stable hydrocarbon structures. Sulfur levels in the 2.5 to 5 percent range, as found in processed bitumen diluted for transportation, are high for light- and medium-density crude oils but not unusual for heavy crude oils. While high sulfur content in crude oil is generally undesirable for refining, it is problematic for transmission pipelines mainly if it exists in surface-active compounds and hydrogen sulfide (H<sub>2</sub>S). H<sub>2</sub>S is a weak acid that is corrosive to pipelines for reasons explained in Chapter 5. Available test data on the H<sub>2</sub>S content in crude oil indicate lower levels in diluted bitumen (less than 25 ppmw in liquid phase) than in other crude oils of various densities (Figure 3-9).

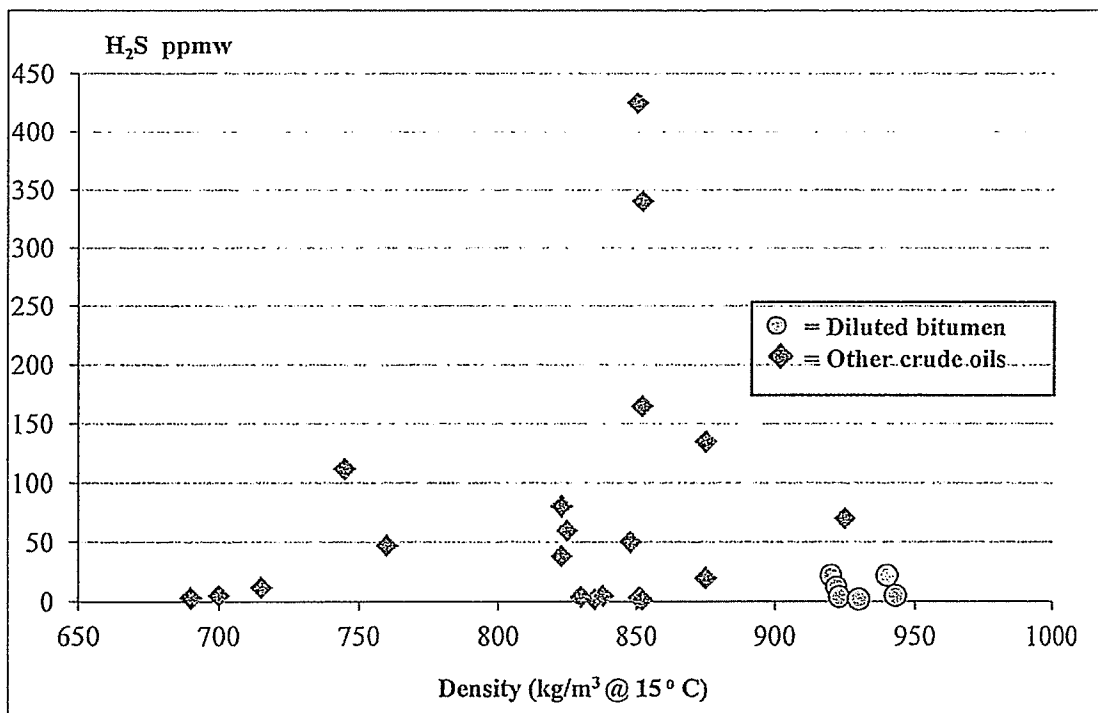

FIGURE 3-9 H<sub>2</sub>S content of diluted bitumen and other crude oils. (H<sub>2</sub>S is measured in liquid phase by using ASTM Test Method 5263. H<sub>2</sub>S remains in a liquid state in pipelines because the partial pressures of operating pipelines are below the bubble point.) (Data submitted to the committee on November 13, 2012, by the Pipeline Sour Service Project Group of CCQTA.)

### Shipment Properties and Operating Parameters Reported by Operators

For additional data on the transport properties of diluted bitumen, the committee prepared a questionnaire for the Canadian Energy Pipeline Association (CEPA). CEPA distributed the questionnaire to member companies that regularly transport diluted bitumen by transmission pipeline. The questionnaire and responses from five Canadian operators are provided in Appendix A. A summary of the operator responses on the properties of diluted bitumen is provided in Table 3-7. All of the reported values for BS&W, H<sub>2</sub>S, sulfur, density, TAN, and operating temperature are within the ranges provided in the preceding tables and figures.

With respect to the pipeline flow regime, the surveyed pipeline operators reported average flow velocities of 0.75 to 2.5 meters per second (2.5 to 6.7 feet per second) in transmission pipelines that mostly range in diameter from 20 to 42 inches but that include some mileage consisting of pipe having smaller (8 inches) and larger (up to 48 inches) diameters. Without knowledge of the pipe diameter associated with each reported flow velocity, the resulting flow cannot be verified as turbulent. In general, flow velocities ranging between 0.75 and 2.5 meters per second would be expected to maintain turbulent flow in pipelines ranging from 8 to 48 inches in diameter when they transport crude oils with the range of viscosities (113 to 153 cSt at 20°C) reported for the diluted bitumen and other heavy crude oils shown in Table 3-4.

The committee asked pipeline operators for information on the content of oxygen and carbon dioxide in shipments because these dissolved gases can be an important factor in the corrosion of pipe steel, for reasons explained in Chapter 5. Pipeline operators do not routinely measure oxygen and carbon dioxide concentrations in crude oil shipments because of the difficulty associated with sampling and detecting these gases. Nevertheless, the operators reported that because diluted bitumen and other crude oils enter the pipeline system deaerated, there should be no significant difference in the concentrations of oxygen and carbon dioxide gas in products transported in the same pipelines. Operators also reported that as a general matter they aggressively seek to limit avenues for air entry into the pipeline at all times, including periods of storage and blending and pumping operations.

**TABLE 3-7 Properties and Operating Parameters of Diluted Bitumen Shipments Reported by Five Canadian Pipeline Operators**

Property or Parameter	Unit	Range of Reported Averages	Lowest and Highest Values in Reported Normal Ranges	Highest Reported Extremes
BS&W	Volume percent	0.18 to 0.35	0.05 to 0.40	0.50
H <sub>2</sub> S	ppmw	<0.50 to 6.77	<0.50 to 11.0	11.0
Sulfur	Weight percent	3.10 to 4.00	2.45 to 4.97	5.20
Density	API gravity	19.8 to 22.1	19.0 to 23.3	23.3
TAN	mg KOH/g	1.00 to 1.30	0.85 to 2.49	3.75
Operating temperature	°C (°F)	10 to 27 (50 to 81)	4 to 43 (39 to 109)	50 (122)
Flow rate	feet/second	2.5 to 6.7	0.5 to 8.2	8.2
Pressure	psi	430 to 930	43.5 to 1,440	1,440

NOTE: Operators reported that oxygen and carbon dioxide concentrations are not routinely measured in shipments of crude oil. See Appendix A for complete survey results.



## SUMMARY

The bitumen imported into the United States is produced from Canadian oil sands. The bitumen is both mined or recovered in situ by using thermally assisted techniques. Because a large share of the bitumen deposits is too deep for mining, in situ recovery accounts for an increasing percentage of production. Because mined bitumen does not generally have qualities suitable for pipeline transportation and refinery feed, it is processed in Canada into synthetic crude oil. Bitumen recovered through use of thermally assisted methods has water and sediment content that is sufficiently low for long-distance pipeline transportation. The bitumen imported for refinery feed in the United States is recovered through in situ methods rather than mining.

Like all forms of petroleum, Canadian bitumen is a by-product of decomposed organic materials and thus a mixture of many hydrocarbons. The bitumen contains a large concentration of asphaltenes and other complex hydrocarbons that give bitumen its high density and viscosity. At ambient temperatures, bitumen does not flow and must be diluted for transportation by unheated pipelines. The diluents consist of light oils, including natural gas condensate and light synthetic crude oils. Although the diluents consist of low-molecular-weight hydrocarbons, diluted bitumen does not contain a higher percentage of these light hydrocarbons than do other crude oils. The dilution process yields a stable and fully mixed product for shipping by pipeline with density and viscosity levels in the range of other crude oils transported by pipeline in the United States.

Shipments of diluted bitumen are transported at operating temperatures, flow rates, and pressure settings typical of crude oils with similar density and viscosity. Water and sediment content conforms to the Canadian tariff limits, which are more restrictive than those in U.S. pipeline tariffs. Solids in the sediment of diluted bitumen are comparable in quantity and size with solids in other crude oils transported by pipeline. While the sulfur in diluted bitumen is at the high end of the range for crude oils, it is bound in stable hydrocarbon compounds and is not a source of corrosive hydrogen sulfide. Diluted bitumen has higher total acid content than many other crude oils because of relatively high concentrations of high-molecular-weight organic acids that are not reactive at pipeline temperatures.

## REFERENCES

### Abbreviations

API	American Petroleum Institute
CAPP	Canadian Association of Petroleum Producers
ERCB	Energy Resources Conservation Board
NEB	National Energy Board
USGS	U.S. Geological Survey
WEC	World Energy Council

- API. 2013. Diluted Bitumen. March 20. <http://www.api.org/~media/Files/Oil-and-Natural-> CAPP. 2013. *Technical Bulletin: Alberta Oil Sands Bitumen Valuation Methodology*. Report 2013-9995 (updated monthly). Calgary, Alberta, Canada. <http://www.capp.ca>.
- Cimino, R., S. Corraera, A. del Bianco, and T. P. Lockhart. 1995. Solubility and Phase Behavior of Asphaltenes in Hydrocarbon Media. In *Asphaltenes: Fundamentals and Applications* (E. Y. Sheu and O. C. Mullins, eds.), Plenum Press, New York, pp. 97–130.

- Dettman, H. D. 2012. Characteristics of Oil Sands Products. Presentation to Center for Spills in the Environment, Oil Sands Products Training, Portland, Maine, Dec. 4–5.
- ERCB. 2012a. *Alberta's Energy Reserves 2011 and Supply/Demand Outlook*. Report ST98-2012. Calgary, Alberta, Canada.
- ERCB. 2012b. In-Situ Process: Steam-Assisted Gravity Drainage. Calgary, Alberta, Canada.
- ERCB. 2013. Upgrading and Refining. Calgary, Alberta, Canada, March 31.
- Gogoi, B. K., and R. L. Bezbaruah. 2002. Microbial Degradation of Sulfur Compounds Present in Coal and Petroleum. In *Biotransformations: Bioremediation Technology for Health and Environmental Protection* (R. D. Stapleton and V. P. Singh, eds.), Elsevier, pp. 427–456.
- Leontaritis, K., and G. Mansoori. 1988. Asphaltene Deposition: A Survey of Field Experiences and Research Approaches. *Journal of Petroleum Science and Engineering*, Vol. 1, No. 3, pp. 229–239.
- Maqbool, T., A. T. Balgoa, and H. S. Fogler. 2009. Revisiting Asphaltene Precipitation from Crude Oils: A Case of Neglected Kinetic Effects. *Energy and Fuels*, Vol. 23, pp. 3681–3686.
- McIntyre, D. R., M. Achour, M. E. Scribner, and P. K. Zimmerman. 2012. Laboratory Tests Comparing the Corrosivity of Dilbit and Synbit with Conventional Crudes Under Pipeline Conditions. Paper 2012-05. *Proc., 2012 Northern Area Eastern Conference: Corrosivity of Crude Oil Under Pipeline Operating Conditions*, National Association of Corrosion Engineers International, Houston, Tex.
- NEB. 2009. *Canada's Energy Future: Infrastructure Changes and Challenges to 2020*. Calgary, Alberta, Canada.
- Nesic, S., S. Richter, W. Robbins, F. Ayello, P. Ajmera, and S. Yang. 2012. Crude Oil Chemistry on Inhibition of Corrosion and Phase Wetting. Paper 2012-16(c). *Proc., 2012 Northern Area Eastern Conference: Corrosivity of Crude Oil Under Pipeline Operating Conditions*, National Association of Corrosion Engineers International, Houston, Tex.
- Rahimi, P. M., R. E. Ellenwood, R. J. Parker, J. M. Kan, N. Andersen, and T. Dabros. 1998. Partial Upgrading of Athabasca Bitumen Froth by Asphaltene Removal. Paper 1998.074. *Proc., 7th UNITAR International Conference for Heavy Crude and Tar Sands*, Beijing, Oct. 27–30. <http://www.oildrop.org/Lib/Conf/7thtoc.html>.
- Rahimi, P. M., and T. Gentzis. 2006. The Chemistry of Bitumen and Heavy Oil Processing. In *Practical Advances in Petroleum Processing* (C. S. Hsu and P. R. Robinson, eds.), Springer, pp. 148–186.
- Raicar, J., and R. M. Procter. 1984. Economic Considerations and Potential of Heavy Oil Supply from Lloydminster—Alberta, Canada. In *Second UNITAR International Conference on Heavy Crude and Tar Sands* (R. F. Meyer, J. C. Wynn, and J. C. Olson, eds.), McGraw-Hill, New York, pp. 212–219.
- Saniere, A., I. Hénaut, and J. Argiller. 2004. Pipeline Transportation of Heavy Oils: A Strategic, Economic and Technological Challenge. *Oil and Gas Science and Technology—Revue d'IFP Energies nouvelles*, Vol. 59, No. 5, pp. 455–466.
- Schermer, W. E. M., P. M. J. Melein, and F. G. A. van den Berg. 2004. Simple Techniques for Evaluation of Crude Oil Compatibility. *Petroleum Science and Technology*, Vol. 22, Nos. 7–8, pp. 1045–1054.
- Strausz, O. P., and E. M. Lown. 2003. *The Chemistry of Alberta Oil Sands, Bitumen, and Heavy Oils*. Alberta Energy Research Institute, Calgary, Canada.
- Strausz, O. P., E. M. Lown, A. Morales-Izquierdo, N. Kazmi, D. S. Montgomery, J. D. Payzant, and J. Murgich. 2011. Chemical Composition of Athabasca Bitumen: The Distillable Aromatic Fraction. *Energy and Fuels*, Vol. 25, No. 10, pp. 4552–4579.
- USGS. 2006. National Assessment of Oil and Gas Fact Sheet: Natural Bitumen Resources of the United States. Fact Sheet 2006-3133. U.S. Department of the Interior, Nov.
- WEC. 2010. *2010 Survey of Energy Resources*. London. [http://www.worldenergy.org/documents/ser\\_2010\\_report\\_1.pdf](http://www.worldenergy.org/documents/ser_2010_report_1.pdf).

## Review of Pipeline Incident Data

This chapter reviews U.S. and Canadian pipeline incident statistics and investigations for insight into whether transmission pipelines experience more releases when they transport diluted bitumen than when they transport other crude oils.

### U.S. AND CANADIAN INCIDENT DATA

The Pipeline and Hazardous Materials Safety Administration (PHMSA) requires that all regulated pipeline operators report unintended releases that meet certain thresholds of release quantities or impact severity. PHMSA tracks and analyzes these reports to inform its inspection, investigation, and enforcement activities.<sup>1</sup> PHMSA inspectors also conduct more in-depth investigations of selected incidents. Incidents involving especially severe consequences, such as deaths, injuries, evacuations, and environmental damage, may also be investigated by the National Transportation Safety Board (NTSB). Through field and forensic investigations, NTSB assesses both causal and contributing factors and recommends preventive and follow-up actions, including regulatory responses.<sup>2</sup> The National Energy Board (NEB) and Transportation Safety Board (TSB) serve similar functions, respectively, for incidents involving pipelines in Canada. PHMSA and NEB incident statistics and investigations, as well as relevant investigations by NTSB and TSB, are reviewed next.

### PHMSA Incident Data and Investigations

PHMSA regulations require that operators of hazardous liquid pipelines, which include crude oil pipelines, report any incident that involves a release of 5 gallons or more or explosion, fire, serious injury, or significant property damage.<sup>3</sup> Incidents that involve any component of the pipeline facility, including line pipe, tanks, valves, manifolds, and pumps, must be reported. A short reporting form is required for notifying the agency of small releases, and a longer form is required for larger releases and any release into water exceeding 5 gallons. Before 2002 the threshold for reporting releases was 50 barrels. The reporting changes make comparisons of recent release data with historical performance difficult. A further complication of the reporting system is that while PHMSA reporting covers most crude oil pipelines, there are exceptions to coverage, such as some intrastate pipelines and gathering systems.

The number of incidents reported for regulated crude oil pipelines during 2002 to 2011 is shown in Figure 4-1. During the 10-year period, the number of large incidents fluctuated from about 80 to 120 per year. Total releases trended downward from about 190 to 150 per year, with small releases accounting for between one-third and one-half of the total. System components involved in the releases are shown in Figure 4-2. Main-line pipe and tanks were involved in

---

<sup>1</sup> More discussion of PHMSA safety oversight programs can be found in Appendix B.

<sup>2</sup> NTSB recommendations pertaining to PHMSA's pipeline safety authorities can be found at <http://www.phmsa.dot.gov/pipeline/rcgs/ntsb>.

<sup>3</sup> 49 CFR 195.50.

about one-third of the incidents, while all other equipment, such as pumps, valves, and fittings, accounted for the rest. A generalization that can be made is that the larger releases tend to be associated with main-line pipe, and sometimes with tanks, whereas the other system components tend to experience smaller releases on average. For 2002 to 2012, the pattern of releases by system component and cause is shown in Figure 4-3 and Table 4-1. The causal distribution differed by component. For main-line pipe, internal corrosion was the cause of about one-third of releases, while external corrosion and outside force damage accounted for most of the remainder. For most other pipeline components, incorrect operation and malfunctioning equipment were the main causes of incidents. Most of the corrosion-related incidents reported to PHMSA occurred in pipes and pumps. Main-line pipe was the dominant location for external corrosion. Whereas main-line pipe also accounted for about one-third of incidents involving internal corrosion, more of these incidents occurred in pumps.

Each year, PHMSA inspectors select as many as two dozen pipeline incidents for more thorough investigation on the basis of the severity of the consequences, the nature of the suspected failure modes, and the incident and compliance history of the pipeline system involved. The investigations normally consist of site visits, forensic tests, interviews with operating personnel, and reviews of operator records. Since 2005, PHMSA has conducted 63 investigations of natural gas and hazardous liquid pipelines, including 14 incidents involving onshore crude oil transmission pipelines.<sup>4</sup> The latter incidents are referenced in Table 4-2. In the

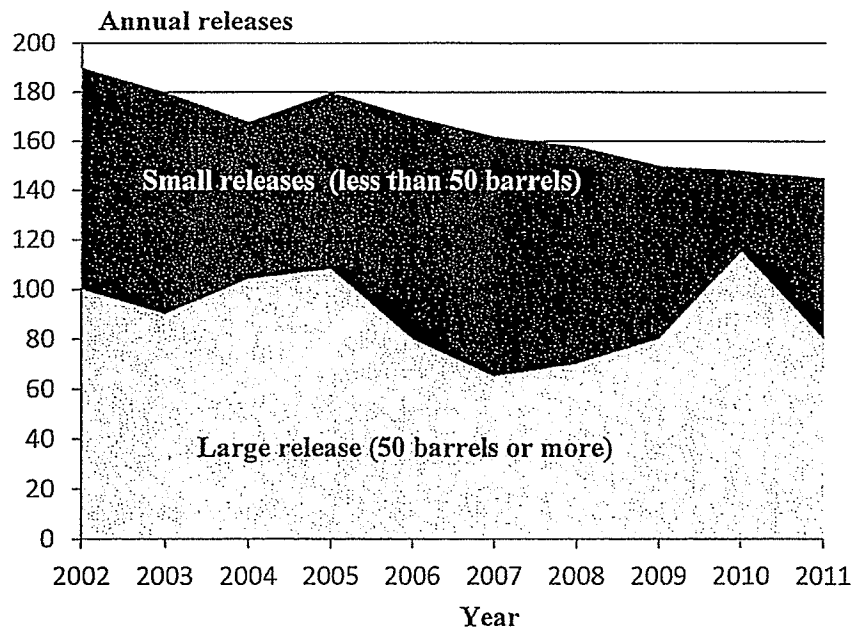

**FIGURE 4-1** Crude oil pipeline incidents reported to PHMSA, 2002 to 2011. (Incident data were provided to the committee by PHMSA during the October 23, 2012, committee meeting.)

<sup>4</sup> <http://phmsa.dot.gov/pipeline/library/failure-reports>.

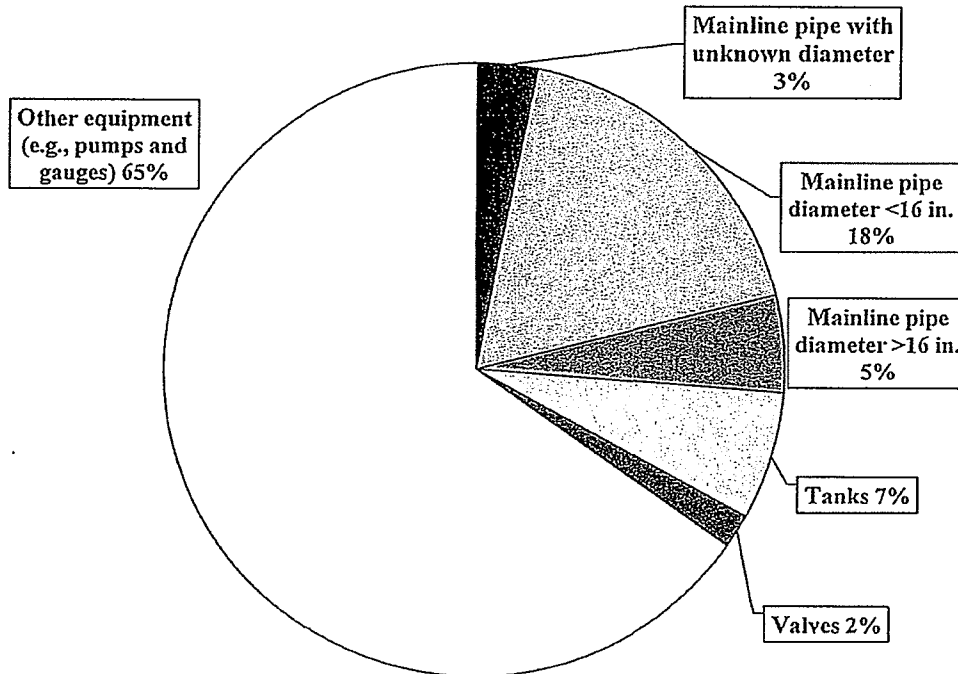

**FIGURE 4-2** Crude oil pipeline incidents reported to PHMSA by system component involved, 2002 to 2012. [Data were obtained from analysis of PHMSA data from the Environmental Impact Statement of TransCanada XL permit application (U.S. Department of State 2013, Volume IV, Appendix K).]

two cases found to have involved internal corrosion, factors other than the properties of the crude oils transported were cited as causes. In three other cases, investigators reported that internal pressure cycles and associated stress loadings may have contributed to the formation and growth of cracks initiated at sites of external corrosion.

Apart from providing some examples of possible failures related to the transported product, the PHMSA investigations do not provide evidence that pipelines transporting diluted bitumen are more susceptible to release. In the next chapter, the chemical and physical properties of diluted bitumen are examined to deduce possible susceptibilities to pipeline damage.

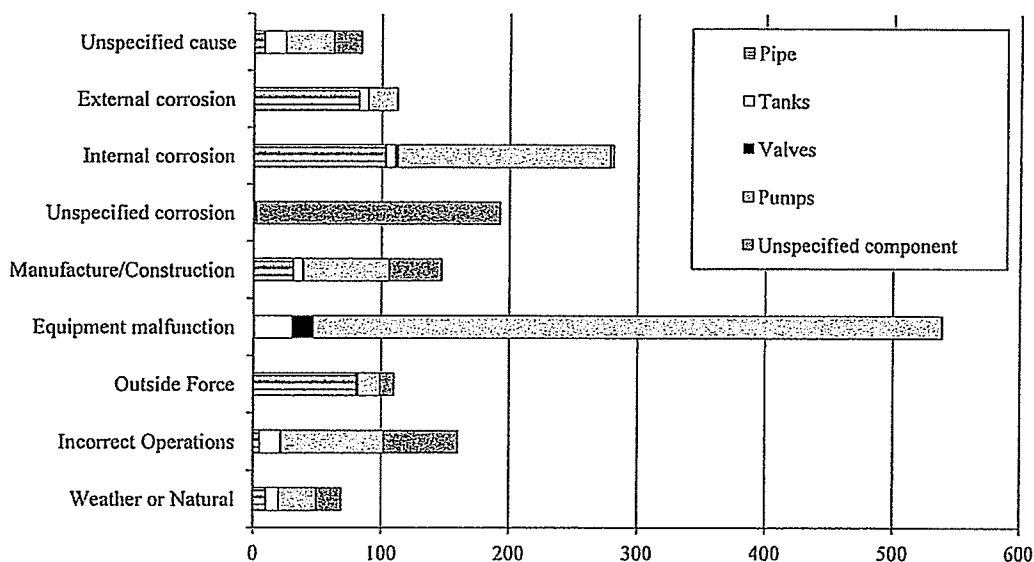

FIGURE 4-3 Crude oil pipeline incident reports to PHMSA by cause of release and system component involved, 2002 to 2012. (Source: U.S. Department of State 2013, Volume IV, Appendix K.)

TABLE 4-1 Crude Oil Pipeline Incident Reports to PHMSA by Cause of Release and System Component Involved, 2002 to 2012

Reports of Pipeline Releases to PHMSA, 2002–2012						
	Pipe	Tanks	Valves	Pumps	Unspecified Component	Total
Weather or natural force	10	10	0	29	20	69
Incorrect operations	5	16	1	80	58	160
Outside force	80	0	2	17	11	110
Equipment malfunction	1	29	17	491	1	539
Manufacture or construction	31	7	1	67	41	147
Unspecified corrosion	1	1	0	0	191	193
Internal corrosion	103	7	3	165	3	281
External corrosion	82	7	0	23	0	112
Unspecified cause	8	16	1	37	22	84
Total	321	93	25	909	347	1,695

SOURCE: U.S. Department of State 2013, Volume IV, Appendix K.

TABLE 4-2 PHMSA Crude Oil Pipeline Incident Investigations, 2005 to 2012

Date of Failure	Operator	Location	Commodity Released	System Component	Attributed Cause	Summary
4/12/05	Jayhawk Pipeline	Stevens, Kansas	Crude oil	7-in. main-line pipe section	Internal corrosion	Sand and saltwater collected in a low point in the pipeline, resulting in corrosive conditions.
1/1/07	Enbridge Energy Partners	Clark County, Wisconsin	Crude oil from Canada	24-in. main-line pipe section	Defect in manufacture	Weld seams did not fuse during pipe manufacture. The defect grew to a critical size by fatigue from operating pressure cycles.
11/13/07	Enbridge Energy Partners	Clearbrook, Minnesota	Crude oil from Canada	34-in. main-line pipe section	Defect in manufacture	Pipe was transported to the construction site on rail cars, causing fatigue cracks from cyclical loading. Pressure cycling during operations may have caused the cracks to grow to failure.
2/18/09	Mid-Valley Pipeline	Cygnets, Ohio	Crude oil	12-in. branch connection to main line	Material failure	The combined loading of the branch connection, valve, and flanging caused the branch attachment to crack at the weld.
6/9/09	Enbridge Energy Partners	Gowan, Minnesota	Crude oil from Canada	26-in. main-line pipe section	Material failure	A sleeve installed 20 years earlier to repair a pipe split opened at a deficient weld.
12/23/09	Enterprise Products	Galveston, Texas	Crude oil from offshore	Meter station component	Material failure in a fitting	Cap screws on a stainless steel pressure switch failed because of hydrogen-assisted cracking promoted by galvanic corrosion.
3/1/10	Mid-Valley Pipeline	Gregg County, Texas	Crude oil	Tank farm manifold piping	Internal corrosion	Internal corrosion occurred in a dead-leg section of pipe with no flow during normal operations.
6/11/10	Chevron Pipe Line	Salt Lake County, Utah	Crude oil	10-in. main-line pipe section	Outside force damage	An electric charge jumped from a metal fence to the pipe, creating a 0.5-in. hole in the top of the pipe.
6/14/10	Suncor Energy Pipeline	Laramie, Wyoming	Crude oil	Breakout tank	Incorrect operation	Operating personnel did not respond to an alarm indicating tank capacity had been reached.

(continued)

TABLE 4-2 (continued) PHMSA Crude Oil Pipeline Incident Investigations, 2005 to 2012

Date of Failure	Operator	Location	Commodity Released	System Component	Attributed Cause	Summary
11/16/10	Shell Pipeline	Vinton, Louisiana	Crude oil from offshore	22-in. main-line pipe section	Material failure	The coating disbonded at a bend in the pipe allowing the onset of corrosion. Cyclical loading due to normal batch operations may have contributed to crack growth.
12/1/10	Chevron Pipe Line	Salt Lake County, Utah	Crude oil (condensate)	Valve used for water injection in main line	Incorrect operation	Water was not properly drained from the valve. Internal pressure brought on by freezing water caused the valve connection to leak.
1/26/11	Chevron Pipe Line	Plaquemine s Parish, Louisiana	Crude oil from offshore	10-in. main-line pipe section at river crossing	Excavation damage	The pipeline was being lowered while in service. Stress concentrations from the procedure caused fracturing in an area with preexisting dents.
2/21/11	Enterprise Products	Cushing, Oklahoma	Crude oil	8-in. pipe within terminal area	Incorrect operation	Personnel purging a pipe failed to shut down the pump, which resulted in the delivery being pumped against a closed valve, causing a pipe with preexisting manufacturing defects to fail.
7/1/11	ExxonMobil Pipeline	Laurel, Montana	Crude oil	12-in. main-line pipe section	Outside force damage	River flooding caused debris to strike and rupture the line.

SOURCE: PHMSA's pipeline failure investigation reports can be found at <http://phmsa.dot.gov/pipeline/library/failure-reports>.

### NEB Incident Statistics

NEB regulates interprovincial pipelines in Canada. The regulated network consists of 11,000 miles of crude oil pipeline, nearly all of which are in transmission systems. Regulated operators must file an "accident" record if a pipeline facility experiences a fatal or serious injury, fire, or explosion due to a release; any other damage to the pipeline that causes a release; and any form of outside force damage, even if it does not lead to a release. In addition, operators are required to file an "incident" report in the event of an uncontrolled release, operations that exceed design limits, an abnormality that reduces structural integrity, or a shutdown for safety reasons. These reported incidents do not necessarily involve releases.



From 2004 to 2011,<sup>5</sup> NEB received 12 accident reports and 292 incident reports involving crude oil transmission pipelines (TSB 2012, Table 5). Of the 292 incidents involving pipeline integrity issues—such as internal and external degradation—cracks accounted for the largest share, almost 30 percent (see Figure 4-4). Metal loss, mainly from corrosion, was reported in 16 percent of incidents. Of the 12 accident reports, one involved combined corrosion and cracking (stress corrosion cracking), as discussed in more detail below.

### NTSB and TSB Investigations

The main transportation safety investigative bodies in the United States and Canada are NTSB and TSB, respectively. Although their pipeline investigations are thorough, they are infrequent and selective. For example, over the past decade NTSB has investigated fewer than a dozen

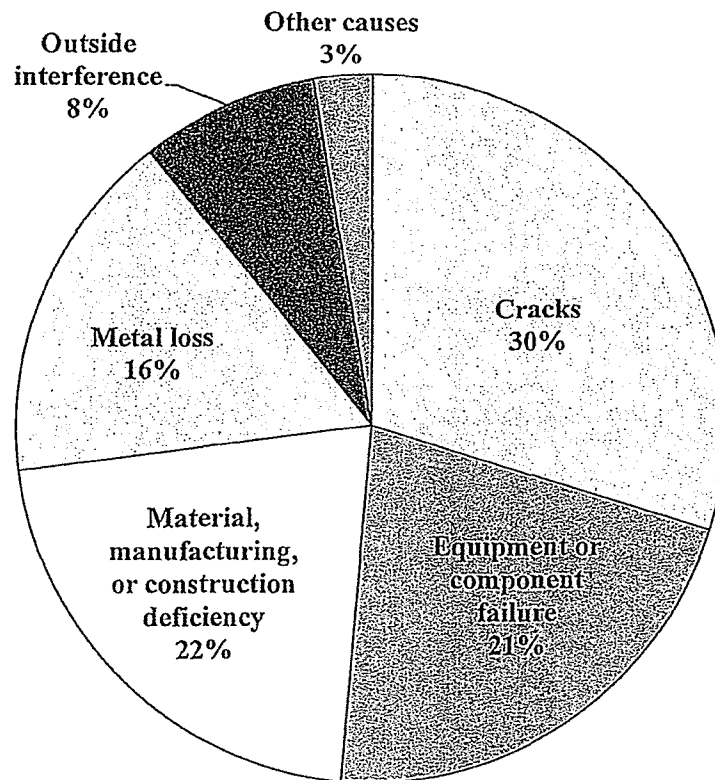

**FIGURE 4-4** Causes of crude oil transmission pipeline incidents reported to NEB, 2004 to 2011. (Source: TSB 2012, Table 5.)

<sup>5</sup> Before 2004, the definition of reportable incident used by NEB was different from that used today. The reporting change makes longer-term trend analysis less meaningful.

pipeline incidents, most involving pipelines carrying volatile commodities such as natural gas and refined products.<sup>6</sup> The investigations are helpful in understanding factors that can interact to cause pipeline damage and failures, but they produce limited information useful in assessing the effect of specific crude oil types or crude oil properties on pipeline release probabilities.

In 2012, NTSB completed an investigation of a pipeline failure in which diluted bitumen was reported to have been released. The incident involved a 30-inch transmission pipeline that ruptured and released 20,000 barrels of product into a river near Marshall, Michigan (NTSB 2012). The investigators determined that the cause of the rupture was cracks that had formed in a corrosion pit on the outside of the pipe under a disbonded polyethylene tape coating. The cracks coalesced and grew as a result of stresses on the pipe, a process known as environmentally assisted cracking (EAC), which is described in more detail in Chapter 5. The Marshall release attracted considerable attention because of the consequences of the release and the actions of the operator. However, NTSB did not report that specific properties of the products transported through the pipeline at the time of the event or in the past had caused or contributed to the pipeline damage.

As noted above, one of the 12 crude oil pipeline accidents reported to NEB since 2004 involved a corroded and cracked pipeline. This release, which occurred in 2007, was investigated by TSB.<sup>7</sup> The release was from a 34-inch transmission pipeline originating in Alberta and transporting crude oil to the United States (TSB 2007). A forensic analysis of the ruptured pipe joint detected a shallow corrosion pit at a weld on the outside of the pipe that led to a stress corrosion crack, which eventually spread and fractured the pipe. TSB investigators determined that the polyethylene tape coating had tented over the weld, shielding the pipe from the beneficial effects of the cathodic protection current.<sup>8</sup> The corrosion pit that developed because of the tape failure became a stress concentration site where cracks formed and grew. TSB noted that 2 years earlier the operator had converted the pipeline to batch operations and surmised that this operational change may have contributed to crack growth as a result of more cyclic stress loadings from internal pressure fluctuations. Whether specific varieties of crude oil in the stream had properties that contributed to more severe pressure cycling was not reported by TSB.

A review of other NTSB and TSB investigations over the past decade did not indicate any cases in which specific crude oil types or shipment properties were associated with causes of pipeline damage or failure.

### **Assessment of Information from Incident Reports**

The causes of pipeline incidents reported to PHMSA are proximate and broadly categorized. Incidents categorized as corrosion damage, for example, do not distinguish among those occurring as a result of the action of microorganisms, in combination with stress cracking, or at sites of preexisting mechanical damage. Some types of damage, such as EAC, may be categorized alternatively as caused by corrosion, a manufacturing defect, or a material failure. Whereas NTSB and TSB investigations provide detailed information on factors causing and

---

<sup>6</sup> NTSB pipeline investigation reports are available at [http://www.ntsb.gov/investigations/reports\\_pipeline.html](http://www.ntsb.gov/investigations/reports_pipeline.html).

<sup>7</sup> NEB may conduct its own investigations of a reported incident to ensure that safety regulations are being followed and to determine the need for remedial actions.

<sup>8</sup> When the tape disbonds from the pipe steel, moisture can accumulate beneath the tape surface. Because the tape has fairly high electrical insulation properties, it can prevent cathodic protection current from reaching the exposed steel subject to corrosion.

contributing to pipeline releases, the investigations are too few in number to assess the causal effects of specific crude oil types and their properties.

Because of the potentially large number of factors associated with a given release, it is often difficult to isolate the role of any single causative factor, such as the effect of the specific crude oil being transported on time-dependent mechanisms such as corrosion and cracking. Sources of pipeline damage affected by the crude oils transported, either at the time of the release or in earlier shipments, are most pertinent to this study. Neither PHMSA nor NEB incident data contain information on the types of crude oils transported or the properties of past shipments in the affected pipeline.

## STATE AND PROVINCIAL INCIDENT DATA

Some U.S. states and Canadian provinces maintain reporting systems for incidents in intrastate and intraprovincial pipeline systems, including gathering lines. The Energy Resources Conservation Board (ERCB) holds this responsibility in Alberta. In the United States, several state regulators have authority over intrastate pipelines, including the state fire marshal of California. Pipeline incident data and analyses derived from both of these jurisdictions were considered.

### Alberta ERCB Incident Data

The Alberta ERCB regulates and monitors the safe performance of oil pipelines in the province, with the exception of approximately 700 miles of NEB-regulated transmission pipeline crossing into other provinces and the United States.<sup>9</sup> ERCB mandates reporting of all pipeline incidents involving a release or damage from an outside force. In 2007, the agency reviewed the causes of 411 crude oil pipeline incidents reported from 1990 to 2005 (EUB 2007). The ERCB analysis showed that the largest single cause was internal corrosion, which the agency ascribed to the effects of the large percentage of gathering pipelines in the province. These small-diameter lines were described as susceptible to internal corrosion because of repeated low-flow conditions; frequent stopping and idling of movements; and the mixture of raw crude oil, gases, sediments, and waters carried from production fields (EUB 2007, 30). About 29 percent of the roughly 11,000 miles of ERCB-regulated pipeline mileage consisted of pipe with a diameter of 4 inches or less, and 73 percent had a diameter of 12 inches or less. Only about 1 percent of the mileage consisted of pipelines having a diameter of more than 22 inches.

Although ERCB release statistics have at times been cited as evidence of a corrosive effect of diluted bitumen on pipelines (Swift et al. 2011), the regulated systems represented by these incident statistics are not comparable with transmission pipelines in size, operations, or, most important, contents. As a result, the committee concluded that the ERCB data were not useful for the purposes of this study.

### California Pipeline Safety Study

Pipeline operators in California have a long history of transporting crude oils with physical properties similar to those of Canadian crude oils and diluted bitumen. Most of the oil from the

---

<sup>9</sup>The Energy and Utilities Board regulated pipelines in Alberta until it was replaced in 2008 by ERCB.

San Joaquin Valley, for instance, has an American Petroleum Institute (API) gravity of 18 degrees or less, with the Kern River field producing especially dense crude oil with an API gravity of about 13 degrees (Sheridan 2006). Like bitumen producers, California oil producers commonly use thermal recovery techniques, such as injecting steam through the wellbore, to reduce crude oil viscosity and facilitate pumping to the surface. Heavier California crude oils are often transported undiluted through heated pipelines. This is not the case for Canadian bitumen, which is diluted for transportation.<sup>10</sup>

California has nearly 3,300 miles of transmission pipelines subject to federal safety regulation.<sup>11</sup> In addition, the state contains 3,000 to 4,000 miles of state-regulated pipeline, most of it in gathering systems. Responsibility for regulating the safety of hazardous liquid pipelines in California is shared by PHMSA and the California State Fire Marshal (CSFM).

In 1993, CSFM issued a report of the incident history of hazardous liquid pipelines in the state from 1981 to 1990 (CSFM 1993). The report examined releases from state and federally regulated lines, including those transporting refined petroleum products. Operators were required to submit records of releases during the period regardless of release quantity or consequences, along with information on pipeline diameter, length, age, operating temperature, and external coating type. Although the report is now 20 years old, its results have been cited as indicative of the potential effects of diluted bitumen on pipeline integrity (NRDC 2011).

The CSFM study documented 502 releases from hazardous liquid pipelines in California during the 10-year period. Analyses of the incident records indicated that external corrosion was the leading cause of releases, accounting for 59 percent, followed by third-party damage (20 percent), equipment malfunctions (5 percent), and weld failures (4 percent). Internal corrosion accounted for 3 percent, while operator error accounted for 2 percent.<sup>12</sup> Crude oil pipelines generated 62 percent of total releases, including 70 percent of the releases attributed to external corrosion.

While the CSFM study did not investigate each reported incident in depth, statistical analyses of the 502 records presented some patterns of interest. The age of the pipeline was correlated with a higher release rate. For example, 62 percent of the releases occurred in pipelines constructed before 1950, even though these lines accounted for only 18 percent of pipeline mileage. CSFM noted that many of the pipelines built in California during the first half of the 20th century lacked cathodic protection for most of their service lives, which suggests that the lack of cathodic protection, coupled with the absence of coatings or use of older coating materials, may have led to the high incidence of external corrosion relative to other failure causes.<sup>13</sup> The CSFM analysis revealed that 22 percent of the external corrosion incidents occurred in pipelines that were uncoated, and another 53 percent occurred in pipelines coated or wrapped with certain materials, most often asphalt and tar.

One finding that stood out among pipelines experiencing external corrosion was the disproportionate number of small-diameter pipelines that were operating at relatively high temperatures. Operating temperature was highly correlated with external corrosion—more than half the releases from external corrosion occurred in the 21 percent of pipeline mileage in which

---

<sup>10</sup> As discussed in Chapter 2, California oil fields are served by transmission pipelines that connect to refineries elsewhere in the state. The transmission pipelines do not cross state borders.

<sup>11</sup> Pipeline mileage by state is available at the following PHMSA website:  
[http://primis.phmsa.dot.gov/comm/reports/safety/CA\\_detail1.html?nocache=9253#\\_OuterPanel\\_tab\\_5](http://primis.phmsa.dot.gov/comm/reports/safety/CA_detail1.html?nocache=9253#_OuterPanel_tab_5).

<sup>12</sup> All other causes accounted for 7 percent of releases.

<sup>13</sup> As is discussed in Chapter 5, some older coating technologies shield cathodic protection currents.

the operating temperature regularly reached or exceeded 55°C (130°F). In addition, a large portion of the pipelines experiencing external corrosion consisted of small-diameter pipe. Although they accounted for only 13 percent of pipeline mileage, pipelines with diameters of less than 8 inches accounted for 21 percent of external corrosion incidents. Larger pipelines, with diameters of 16 inches or more, accounted for 23 percent of mileage but only 6 percent of the external corrosion incidents.

The preponderance of external corrosion incidents in smaller-diameter pipe and pipelines with high operating temperatures does not indicate that transmission pipelines contributed to the high rate of pipeline releases in California during the 1980s. Instead, the results suggest that older lines, many of which lacked modern coatings and cathodic protection for much of their operating history, were the main source of the releases. The high operating temperatures of many of these pipelines can be attributed to the thermal recovery methods used for California crude oil production. While the California experience illustrates the problems that can arise when pipelines are not properly protected against external corrosion, it is not indicative of the protections afforded crude oil transmission pipelines today.<sup>14</sup>

## SUMMARY

A logical step in addressing the question of whether shipments of diluted have a greater propensity to causes pipeline releases than shipments of other crude oils is to examine historical release records. The incident statistics can be used to identify the general sources of pipeline failure. However, the information contained in the U.S. and Canadian incident records is insufficient to draw definitive conclusions. One reason is that the causal categories in the databases lack the specificity needed to assess the particular ways in which transporting diluted bitumen can affect the susceptibility of pipelines to failure. Another reason is that incident records do not contain information on the types of crude oil transported and the properties of past shipments in the affected pipeline. Because many pipeline releases involve cumulative and time-dependent damage, there is no practical way to trace the transportation history of a damaged pipeline to assess the role played by each type of crude oil and its properties in transport.

Incident reporting systems in Canada and the United States do not have uniform reporting criteria and coverage. Given the relatively small number of pipeline incidents, even minor variations in reporting criteria can lead to significant differences in incident frequencies and causal patterns. Some reporting systems combine incident reports from oil gathering and transmission systems, while others do not. Variation in reporting coverage is problematic because gathering pipelines are fundamentally different from transmission pipelines in design, maintenance, and operations and in the quality and quantity of the liquids they carry.

## REFERENCES

### Abbreviations

CSFM	California State Fire Marshal
EUB	Energy and Utilities Board
NRDC	Natural Resources Defense Council

---

<sup>14</sup> All hazardous liquid transmission pipelines are required by federal regulation to have cathodic protection.

NTSB            National Transportation Safety Board  
 TSB            Transportation Safety Board of Canada

- CSFM. 1993. *Hazardous Liquid Pipeline Risk Assessment*. Sacramento, Calif.  
<http://osfm.fire.ca.gov/pipeline/pdf/publication/pipelineriskassessment.pdf>.
- EUB. 2007. *Pipeline Performance in Alberta, 1990–2005*. Report 2007-A. Alberta, Canada, April.  
<http://www.ercb.ca/reports/r2007-A.pdf>.
- NRDC. 2011. *Say No to Tar Sands Pipeline: Proposed Keystone XL Project Would Deliver Dirty Fuel at a High Cost*. Washington, D.C., March. <http://www.nrdc.org/land/files/TarSandsPipeline4pgr.pdf>.
- NTSB. 2012. *Enbridge Incorporated Hazardous Liquid Pipeline Rupture and Release, Marshall, Michigan, July 25, 2010*. Report NTSB/PAR-12/01. Washington, D.C.  
<http://www.nts.gov/doclib/reports/2012/PAR1201.pdf>.
- Sheridan, M. 2006. *California Crude Oil Production and Imports*. Staff Paper CEC-600-2006-006. Fossil Fuels Office, Fuels and Transportation Division, California Energy Commission, April.  
<http://www.energy.ca.gov/2006publications/CEC-600-2006-006.pdf>.
- Swift, A., S. Casey-Lefkowitz, and E. Shope. 2011. *Tar Sands Pipelines Safety Risks*. Natural Resources Defense Council, National Wildlife Federation, Pipeline Safety Trust, and Sierra Club, Washington, D.C. <http://www.nrdc.org/energy/files/tarsandssafetyrisks.pdf>.
- TSB. 2007. *Pipeline Investigation Report: Crude Oil Pipeline Rupture, Enbridge Pipelines, Inc., Line 3, Mile Post 506.2217, near Glenavon, Saskatchewan, 15 April 2007*. Report P07H0014. <http://www.bst-tsb.gc.ca/eng/rappports-reports/pipeline/2007/p07h0014/p07h0014.pdf>.
- TSB. 2012. *Statistical Summary, Pipeline Occurrences 2011*. Gatineau, Quebec, Canada.  
<http://www.tsb.gc.ca/eng/stats/pipeline/2011/ss11.pdf>.
- U.S. Department of State. 2013. *Draft Supplementary Environmental Impact Statement for the Keystone XL Project Applicant for Presidential Permit: TransCanada Keystone Pipeline, LP*. Bureau of Oceans and International Environmental and Scientific Affairs, Washington, D.C.  
<http://keystonepipeline-xl.state.gov/draftseis/index.htm>.

## Assessing the Effects of Diluted Bitumen on Pipelines

This chapter examines the main causes of pipeline failure and the physical and chemical properties of the transported crude oils that can affect each. The relevant properties of diluted bitumen and other crude oil shipments are compared to make judgments about whether transporting diluted bitumen increases the likelihood that a pipeline will fail. Consideration is then given to whether pipeline operators, in transporting diluted bitumen, alter their operating and maintenance procedures in ways that can inadvertently make pipelines more prone to failure.

The following sections examine the potential sources of failure in pipelines from (a) internal degradation, (b) external degradation, and (c) mechanical forces. Because it is exposed to the shipped liquid, the inside of the pipe is the most obvious location to look for possible sources of damage from shipments. Corrosion is the main cause of internal degradation in crude oil transmission pipelines, followed to a lesser extent by erosion. Although the outside of the pipeline is not in contact with the shipped liquid, pipeline operating conditions associated with the shipment can affect the exterior of a transmission pipeline. Corrosion and cracking are the main sources of external degradation that can be affected by these conditions. Mechanical damage to the pipeline from overpressurization and outside forces also can be affected indirectly by the liquid in the pipeline.

### SOURCES OF INTERNAL DEGRADATION

Pipelines sustain internal damage primarily as a result of progressive deterioration caused by corrosion and erosion of the mild steel used to manufacture line pipe. Internal corrosion is an electrochemical process that typically causes damage to the bottom of the pipe when water is present. Erosion is a mechanical process that causes metal loss along the interior wall of the pipe because of the repeated impact of solid particles, particularly at bends and other areas of flow disturbance. Both forms of attack reduce pipe wall thickness and can penetrate the wall fully to cause leaks or decrease the strength of the metal remaining in the wall to produce a rupture. Internal corrosion is more prevalent than erosion in crude oil transmission pipelines. Both sources of internal pipeline damage are reviewed next, and the potential for diluted bitumen to affect their occurrence in crude oil transmission pipelines is assessed.

#### Internal Corrosion

The electrochemical process that causes iron in steel to corrode involves anodic and cathodic reactions. The main anodic reaction is the oxidative dissolution of iron. The main cathodic reaction is reductive evolution of hydrogen. The main species that contribute to a higher rate of corrosion are dissolved acid gases such as carbon dioxide (CO<sub>2</sub>) and hydrogen sulfide (H<sub>2</sub>S) as well as organic acids. For the electrochemical reactions to occur, an ionizing solvent must be present, which in the pipeline environment is usually water. Salts, acids, and bases dissolved in the water create the necessary electrolyte.

To prevent external corrosion, pipes are coated on the outside surface and cathodic protection is applied. In the case of internal corrosion, protecting the steel through the use of a coating or cathodic protection is impractical for various reasons. To prevent internal corrosion, therefore, pipeline operators try to keep water and other contaminants out of the crude oil stream and to design their systems so as to reduce places where any residual quantities can accumulate on the pipe bottom. They also use operational means to limit deposition, including maintenance of turbulent flow; periodic cleaning with pigs; and the injection of chemicals, called corrosion inhibitors, that disperse and suspend water in the crude oil and form a protective barrier on the pipe surface.

When crude oil is pumped from the ground, it is accompanied by some water and varying amounts of  $\text{CO}_2$  and  $\text{H}_2\text{S}$  as well as certain organic acids. Crude oil producers try to minimize these impurities in delivering a stabilized product to the transmission pipeline, but eliminating them is prohibitively expensive. Transmission pipelines carrying crude oil therefore typically have some small amount of water and sediment (usually less than 1 percent by volume), and dissolved  $\text{CO}_2$  and  $\text{H}_2\text{S}$  will exist in even smaller quantities. Of interest to this study is whether diluted bitumen contains any more of these corrosive contaminants than do other crude oils or whether these contaminants are more likely to settle and accumulate on the bottom surface of pipelines transporting diluted bitumen.

The various means by which water, sediment, dissolved gases, and other materials can cause internal corrosion of crude oil transmission pipelines are reviewed next.

#### *Water Deposition and Wetting*

Oil by itself is not corrosive to mild steel pipe in the temperature range in which transmission pipelines operate, which is typically well below  $100^\circ\text{C}$ . Water contact with the inside pipe wall is an essential precondition for internal corrosion. Pure water is not a significant source of corrosion when it acts alone. As discussed in more detail below, however, water in the presence of certain dissolved contaminants, such as  $\text{CO}_2$ ,  $\text{H}_2\text{S}$ , and oxygen ( $\text{O}_2$ ), will cause corrosion if the water is allowed to contact and wet the steel surface of the pipe. In theory, a pipeline carrying oil and a small amount of water will not experience internal corrosion if the water is dispersed and suspended in the oil rather than flowing as a separate phase in contact with the bottom of the pipe. The following factors can affect whether water falls out of the oil flow to cause water wetting of the steel surface:

- *Flow rate:* When oil and water move through a horizontal pipeline at low flow rates, gravitational force will dominate turbulent forces and cause the water to flow as a separate layer. As the rate of flow increases, the turbulence energy of the flow will increase, causing the water to become gradually more dispersed and entrained in the oil. The turbulence will cause water to break up into smaller droplets, and it will keep these finer droplets suspended.
- *Water content:* The more water present in the flow, the harder it becomes for the flowing oil to suspend all water droplets. Thus, water settles more readily when there is more of it in the pipeline stream.
- *Pipe diameter and inclination:* Water is more difficult to keep entrained as the diameter of the pipeline increases as long as other parameters remain the same, including the flow rate and physical properties of the crude oil. Pipe inclination has a comparatively small effect on the ability of oil to entrain water if the inclination is less than 45 degrees.



- *Physical properties of the oil and water:* The density and viscosity of water and oil play an important role in water entrainment and settling. In general, oils that have high density and viscosity are better able to entrain water than are lighter oils, in part because the density of a heavy oil will be close to that of water. Another important physical property is the oil and water interfacial tension, or tendency of the water and oil to mix or separate. Interfacial tension is affected by the presence of surface-active substances naturally found in the crude oil as well as by surfactant chemicals that may be injected into the flow by the pipeline operator.

- *Chemical additives:* Chemicals injected into the flow stream can significantly influence water entrainment, primarily by affecting interfacial tension. As explained in Chapter 2, pipeline operators add corrosion-inhibiting chemicals to the oil stream to adsorb onto the steel surface and provide a protective layer against corrosion and water wetting. Another benefit of these additives is that they usually contain surface-active compounds that decrease oil and water interfacial tension so as to make it more difficult for water to separate from the oil flow. Conversely, chemical demulsifiers that are added to oil to remove water during processing before delivery to the pipeline can have the undesired effect of increasing the interfacial tension and thus causing easier separation of oil and water in the pipeline flow. Finally, the drag-reducing agents that are sometimes added by pipeline operators to enhance throughput can lower the ability of flowing oil to entrain water by dampening turbulence.

### *Solids Deposition*

Solids in the crude oil stream settle to the pipe bottom for the same hydrodynamic reasons described above for water dropout. Typically the settled solids consist of a mix of inorganic and organic components. Sand, clay, detached scale, and corrosion products (such as carbonates and sulfides) are usually the main inorganic components of settled solids. Organic components commonly consist of asphaltenic and paraffinic compounds as well as other organic material formed by the action of microorganisms (Mosher et al. 2012; Friesen et al. 2012). The corrosive effect of microorganisms in pipeline deposits is discussed in more detail later in the section.

When the flow rate and associated turbulence are low, solids can settle and accumulate, particularly at the bottom of horizontal lines. When no water is present, the deposition of solids can impede flow to create a flow assurance problem. When the solids settle with water, the mix is often referred to as sludge. A porous layer of settled solids can retard corrosion by water containing aggressive species, because the solids will cover part of the steel surface and make it harder for those species to reach the surface. However, a porous layer of solids can also impede access to the steel surface by corrosion-inhibiting chemicals. In this case, the internal surface of the pipe that is covered by a layer of solids may corrode faster than the rest of the surface not covered by solids but protected by the chemical inhibitors. This adverse effect can be compounded by an unfavorable galvanic coupling between the unprotected area covered by the solids and the surrounding areas that are chemically inhibited.

The basic sediment and water (BS&W) content of a crude oil shipment, as described in the previous chapters, is a common measure of the amount of solids and water carried and can be used to predict the likelihood of deposit formation. Even when BS&W is very low (less than 0.5 percent by volume) and the fluid velocity is relatively high (>1 meter per second or >2 miles per hour), some accumulated solids and water may be found in low spots in the pipeline and in dead legs, where the flow rate is low or stagnant. Sludge deposits holding water containing the

dissolved gases, acids, and microorganisms discussed next are the source of a common form of localized internal corrosion commonly referred to as underdeposit corrosion.

#### *Corrosive Effect of CO<sub>2</sub>*

CO<sub>2</sub> dissolved in water can have a particularly corrosive effect in pipelines, as evidenced by the series of reactions that ensue (DeWaard and Milliams 1975). Water containing dissolved CO<sub>2</sub> that forms carbonic acid (H<sub>2</sub>CO<sub>3</sub>) and wets the pipe surface leads to the dissolution of iron (Fe) from the pipe steel and the evolution of hydrogen (H<sub>2</sub>) from the water. This weak acid partially dissociates in water to produce the bicarbonate ion (HCO<sub>3</sub><sup>-</sup>) and protons (H); in water the protons are present as hydronium ions (H<sub>3</sub>O<sup>+</sup>). Bicarbonate ions dissociate further to produce more hydronium ions and carbonate ions (CO<sub>3</sub><sup>2-</sup>). The hydronium ion is highly reactive as it seeks to obtain a missing electron from nearby species. In giving up electrons to hydronium ions, the iron atoms on the pipe surface are destabilized, and they dissolve in the water to form iron ions (Fe<sup>2+</sup>). By obtaining the resulting electrons, the hydronium ions are converted to dissolved hydrogen gas (H<sub>2</sub>). The corrosion by-product is iron carbonate (FeCO<sub>3</sub>), which may deposit on the steel surface and be protective in some cases.

Keeping CO<sub>2</sub> out of the crude oil stream is particularly important because the ensuing corrosion process can occur rapidly. The reason is that as the hydronium ions are consumed by the corrosion reaction, the carbonic acid dissociates further to replenish the reactive ions, which allows the corrosion process to continue at a fast rate. As long as there is sufficient CO<sub>2</sub> to produce the carbonic acid, the iron in pipe steel that is water wet will continue to corrode. The full series of chemical reactions involved in CO<sub>2</sub> corrosion is detailed in Box 5-1.

#### *Corrosive Effect of H<sub>2</sub>S*

H<sub>2</sub>S is another gas that may be present in the crude oil stream to create corrosive conditions inside pipelines when it is dissolved in water. Crude oil is often extracted with some amount of H<sub>2</sub>S. The concentrations in crude oil can be small [less than 100 parts per million (ppm) in the gas phase] or substantially larger. Other sulfur compounds in crude oil are less common, and they are typically soluble in oil rather than water, requiring high temperatures (>300°C) to become reactive (Nesic et al. 2012). Thus, their concentrations do not present a corrosion problem in transmission pipelines.

The reactions that cause H<sub>2</sub>S to corrode pipe steel are generally similar to those described for CO<sub>2</sub>. Like CO<sub>2</sub>, H<sub>2</sub>S gas is soluble in water. As a weak acid, the dissolved H<sub>2</sub>S behaves in a manner similar to carbonic acid (H<sub>2</sub>CO<sub>3</sub>) by providing a reservoir of reactive hydronium ions. An important difference is that the layer of protective iron sulfide (FeS) always forms on the steel surface as a result of the reactions involving H<sub>2</sub>S. Experimental evidence indicates that H<sub>2</sub>S corrosion initially proceeds by adsorption of the H<sub>2</sub>S to the steel surface. This adsorption is followed by a fast surface reaction at the steel and water interface to form a thin (about 1 micron) film of the iron sulfide mackinawite (Wikjord et al. 1980). The formation of mackinawite is an important factor governing the corrosion rate because the surface film can create a barrier that impedes the ability of other species to reach the steel. Accordingly, corrosion due to other contaminants such as CO<sub>2</sub> can be reduced when small amounts of H<sub>2</sub>S (in the low ppm range in the gas phase) are present in crude oil.

## Box 5-1

**CO<sub>2</sub> Corrosion of Mild Pipe Steel**

CO<sub>2</sub> gas dissolved in water forms a weak carbonic acid (H<sub>2</sub>CO<sub>3</sub>):

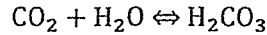

Carbonic acid partially dissociates in water to produce acidity [i.e., hydronium ions (H<sup>+</sup>); water is omitted for simplicity]:

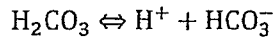

Further dissociation occurs in the bicarbonate ion (HCO<sub>3</sub><sup>-</sup>) to produce more H<sup>+</sup> and form carbonate ions (CO<sub>3</sub><sup>2-</sup>):

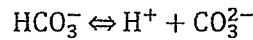

The surface atoms of iron (Fe) in the steel will readily give up electrons to hydronium ions and dissolve into the water in the form of iron ions (Fe<sup>2+</sup>):

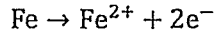

In obtaining the additional electron, the hydronium ion will form hydrogen gas (H<sub>2</sub>), and the reaction is complete.

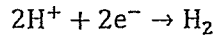

When the concentrations of the corrosion products in water (Fe<sup>2+</sup> and CO<sub>3</sub><sup>2-</sup> ions) exceed the solubility limit (typically at neutral and alkaline pH), they form solid iron carbonate on the surface of the steel:

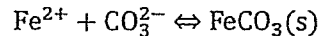

The layer of iron carbonate can become fairly protective and reduce the rate of underlying steel corrosion by blocking the surface and preventing the corrosive species from reaching it.

The rapid kinetics of mackinawite formation favor it as the initial product of H<sub>2</sub>S reactions. However, with time, and as H<sub>2</sub>S concentrations increase, mackinawite is less prevalent, and other forms of iron sulfide are seen, such as pyrrhotite. At high H<sub>2</sub>S concentrations, pyrite and elemental sulfur are formed. While layers of any iron sulfide will offer some corrosion protection, there is no well-defined relationship between the type of iron sulfide layer and the ensuing rate of corrosion. It is well understood that high H<sub>2</sub>S levels accompanied by elemental sulfur can lead to high rates of localized corrosion. However, elemental sulfur is usually associated with the production of natural gas with a high H<sub>2</sub>S content. For a crude oil to have similarly high H<sub>2</sub>S and elemental sulfur content would be unusual.

*Corrosive Effect of Oxygen*

Oxygen dissolved in water is undesirable in pipelines because it is highly reactive with iron. Corrosion generally becomes a problem when levels of dissolved oxygen reach those found in aerated surface water (typically about 8 ppm). Smaller amounts of oxygen (below 1 ppm) can become a problem when the oxygen reacts and impairs protective iron carbonate and iron sulfide

layers. In general, the water associated with oil production does not contain oxygen, and therefore such high concentrations are seldom observed in shipments of stabilized crude oil transported in pressurized pipelines with controlled air entry points. Oxygen may become elevated when air is introduced into the pipeline inadvertently. Air may be introduced during shutdowns for inspections and repairs. Chronic sources of air ingress, such as during injection of chemicals and in storage tanks holding liquids at atmospheric pressure, are potentially more problematic. Nevertheless, how and why these air entry points would differ from one crude oil shipment to the next in the same pipeline facility are not evident.

#### *Corrosive Effect of Organic Acids*

Organic acids with low molecular weights are water soluble and thus present a significant corrosion threat when they are found in settled water that wets the steel surface of crude oil pipelines. A common representative of the family of water-soluble organic acids is acetic acid ( $\text{CH}_3\text{COOH}$ ).<sup>1</sup> Other low-molecular-weight organic acids that can lead to corrosion of mild steel include propionic and formic acids. These weak acids create a corrosion scenario similar to the one described for  $\text{CO}_2$  attack, with the organic acid taking the place of carbonic acid. Much like carbonic acid, organic acids provide a reservoir of hydronium ions. Their corrosive effect is particularly pronounced at low pH and higher temperatures, when their abundance can increase corrosion rates dramatically. At a higher pH (>6), the corrosive effect of organic acids on mild steel is negligible, regardless of concentrations.

Other organic acids found in crude oil—and notably in bitumen—are compounds with high molecular weight, which are often referred to as naphthenic acids. While these organic acids can be a significant corrosion threat at the high temperatures (>300°C) reached in refineries, they are not a threat to pipe steel because they are not soluble in water but are rather dissolved in the oil phase (Nesic et al. 2012). Accordingly, high-molecular-weight organic acids do not pose a corrosion threat to steel at pipeline temperatures. In some crude oils these acids may even have moderately inhibitive properties (Nesic et al. 2012).

#### *Effect of Microbiologically Influenced Corrosion*

The term microbiologically influenced corrosion (MIC) is used to designate the localized corrosion affected by the presence and actions of microorganisms (Little and Lee 2007). The types of damage that can be caused by these microorganisms are not unique, which means that MIC cannot be identified by visual inspection of the damage. Although MIC is discussed here with respect to internal corrosion, it can also contribute to corrosion on the outside of the pipe, as noted later.

Microorganisms that cause MIC are bacteria, archaea, and fungi. Some occur naturally in crude oils, while others may be introduced as contaminants from air, sediment, and water. The temperature range in which these organisms can grow is that in which liquid water can exist, approximately 0°C to 100°C (32°F to 212°F) (Little and Lee 2007). However, individual groups of microorganisms have temperature optima, including sometimes narrow ranges, for growth. The temperature range over which transmission pipelines operate will therefore select for specific microorganisms, but it will not prevent microbial growth.

---

<sup>1</sup> A household name for acetic acid is vinegar, which consists of 2 to 3 percent acetic acid dissolved in water.

For microorganisms to grow and proliferate, they require not only liquid water but also nutrients and electron acceptors for respiration. Accordingly, how microorganisms use water, nutrients, and electron acceptors to grow and how they influence corrosion is explained, and consideration is then given to whether levels of any of these essentials are likely to be affected by diluted bitumen.

**Water Availability** Microbial growth is limited by the availability of liquid water. Growth is therefore concentrated at oil–water interfaces and in the aqueous phase, including the water in deposits of sludge in pipelines. The volume of water required for microbial growth in hydrocarbon liquids is extremely small (Little and Lee 2007). Because water is a product of the microbial mineralization of organic substrates, microbial mineralization of hydrocarbon can generate the additional water needed for proliferation.

**Nutrient Availability** Microorganisms need suitable forms of carbon, nitrogen, phosphorus, and sulfur as nutrients (Little and Lee 2007).<sup>2</sup> In oil pipelines, hydrocarbons can be degraded by aerobic or anaerobic processes to yield assimilable carbon. Aerobic degradation of hydrocarbons is faster than anaerobic degradation, with the rate depending on the specific electron acceptors used in the process. In general, the susceptibility of hydrocarbon compounds to degradation can be ranked as follows: linear alkanes, branched alkanes, small aromatics, and cyclic alkanes (Atlas 1981; Das and Chandran 2011; Perry 1984). As the chain length of alkanes increases, bacteria show decreasing ability to degrade these compounds (Walker and Colwell 1975). Some high-molecular-weight polycyclic aromatics may not be degraded at all (Atlas 1981). As a practical matter, however, carbon availability is often not the main constraint for crude oil biodegradation. Both nitrogen and phosphorus are required for microbial growth. Low concentrations of assimilable forms of these elements can limit biodegradation.<sup>3</sup>

**Electron Acceptors** Microorganisms can use a variety of electron acceptors for respiration. In aerobic respiration, energy is derived when electrons are transferred to oxygen, which is the terminal electron acceptor. In anaerobic respiration, a variety of organic and inorganic compounds may be used as the terminal electron acceptor, including sulfate, nitrate, nitrite, iron (III), manganese (IV), and chromium (VI) (Little and Lee 2007). Anaerobic bacteria can therefore be grouped on the basis of the terminal electron acceptor, such as sulfate-, nitrate-, and metal-reducing bacteria.<sup>4</sup> In petroleum environments, the bacteria most often associated with MIC are sulfate reducers. In anaerobic environments, sulfate reducers produce H<sub>2</sub>S when they use the sulfate as an electron acceptor.<sup>5</sup> In addition, many archaea can produce sulfides, and therefore the inclusive term for this group of anaerobes is sulfide-producing prokaryotes (SPP).

SPP-related corrosion of metals used in oil exploration and production has been reported around the world (Mora-Mendoza et al. 2001; Ciaraldi et al. 1999; El-Raghy et al. 1998; Jenneman et al. 1998). A main concern is that these microorganisms produce H<sub>2</sub>S. As discussed

---

<sup>2</sup> A representation of the major elements required for a typical microorganism composition is C<sub>169</sub>(H<sub>280</sub>O<sub>80</sub>)N<sub>30</sub>P<sub>2</sub>S.

<sup>3</sup> Atlas (1981) reported that when a major oil spill occurred in marine and freshwater environments, the supply of carbon was significantly increased and the availability of nitrogen and phosphorus generally became the limiting factor for oil degradation.

<sup>4</sup> There is specificity among anaerobes for particular electron acceptors. Facultative anaerobic bacteria can use oxygen or other electron acceptors. Obligate anaerobic microorganisms cannot tolerate oxygen for growth and survival. Obligate anaerobic bacteria are, however, routinely isolated from oxygenated environments associated with particles and crevices and, most important, are in association with other bacteria that effectively remove oxygen from the immediate vicinity of the anaerobe.

<sup>5</sup> Some anaerobes can also reduce nitrate, sulfite, thiosulfate, or fumarate (Little and Lee 2007).

earlier, H<sub>2</sub>S reacts with the iron ions to form a thin layer of the iron sulfide mackinawite that adheres to the steel surface. In the absence of oxygen, and if the concentration of iron ions in the solution is low, this mineral layer will protect the iron in the steel pipe surface from dissolution (Wikjord et al. 1980). However, if oxygen is introduced, the iron sulfide can be converted to an iron oxide and elemental sulfur, which will cause the rate of corrosion to increase substantially for reasons already given.<sup>6</sup> Pipelines operators, therefore, seek to prevent the formation of colonies of SPP and other microorganisms in pipelines through design, operations, maintenance, and chemical means.

### **Internal Erosion**

Solid particles flowing in the crude oil stream can cause erosion of pipe wall, particularly at flow disturbances such as pipe bends. The propensity for erosion is affected by the pipe material; angles of flow impact; flow velocity; and the amount, shape, mass, and hardness of solid particles in the stream. While pipeline erosion is common in the oil production industry, it occurs to a greater extent in production (field) pipelines that contain fluids with high levels of sand and minerals. For example, slurry flow in the pipelines used to move oil sands ore before bitumen extraction can be highly abrasive (Zhang et al. 2012). Because processed crude oils do not contain similarly high concentrations of solids, erosion is not observed to a significant degree in transmission pipelines. Of interest to this study is whether the diluted bitumen delivered to transmission pipelines contains significantly higher concentrations of abrasive solids than do other crude oils and whether it is transported at higher flow rates conducive to erosion.

### **Assessment of Effects of Diluted Bitumen on Sources of Internal Degradation**

The properties of diluted bitumen as they pertain to the identified factors affecting susceptibility to internal degradation from corrosion and erosion are examined next.

#### *Internal Corrosion*

**Water Wetting and Solids Deposition** An important factor in water dropout and wetting is the total water content of the crude oil stream, which is measured by pipeline operators as part of shipment BS&W sampling. As reported earlier, Canadian transmission pipelines require that crude oil shipments not have a BS&W exceeding 0.5 percent. These levels are comparable with, and more often lower than, the levels commonly required by U.S. transmission pipelines. Accordingly, the level of water contained in shipments of diluted bitumen and other crude oils imported by pipeline from Canada will not be higher than that contained in shipments of other crude oils piped in the United States.

Even relatively small amounts of water in crude oil can settle to the pipe bottom. In considering the propensity of water to drop out of the oil stream, important factors include the viscosity, density, and surface tension of the oil and whether it is transported in a flow that is sufficiently turbulent to disperse and suspend water droplets. Shipments of diluted bitumen are

---

<sup>6</sup> The impact of oxygen on corrosion from anaerobic SPP was examined by Hardy and Bown (1984) by using mild steel and weight loss measurements. Successive aeration–deaeration shifts caused variations in the corrosion rate. The highest corrosion rates were observed during periods of aeration. Hamilton (2003) concluded that oxygen was the terminal electron acceptor in all MIC reactions. In laboratory seawater and fuel incubations, Aktas et al. (2013) demonstrated that there was no biodegradation of hydrocarbon fuels, little sulfate reduction, and no corrosion of carbon steel in the absence of oxygen.

transported at the same pressures and under the same turbulent flow regimes as shipments of other heavy crude oils. The report has demonstrated that diluted bitumen is more viscous than light and medium-density crude oils and is comparable in viscosity with heavy crude oils. A stream of diluted bitumen in turbulent flow should therefore confer the beneficial effect, relative to lighter crude oils, of dispersing and suspending any free water that may exist in the pipeline stream.

A low likelihood that a shipment of diluted bitumen contains water that will settle and wet the bottom of the pipeline will lead to a low likelihood of internal corrosion regardless of the corrosion mechanism or the presence of other contaminants that can contribute to corrosion. All crude oil shipments can carry particles consisting of sand, clay, organic materials, and hydrocarbons that have the potential to drop out of the stream at vulnerable locations in the pipelines. Given its high viscosity, diluted bitumen will suspend the very fine particles that may be contained in its sediment. The solids contained in diluted bitumen are not unusual in quantity or particle size but are within the range of other heavy crude oils, as established in the earlier comparisons. Whether any of the sediments that settle to the pipe bottom threaten underdeposit corrosion will depend critically on associated water, as well as the presence of corrosive gases, acids, and microorganisms.

**Corrosive Gases (CO<sub>2</sub>, H<sub>2</sub>S, and Oxygen)** If water does settle and wet the bottom of a pipeline carrying diluted bitumen, such as at low spots and dead legs, consideration of whether shipments of this type of crude oil contain comparatively high levels of dissolved gases that will increase the potential for corrosion is warranted. Data on the CO<sub>2</sub> contained in crude oil lines, including those carrying diluted bitumen, are not readily available. Nevertheless, concentrations can be inferred from the CO<sub>2</sub> levels present at the last point of gas-liquid separation upstream of delivery to the transmission pipeline. As is the case for shipments of other crude oils, various tanks will hold shipments of diluted bitumen before they are delivered to the transmission pipeline facility. This upstream storage, which occurs at atmospheric pressure, will provide the same opportunity for shipments of diluted bitumen as it does for shipments of other crude oils to degas CO<sub>2</sub> before entry to transmission pipelines. Such a comparable upstream environment will produce similarly low CO<sub>2</sub> concentrations and corrosion rates.

Likewise, the quantities of H<sub>2</sub>S reported for diluted bitumen (>25 parts per million by weight in liquid phase), as reported in Chapter 3, are lower than in many other crude oils and do not pose a corrosion threat. Even if other corrosive agents are present, the small concentrations of H<sub>2</sub>S would contribute little to the corrosive effect, except perhaps to provide a mildly mitigative impact because of the formation of protective iron sulfide layers. The conclusion is that concentrations of dissolved CO<sub>2</sub> and H<sub>2</sub>S in diluted bitumen shipments are likely to be low and not greater than those found in other crude oil shipments that are stored and transported similarly.

Transmission pipeline operators restrict air entry points to prevent ingress of oxygen. There are no data on the oxygen content in crude oil pipelines to assess the effectiveness of these restrictions. However, diluted bitumen is transported in the same pipelines as other crude oils, and the number of air entry points can be assumed the same and purposefully restricted. Because crude oils are stored by pipeline operators in large atmospheric pressure tanks, the possibility of air ingress cannot be eliminated, but the ingress will be as low for shipments of diluted bitumen as it is for shipments of other crude oils stored similarly. Even if some free water is assumed to settle to the bottom of a pipeline carrying shipments of diluted bitumen, low levels of oxygen

(e.g., below 1 ppm) will not constitute a serious corrosion threat or one that differs from that of a pipeline carrying shipments of other crude oils.

**Acids** In reviewing the chemistry of diluted bitumen in Chapter 3, no evidence emerged that it contains relatively high levels of low-molecular-weight organic acids such as acetic acid. The high total acid number of diluted bitumen derives from the presence of high-molecular-weight organic acids. These oil-soluble naphthenic acids do not pose an internal corrosion threat under pipeline conditions and may have mitigative effects on corrosion. The acid contained in diluted bitumen is therefore not a threat to internal corrosion of transmission pipelines.

**Microbiologically Influenced Corrosion** To understand whether diluted bitumen is more likely than other crude oils to cause MIC, it is helpful to examine whether this crude oil is more prone to providing the essential resources required for microbial growth. The water content of diluted bitumen shipments is comparable with that of other crude oil shipments, and diluted bitumen does not have constituents or operating requirements that make pipelines more prone to forming sludge that can harbor microorganisms. The other essential resources that deserve consideration are the availability of critical nutrients (especially carbon and nitrogen) and electron acceptors (especially oxidized sulfur compounds).

While microbial growth requires carbon, it may be limited more by the scarcity of nitrogen in petroleum. As reported earlier, most of the nitrogen in bitumen is bound in carbon structures and unavailable.<sup>7</sup> Lighter oils provide a more readily available source of degradable carbon than do heavy oils, including bitumen. The percentage of low-molecular-weight hydrocarbons is similar in diluted bitumen and other heavy crude oils and lower than the percentages in lighter crude oils. More of the carbon in diluted bitumen is contained in relatively high concentrations of asphaltenes. The molecular weight and structure of asphaltenes vary, but biodegradation of these compounds is an extremely slow process that does not provide a readily available source of carbon for microorganisms (Pineda-Flores and Mesta-Howard 2001).

With regard to the availability of electron acceptors, it was reported earlier that sulfur content is higher in diluted bitumen than in many other crude oils, but the sulfur is not in oxidized forms available for sustained sulfate reduction by SPP. Furthermore, the high sulfur content of bitumen is not correlated with high H<sub>2</sub>S content. Most of the sulfur in bitumen is organic sulfur bonded to carbon in heterocyclic rings, which are not easily degraded by microorganisms and thus largely unavailable for metabolism.

In sum, the chemistry of diluted bitumen is not more favorable for microbial growth and activity than is that of other crude oils.

### *Erosion*

The propensity for erosion is affected by the presence and physical properties of the solid particles in the stream, pipe material, angles of particle impact, and impact velocity. Pipe materials and impact angles are the same for diluted bitumen as for other crude oils transported through the same pipelines. Chapter 3 indicated that the velocity of diluted bitumen flowing through pipelines is not higher than the velocity of other crude oil flows. Furthermore, the diluted bitumen imported by pipeline into the United States is produced by using in situ methods that limit the amount of sand, minerals, and other solid particles recovered with the bitumen. The

---

<sup>7</sup> See Chapter 3.



extracted bitumen is processed to remove water and solids to achieve the requisite BS&W for pipeline transportation to yield solids levels that are similar to those of other crude oil shipments. While limited data are available on the specific physical properties of the solid particles in diluted bitumen, the generally low levels of solids (less than 0.05 percent) do not suggest that shipments of diluted bitumen increase the already low potential for erosion in crude oil transmission pipelines.

#### *Summary of Effects on Sources of Internal Degradation*

A review of product properties relevant to internal pipeline corrosion and erosion does not indicate that diluted bitumen is more likely than other crude oils to lead to these failure mechanisms. Shipments of diluted bitumen do not contain unusually high levels of water, sediment, dissolved gases, or other agents that can cause internal corrosion. The organic acids contained in diluted bitumen are not corrosive to steel at pipeline temperatures. Diluted bitumen has density and viscosity levels comparable with those of other crude oils, and it flows through pipelines with velocity and turbulence comparable with other crude oils so as to limit the accumulation of corrosive deposits. On the basis of an examination of the factors influencing microbial growth and activity, shipments of this crude oil do not have a higher likelihood than other crude oil shipments of causing MIC in pipelines. Because it has solids content and flow regimes comparable with those of other crude oils, diluted bitumen does not have a higher propensity to cause erosion of transmission pipelines.

## **SOURCES OF EXTERNAL DEGRADATION**

### **External Corrosion**

External corrosion of pipelines is usually characterized by uneven metal loss over localized areas covering a few to several hundred square centimeters of the outside steel surface of the pipe (Beavers and Thompson 2006). The electrochemical reactions that are involved usually occur at physically separate locations on the surface. While the anodic reaction is primarily oxidation of iron, the cathodic reaction can be either the hydrogen evolution that occurs in the anaerobic electrolyte trapped under an impermeable pipe coating or the reduction of oxygen under a permeable coating. The water and soluble compounds needed to create the electrolyte can be present in the soil surrounding the buried pipe or in the atmosphere when a pipe is above grade. In addition, a portion of external corrosion incidents involve MIC (Koch et al. 2002; Beavers and Thompson 2006). As discussed later in the section, external corrosion pits can also be sites for the formation and growth of stress corrosion cracks.

External corrosion is thus affected by the pipe material, the corrosivity of the environment, and the performance of coatings and cathodic protection systems. For mild grades of carbon steel commonly used in transmission pipelines, the main concern is the corrosivity of the surrounding environment and the performance of coatings and cathodic protection systems. Although the transported product does not come in contact with either the coating or the environment surrounding the pipeline, it can influence both factors by affecting the operating pressure and temperature of the pipeline.

Because pipeline segments are located below and above ground, they can be exposed to corrosive conditions in the soil and atmosphere. Many factors affect soil corrosivity, including moisture and oxygen content, electrical resistivity, pH, temperature, porosity, microbial activity, and the presence of dissolved salts (Uhlig and Revie 1985; Escalante 1989; Beavers and Thompson 2006). For pipeline segments exposed to the atmosphere, the primary environmental factors influencing corrosion are relative humidity, salt deposition, pollution, and temperature. Operating pressure does not affect these corrosive conditions, but elevated pipeline temperatures and resulting heat flux to the air or soil medium can increase corrosion rates.

Pipeline temperature and pressure can both affect the condition and performance of coatings and cathodic protection systems. As discussed in Chapter 2, coatings provide a barrier between the pipe and the corrosive environment. Coatings can fail in a variety of ways including disbonding from the steel surface. In pipelines using some older coating technologies, such as asphalt mastic systems, elevated temperatures can cause the coating material to deform and potentially reduce surface coverage. Elevated pipeline temperatures can also result in degradation of adhesive properties and increase the diffusion of moisture through the coating in the direction of the steel surface. Moisture diffusion can cause swelling of the coating relative to the steel and bring about increased surface stresses that lead to disbondment. Fluctuating line pressures can cause interfacial strain between the coating and the pipe surface to produce mechanical disbondment of the coating.

An intact coating that prevents contact between the corrosive environment and the steel surface will generally prevent external corrosion. However, all coatings contain some defects that expose the steel. Accordingly, a critical defense against external corrosion is the application of cathodic protection. As discussed in Chapter 2, many cathodic protection systems use an electric current to prevent corrosion where coating coverage is imperfect. Temperature and pressure conditions that cause coating disbondment, therefore, can be more problematic if they impede, or shield, the distribution of cathodic current to sites where steel is exposed. An advantage of modern coating systems, such as fusion bonded epoxy, is that they are compatible with cathodic protection. Shielding is nevertheless a problem observed in some older pipelines wrapped with impermeable tapes and at girth welds treated with field applied shrink sleeves.

## Cracking

The potential for transported products to affect the two main forms of cracking in pipelines is reviewed. Consideration is given to the mechanical process of fatigue cracking and forms of environmentally assisted cracking (EAC) that involve interactions of mechanical and corrosion processes.

### *Fatigue Cracking*

Fatigue is characterized by the formation and growth of microscopic cracks on one or both sides of the pipe wall.<sup>8</sup> The first stage in the fatigue process is crack initiation, or nucleation. Nucleated cracks do not cause a fracture, but some may coalesce into a dominant crack as the variable amplitude loading continues. In the second stage, the dominant crack grows in a more stable manner and may eventually reach the thickness of the wall to produce a leak. Alternatively, the dominant crack may grow to a critical length and depth that the pipe steel can

---

<sup>8</sup> See Beavers and Thompson (2006) for additional description of stress cracking processes.

no longer endure, leading to a rupture. Pipeline internal and external surface conditions caused by factors other than fatigue can lead to initial cracks or enhance crack fatigue crack growth from stress concentration. These factors can include preexisting dents, weld defects, corrosion pits, manufacturing flaws, and damage incurred during pipe transportation to the installation site.

Fatigue cracking can ensue as a result of repetitive, or cyclic, stress loadings on a pipe. Cyclic stresses can be axial (parallel to the axis of pipeline), circumferential (stress in the tangential direction), or radial (perpendicular to the axis). Circumferential, or hoop, stress is usually the most important source of cyclic loadings because the stress created by internal pressure is normally the largest stress on the pipeline.

Because viscous crude oils create more friction, they will require a higher operating pressure than do less viscous crude oils to achieve the same flow rate. In practice, pipeline operators reduce the flow rate when they transport viscous crude oils rather than increase operating pressure. Operating pressure cannot be increased if the pipeline is at the stress limit prescribed in regulations. Thus, only when a pipeline is operating below its stress limit can operating pressure be raised to increase the flow rate of a viscous crude oil.

The pipe segments vulnerable to cracking are those with preexisting flaws or dents and other surface deformities caused by mechanical forces during installation or while in service. Stresses can concentrate at these damage sites, enabling cracks to form and grow after a relatively small number of load cycles, a phenomenon known as low-cycle fatigue.<sup>9</sup> Other locations on the pipe susceptible to stress concentrations include discontinuities at longitudinal and girth welds and at voids formed during pipe manufacturing (Zhang and Cheng 2009).

Pressure cycling is reported to have contributed to fatigue failures in crude oil transmission pipelines. An example is the July 2002 rupture of a 34-inch crude oil pipeline near Cohasset, Minnesota (NTSB 2004). In that incident, the originating crack formed at the seam of the longitudinal weld as a result of vibrations experienced during railroad transportation of the pipe to the installation site. According to the National Transportation Safety Board report, the preexisting crack grew to reach a critical size in response to pressure cycling stresses associated with normal in-service operations.

### *Environmentally Assisted Cracking*

EAC results from the combined action of a corrosive environment and a cyclic or sustained stress loading. In general, EAC emerges in three basic forms: corrosion fatigue, stress corrosion cracking (SCC), and hydrogen-assisted cracking. EAC requires both a sufficient stress and a corrosive environment specific to the metal and thus is rare in crude oil transmission pipelines. However, when EAC failures do occur, they can be destructive; for example, the 2010 failure of a pipeline near Marshall, Michigan, was caused by EAC (NTSB 2012).

Corrosion fatigue cracking arises from a combination of corrosion and the same pressure-related cyclic stresses that produce fatigue cracking. In corrosion fatigue, the stresses sufficient to cause failure can be less severe because of the corrosion reaction and resulting damage. For example, corrosion pits can become stress concentrators that allow normal in-service pressure cycling to cause the formation and growth of cracks in the pit. In the case of pipeline SCC, the same corrosive factors may exist, but the main acting stress is the sustained hoop forces generated by the operating pressure as well as its cycling. The acting stress may also be residual

---

<sup>9</sup> Conversely, high-cycle fatigue occurs under a low-amplitude loading in which a large number of load cycles is required to produce failure.

in nature, introduced during bending and welding in manufacturing, or it may arise from external soil pressure or differential settlement. The same locations on the pipe that concentrate cyclic stresses, such as dents, scrapes, and other surface discontinuities, can concentrate static stresses. Furthermore, breaks in the surface film may occur at these discontinuities to make the area more prone to electrochemical corrosion.<sup>10</sup>

The factors that create corrosive environments enabling EAC, such as soil properties and the performance of coatings and cathodic protection, have already been discussed with respect to external corrosion. As with external corrosion, the maintenance of coating performance and cathodic protection is critical in controlling EAC (CEPA 2007). In the case of SCC, limiting the introduction of residual stresses during pipe manufacturing, transportation, and installation is also important in reducing susceptibility. Operating pressure is the major in-service source of static hoop stress. Lowering the operating pressure of a pipeline would be expected to reduce the potential for SCC. However, the specific relationship between SCC and hoop stress is not well established. For example, SCC failures have occurred in pipelines experiencing hoop stresses that have varied from 46 to 77 percent of the specified minimum yield strength of the pipeline.<sup>11</sup> Accordingly, adjusting operating pressures as a way to prevent SCC can be difficult.

EAC can be caused or exacerbated by hydrogen-assisted cracking. For example, when sources of hydrogen are present—such as from agents in the crude oil stream (e.g., H<sub>2</sub>S) or from external sources (e.g., excessive cathodic protection voltage)—cracking potential may increase. Although hydrogen-assisted cracking is rare in crude oil transmission pipelines, it can occur as a result of the diffusion and concentration of atomic hydrogen at the crack tip or other microstructural trap site in a metal. The ingress of hydrogen into a metal is enhanced in the presence of sulfur species. The trapped hydrogen can cause internal stresses within the metallurgical structure favorable to enhanced cracking or act to reduce local roughness in the region of the crack tip. Hydrogen can also adsorb to the metal surface to reduce surface energy and migrate into the microstructure, thereby reducing interatomic bond strength and providing nucleation sites for cracks. Hydrogen-assisted cracking can occur on the inside or outside of the pipe, depending on the source of the hydrogen and its ability to reach the pipe surface.

### **Assessment of Effects of Diluted Bitumen on Sources of External Degradation**

Because diluted bitumen only contacts the inside of a pipeline, it can contribute to external degradation only indirectly. In the case of external corrosion and EAC, one concern is that elevated operating temperatures can adversely affect the performance of the coating as a barrier to corrosion. The relevant question with respect to both external corrosion and EAC is whether diluted bitumen creates operating temperatures and pressures that are sufficiently different from those of other crude oils to increase coating disbondment. As has been reported, diluted bitumen and other heavy crude oils have similar densities and viscosities and flow through pipelines at the same rate and within comparable pressure and temperature ranges (see Chapter 3, Tables 3-4 and 3-7). For this reason, the likelihood of coating degradation and any associated external damage resulting from the operating parameters of diluted bitumen should be equivalent to that of other crude oils with comparable density and viscosity.

---

<sup>10</sup> At sites of surface damage, such as dents and corrosion pits, stress levels in the circumferential and axial directions are higher than on undamaged portions of the pipe surface.

<sup>11</sup> National Energy Board, notes from January 12, 1996, meeting between National Energy Board SCC Inquiry Panel and Camrose Pipe Company Ltd., Exhibit No. A-58.

Pipelines transporting diluted bitumen and other heavy crude oils should not differ in the stress loadings generated by their transportation because operating pressures are comparable. Other sources of static stress, such as residual stresses from pipe fabrication and installation, would not be affected by the product in the pipeline. Transmission pipelines, therefore, should not experience more stress cracking from transporting diluted bitumen than from transporting other crude oils of similar density and viscosity.

Finally, if the exterior coating of the pipe disbonds, hydrogen may diffuse into the surface metal with a rate of uptake and subsequent potential for embrittlement that will depend on a number of factors, including pH and temperature. However, the operating parameters of diluted bitumen should not increase the potential for coating disbondment. With respect to the interior of the pipeline, the availability of H<sub>2</sub>S and free sulfur to form hydrogen in diluted bitumen is relatively low. Thus, transporting diluted bitumen is not likely to increase the potential for hydrogen-assisted cracking.

## SOURCES OF MECHANICAL DAMAGE

Mechanical damage to the pipeline and its components can occur as a result of overpressurization or outside forces. Mechanical forces can cause an immediate, and sometimes catastrophic, breach and release or make the pipeline more susceptible to releases by destabilizing support structures and damaging other components such as valves, joints, and other fittings. Damage from mechanical forces can also weaken the resistance of the pipeline to other failure mechanisms. Sites on the pipeline that sustain even light damage, such as scrapes, are vulnerable to corrosion attacks and stress-related cracking. Accordingly, consideration of whether the transportation of diluted bitumen creates an elevated potential for phenomena that can lead to mechanical damage is warranted.

### Overpressurization

Various events can generate excessive pressure in a pipeline, including surges, thermal overpressure, column collapse, and human error. If the pipe is already weakened by corrosion, cracking, or deformities from earlier mechanical damage, overpressure events can increase the potential for damage and failure.

Pipeline operators prevent overpressure events through personnel training; standardized procedures; system design; and safety systems such as pressure relief valves, pressure switches, surge tanks, and bypass systems. Nevertheless, excessive pressure in a pipeline can occur as a result of operator error, thermal overpressure, and column separation. A transported fluid that increases the likelihood of any of these outcomes could increase the potential for mechanical damage.

### *Surge*

Any action in a pipeline system that causes a rapid reduction in the velocity of the transported fluid could cause a pressure surge. Transient, high-amplitude pressure waves, or surges, are not normal and can cause mechanical damage to pipes, components (e.g., valves, seals, joints), instrumentation (e.g., meters and gauges), and support structures. Because all crude oils have

relatively high bulk modulus (incompressibility), they have a comparable propensity for energy to be transferred in high-pressure waves when events trigger abrupt reductions in flow velocity.

#### *Operator Error*

Overpressurization can be caused by direct human error. Unintentional pumping of fluids against a closed valve with coincidental failure of pressure switches, pressure relief valves, and other protective devices is an example of a rare-event overpressurization scenario. Most pipelines are equipped with safeguards such as pressure switches and relief devices to avoid damage from these scenarios. If a transported liquid adds complexity to operational requirements, operator errors could increase.

#### *Column Collapse*

Pressure surges can arise from pressure differentials, or slack conditions, in the pipeline. A slack line can occur when the liquid being transported develops a vapor void at a point in the pipeline where line pressure drops below the vapor pressure of the liquid. The void will temporarily restrict the flow of liquid. When the void collapses, a pressure wave comparable with that of a rapid valve closure can be produced. The transformation of the liquid into a vapor phase is known as column separation. To prevent the occurrence of column separation, pipeline operators strive to maintain line pressure above the vapor pressure of the liquid. Locations vulnerable to pressure differentials are elevation peaks and the downstream side of slopes. A liquid that has certain properties, such as a relatively high fraction of hydrocarbons with high vapor pressure, can theoretically increase the potential for column separation.

#### *Thermal Overpressure*

A pipe segment that is full of liquid will experience a rapid pressure increase when it is exposed to a heat source and when volume expansion is restricted. Special procedures and thermal relief valves are used to prevent this occurrence in aboveground pipe segments where the flow may be impeded or blocked and the segment may be subsequently exposed to a heat source such as sunlight or fire. Because the chemistry of the trapped fluid determines the amount of pressure increase corresponding to an incremental increase in temperature, some transported liquids could have greater potential for thermal overpressure.

#### **Outside Force Damage**

Pipelines can sustain external mechanical damage from both natural forces and human activity. Natural forces include seismic movements and other ground shifts, such as those from landslides and subsidence. Examples of damage from human activity include accidental strikes from vehicles, earth moving activity, and surface loading by farm equipment. Intentional damage to a pipeline, or sabotage, is a potential source of mechanical damage, although it is rare.

There are ways in which the contents of a pipeline can affect or interact with an outside force failure mechanism. One possibility is that a denser, heavier fluid adds weight to a pipe that is free-spanning (i.e., unsupported) or traverses a terrain susceptible to inadequate support. Another possibility is that the heat flux from a fluid transported at an elevated operating

temperature reduces the stability of a pipeline in a frost zone. Similar interactions with the outside environment related to pipe vibrations, expansion, and contraction may be postulated as potential sources of mechanical damage.

### **Assessment of Effects of Diluted Bitumen on Sources of Mechanical Damage**

Mechanical damage to the pipeline and its components can occur as a result of outside forces and overpressurization events. Several causes of outside force damage that could be affected to some degree by the properties of the transported liquid have been postulated. The most relevant properties of the transported liquid are density, viscosity, and operating temperatures. However, because these properties are the same for diluted bitumen as many other crude oils, there is no reason to believe their interactions with outside forces will differ. The same conclusion can be reached concerning the potential for mechanical damage due to chemical or physical properties that can affect the propensity for surge, column separation, or thermal expansion. The potential for these sources of mechanical damage should be indistinguishable from that of other crude oils. Diluted bitumen is blended like many other crude oils to remain fully mixed in the pipeline environment and it does not contain a high percentage of light (high vapor pressure) hydrocarbons.

## **EFFECTS ON OPERATIONS AND MAINTENANCE PROCEDURES**

The preceding analysis has consistently found that the properties of diluted bitumen are within the range of other crude oils. These findings do not indicate a need for operations and maintenance (O&M) procedures that are customized to diluted bitumen, nor do they suggest that pipeline operators apply O&M procedures in transporting diluted bitumen that are different from those applied in transporting other crude oils with similar properties. Of course, if operators who traditionally carry only light crude oils do not make appropriate adjustments to line pressure and flow rates when they transport diluted bitumen or any other similarly dense and viscous crude oil, a greater potential for some of the failure mechanisms examined above could result.

Because most pipeline operators transport many varieties of crude oil, they routinely make adjustments to operational parameters to accommodate different crude oil grades. There is no reason to believe that operators fail to make these adjustments when they transport heavy crude oils generally or, more specifically, when they transport diluted bitumen. Nevertheless, to be comprehensive, a search was undertaken for evidence of O&M practices being altered in inadvertent ways that could be detrimental to pipeline integrity.

### **Operational Procedures**

As discussed in Chapter 2, the operation of most pipelines is monitored and controlled by a combination of local and remote systems by using a centralized supervisory control and data acquisition system. Instrumentation at pump stations, tank farms, and other facilities includes sensors, programmable logic controllers, switches, and alarms. Remote systems allow for monitoring and coordination at centralized locations distant from the pipeline facilities. Together, these local and remote capabilities provide protection against abnormal operations—for example, by allowing for the orderly shutdown of pumps and cessation of flow if an alarm

condition occurs or if certain operating parameters are violated. Maintaining the integrity of control systems is essential in ensuring safe pipeline operations.

Therefore, whether there are any characteristics of diluted bitumen that could introduce more complexity into or otherwise compromise the satisfactory functioning of pipeline control systems and their components is worth investigating. As previously noted, none of the chemical and physical properties of diluted bitumen suggests that such an effect could be expected, because the properties fall within the range of other crude oils commonly transported by pipeline. Nevertheless, the committee undertook a search of any instances in which operators modified or were advised to modify their standard control and monitoring activities in transporting diluted bitumen. A search of published documents did not reveal any noteworthy reports, special standards, or guidance documentation. In consulting Canadian pipeline operators (see Appendix A), the committee asked whether the transportation of diluted bitumen required changes to set points for safety and control instrumentation. The response was as follows: “There are no differences. Standards and procedures are in place for control that are generic for all crude oil commodities shipped. The standards and procedures are structured to ensure safe operation regardless of the commodity.” Likewise, all pipeline operators interviewed in public meetings convened by the committee stated that transporting diluted bitumen did not require different control or monitoring procedures.<sup>12</sup>

In its investigation of the July 25, 2010, EAC-related rupture near Marshall, Michigan, the National Transportation Safety Board found that the control center made repeated errors by increasing the delivery rate of the pipeline under the impression that low-pressure readings caused by the undetected rupture were indicative of slack line conditions caused by column separation (NTSB 2012). The product released in the incident, discussed in Chapter 4, was diluted bitumen. The phenomenon of column separation has already been reviewed, and no evidence that diluted bitumen has properties associated with it was found. Furthermore, the National Transportation Safety Board did not indicate that the shipment of diluted bitumen that was being delivered through the ruptured pipeline had actually experienced column separation or that any of the properties of the shipment had any other specific effect on the actions of the control center.

### **Maintenance Procedures**

As described in Chapter 2, pipeline operators use various methods for preventing, detecting, and mitigating damage in pipelines. Methods for preventing external cracking and corrosion include use of coatings and cathodic protection. Methods for preventing internal corrosion include chemical treatments, flow maintenance, and in-line cleaning. Operators also monitor pipeline conditions by using various inspection tools, probes, and surveys. If transporting diluted bitumen compromises the ability of operators to carry out any of these activities, more adverse conditions could arise and persist and thereby increase the potential for failures.

---

<sup>12</sup> Representatives from Enbridge, Inc., and TransCanada Pipeline Company were invited to make presentations to the committee during its first meeting on July 23, 2012. During the public meeting, the representatives were asked to identify any special operational or maintenance demands associated with transporting diluted bitumen. None was identified. On October 9–10, 2012, committee members convened a public meeting in Edmonton, Alberta, in which representatives of several pipeline companies that transport diluted bitumen were interviewed. In conjunction with the meeting, committee members also visited a transmission pipeline terminal in Fort McMurray, Alberta, where representatives from the pipeline company explained operational and control procedures associated with diluted bitumen transportation. They also responded to questions from committee members. None of the interviews and information obtained from the site visit suggested that operators use different procedures for system control and monitoring when they transport diluted bitumen.



As with other potential issues, the absence of significant differences in the chemical and physical properties of diluted bitumen compared with other heavy crude oils suggests that no changes are required in pipeline maintenance and inspection regimes. Nevertheless, the committee searched for reports of operators experiencing difficulties in carrying out standard maintenance, mitigation, and inspection activities while transporting diluted bitumen. The committee also searched for standards and other guidance documentation alerting operators to issues associated with maintenance and inspection, such as advisories on the use of in-line inspection tools, chemical inhibitors, and coupons and probes for corrosion monitoring. The search did not uncover any issues or added complexities.

In addition, in its questionnaire to Canadian pipeline operators (see Appendix A), the committee asked whether the transportation of diluted bitumen required changes in pipeline cleaning intervals or predictive and preventive maintenance programs. No differences in cleaning intervals or predictive and preventive maintenance programs were reported. Pipeline operators who met with the committee during public meetings (as noted above) were asked similar questions, and all stated that no special maintenance and inspection issues arose in transporting diluted bitumen. They did not report any adverse affects on their ability to carry out their normal maintenance and inspection activities.

#### **Assessment of Effects of Diluted Bitumen on O&M Procedures**

As common carriers, operators of transmission pipelines generally have the ability to transport the wide range of crude oil varieties that are in the commercial stream. Accordingly, operations and maintenance procedures are designed to be robust, capable of ensuring operational reliability and safety without the need for significant procedural modifications from one crude oil shipment to the next. The chemical and physical properties of diluted bitumen do not suggest that transporting this product by pipeline requires O&M procedures that differ from those of other crude oils having similar properties. Likewise, inquiries with operators and searches of industry guidelines and advisories did not indicate any specific issues associated with transporting diluted bitumen that would negatively affect operators as they carry out their standard O&M programs, including their corrosion detection and control capabilities.

#### **SUMMARY**

The chemical and physical properties of diluted bitumen shipments have been examined to determine whether there are any differences from those of other crude oil shipments that increase the likelihood of pipeline failures from internal degradation, external degradation, or mechanical damage. Any differences that could affect either the frequency or the severity of a failure mechanism or the ability to mitigate it would suggest a difference in failure likelihood. The chemical and physical properties of diluted bitumen shipments were not found to differ in ways that would be expected to create a likelihood of release that is higher for a transmission pipeline transporting diluted bitumen than one transporting other crude oils. An assessment was also made with regard to whether pipeline operators transporting diluted bitumen alter their O&M procedures in ways that can inadvertently make pipelines more prone to the sources of failure. No differences were found in these procedures. The assessment results are summarized in the next chapter.

## REFERENCES

## Abbreviations

CEPA	Canadian Energy Pipeline Association
NTSB	National Transportation Safety Board

- Aktas, D. F., J. S. Lee, B. J. Little, K. E. Duncan, B. M. Perez-Ibarra, and J. M. Suflita. 2013. Effects of Oxygen on Biodegradation of Fuels in a Corroding Environment. *International Biodeterioration and Biodegradation*, Vol. 81, July, pp. 114–126.
- Atlas, R. M. 1981. Microbial Degradation of Petroleum Hydrocarbons: An Environmental Perspective. *Microbiological Reviews*, Vol. 45, No. 1, pp. 180–209.
- Beavers, J. A., and N. G. Thompson. 2006. External Corrosion of Oil and Natural Gas Pipelines. *ASM Handbook, Vol. 13C, Corrosion: Environments and Industries*, pp. 1015–1025. <http://www.asminternational.org/content/ASM/StoreFiles/ACFAB96.pdf>.
- CEPA. 2007. *Stress Corrosion Cracking: Recommended Practices*, 2nd ed. Calgary, Alberta, Canada.
- Ciaraldi, S. W., H. H. Ghazal, T. A. Shadey, H. A. El-Leil, and S. El-Raghy. 1999. Progress in Combating Microbiologically Induced Corrosion in Oil Production. Paper 181. Presented at Corrosion 99, National Association of Corrosion Engineers International, Houston, Tex.
- Das, N., and P. Chandran. 2011. Microbial Degradation of Petroleum Hydrocarbon Contaminants: An Overview. SAGE-Hindawi Access to Research, *Biotechnology Research International*, Vol. 2011, Article ID 941810.
- DeWaard, C., and D. E. Milliams. 1975. Carbonic Acid Corrosion of Steel. *Corrosion*, Vol. 31, No. 5, pp. 171–181.
- El-Raghy, S. M., B. Wood, H. Abuleil, R. Weare, and M. Saleh. 1998. Microbiologically Influenced Corrosion in Mature Oil Fields—A Case Study of El-Morgan Field in the Gulf of Suez. Paper 279. Presented at Corrosion 98, National Association of Corrosion Engineers International, Houston, Tex.
- Escalante, E. 1989. Concepts of Underground Corrosion. In *STP 1013: Effects of Soil and Characteristics on Corrosion* (V. Chaker and J. D. Plamer, eds.), American Society for Testing and Materials International, Philadelphia, Pa., pp. 81–94.
- Friesen, W. I., S. Perovici, J. C. Donini, and R. W. Revie. 2012. Relative Corrosivities of Crude Oils from Oil Transmission Pipelines. Paper 2012-08. *Proc., 2012 Northern Area Eastern Conference: Corrosivity of Crude Oil Under Pipeline Operating Conditions*, National Association of Corrosion Engineers International, Houston, Tex.
- Hamilton, W. A. 2003. Microbiologically Influenced Corrosion as a Model System for the Study of Metal Microbe Interactions: A Unifying Electron Transfer Hypothesis. *Biofouling*, Vol. 19, No. 1, pp. 65–76.
- Hardy, J. A., and J. L. Bown. 1984. Corrosion of Mild Steel by Biogenic Sulfide Films Exposed to Air. *Corrosion*, Vol. 40, pp. 650–654.
- Jenneman, G. E., P. Wittenbach, J. Thaker, and Y. Wu. 1998. MIC in a Pipe Used for Disposal of Produced Water from a Coal Seam Gas Field. Paper 281. Presented at Corrosion 98, National Association of Corrosion Engineers International, Houston, Tex.
- Koch, G. H., M. P. H. Brongers, N. G. Thompson, Y. P. Virmani, and J. H. Payer. 2002. *Corrosion Cost and Prevention Strategies in the United States*. FHWA-RD-01-156. Office of Infrastructure Research and Development, Federal Highway Administration, March.
- Little, B. J., and J. S. Lee. 2007. *Microbiologically Influenced Corrosion*. John Wiley and Sons, Hoboken, N.J.
- Mora-Mendoza, J. L., R. Garcia-Esquivel, A. A. Padilla-Viveros, L. Martinez, O. F. Cedillo, C. A. Chavez, and M. M. Bautista. 2001. Study of Internal MIC in Pipelines of Sour Gas, Mixed with Formation Waters. Paper 01246. Presented at Corrosion 2001, National Association of Corrosion Engineers International, Houston, Tex.

- Mosher, M., B. Crozier, W. Mosher, J. Been, H. Tsapraillis, T. Place, and M. Holm. 2012. Development of Laboratory and Pilot Scale Facilities for the Evaluation of Sludge Corrosivity in Crude Oil Pipelines. Paper 2012-07. *Proc., 2012 Northern Area Eastern Conference: Corrosivity of Crude Oil Under Pipeline Operating Conditions*, National Association of Corrosion Engineers International, Houston, Tex.
- Nesic, S., S. Richter, W. Robbins, F. Ayello, P. Ajmera, and S. Yang. 2012. Crude Oil Chemistry on Inhibition of Corrosion and Phase Wetting. Paper 2012-16(c). *Proc., 2012 Northern Area Eastern Conference: Corrosivity of Crude Oil Under Pipeline Operating Conditions*, National Association of Corrosion Engineers International, Houston, Tex.
- NTSB. 2004. *Rupture of Enbridge Pipeline and Release of Crude Oil near Cohasset, Minnesota, July 4, 2002*. Report NTSB/PAR-04/01. Washington, D.C.
- NTSB. 2012. *Enbridge Incorporated Hazardous Liquid Pipeline Rupture and Release, Marshall, Michigan, July 25, 2010*. Report NTSB/PAR-12/01. Washington, D.C.  
<http://www.nts.gov/doclib/reports/2012/PAR1201.pdf>.
- Perry, J. J. 1984. Microbial Metabolism of Cyclic Alkanes. In *Petroleum Microbiology* (R. M. Atlas, ed.), Macmillan, New York, pp. 61–98.
- Pineda-Flores, G., and A. M. Mesta-Howard. 2001. Petroleum Asphaltene: Generated Problematic and Possible Biodegradation Mechanisms. *Revista Latinoamericana de Microbiologia*, Vol. 43, No. 3, pp. 143–150.
- Uhlig, H. H., and R. W. Revie. 1985. *Corrosion and Corrosion Control: An Introduction to Corrosion Science and Engineering*, 3rd ed. John Wiley and Sons, New York.
- Walker, J. D., and R. R. Colwell. 1975. Some Effects of Petroleum on Estuarine and Marine Microorganisms. *Canadian Journal of Microbiology*, Vol. 21, No. 3, pp. 305–313.
- Wikjord, A. G., T. E. Rummery, F. E. Doern, and D. G. Owen. 1980. Corrosion and Deposition During the Exposure of Carbon Steel to Hydrogen Sulfide Water Solutions. *Corrosion Science*, Vol. 20, No. 5, pp. 651–671.
- Zhang, A. G., and Y. F. Cheng. 2009. Micro-Electrochemical Characterization of Corrosion of Welded X70 Pipeline Steel in Near-Neutral pH Solution. *Corrosion Science*, Vol. 51, No. 8, pp. 1714–1724.
- Zhang, J. X., J. C. Fan, Y. J. Xie, and H. C. Wu. 2012. Research on Erosion of Metal Materials for High Pressure Pipelines. *Advanced Materials Research*, Vols. 482–484, pp. 1592–1595.

## Summary of Results

The study charge and approach and the main points from the preceding chapters are summarized in this chapter. The discussion summaries provide the basis for the findings presented at the end of the chapter.

### RECAP OF STUDY CHARGE AND APPROACH

Section 16 of the Pipeline Safety, Regulatory Certainty, and Job Creation Act of 2011 calls for the Secretary of Transportation to “complete a comprehensive review of hazardous liquid pipeline facility regulations to determine whether the regulations are sufficient to regulate pipeline facilities used for the transportation of diluted bitumen. In conducting the review, the Secretary shall conduct an analysis of whether any increase in the risk of a release exists for pipeline facilities transporting diluted bitumen.”<sup>1</sup> A determination of release risk requires an assessment of both the likelihood and the consequences of a release. To inform its assessment of the former, the U.S. Department of Transportation contracted with the National Research Council to convene an expert committee to “analyze whether transportation of diluted bitumen by transmission pipeline has an increased likelihood of release compared with pipeline transportation of other crude oils.”

As detailed in Chapter 1, the project statement of task calls for a two-phase study, with the conduct of the second phase contingent on the outcome of the first. In the first phase, the study committee was asked to examine whether shipments of diluted bitumen can affect transmission pipelines and their operations so as to increase the likelihood of release when compared with shipments of other crude oils transported by pipeline. In the potential second phase—to be undertaken only if a finding of increased likelihood of release is made in the first—the committee was asked to review federal pipeline safety regulations to determine whether they are sufficient to mitigate an increased likelihood of release from diluted bitumen. If the committee did not find an increased likelihood of release, or the information available was insufficient to make a finding, the committee was expected to prepare a final report documenting the study approach and results.

The committee reviewed data on reported pipeline releases. The review provided insight into the general causes of pipeline failures, but the incident records alone could not be used to determine whether pipelines are more likely to fail when they transport diluted bitumen than when they transport other crude oils. Having examined the general causes of failures, the committee focused on the specific sources of pipeline damage that can be influenced by the transported crude oil. Specifically, it identified the chemical and physical properties of crude oil that can cause or contribute to sources of pipeline failure from damage sustained internally or externally or as a result of mechanical forces.

The committee did not perform its own testing of pipelines or crude oil shipments. Information on the properties of shipments of diluted bitumen and other crude oils was obtained from public websites and assay sheets. Additional information was obtained from a review of

---

<sup>1</sup> Public Law 112-90, enacted January 3, 2012.

government reports and technical literature, queries of oil producers and pipeline operators, field visits, and inferences from secondary sources such as the maximum water and sediment content for pipeline shipments as specified in pipeline tariffs. The committee then compared the relevant properties of shipments of diluted bitumen with the range of properties observed in other crude oil shipments to identify instances in which diluted bitumen fell outside or at an extreme end of the range.

In view of the possibility that some pipeline operators may modify their operating and maintenance practices in transporting diluted bitumen, the committee first posited potential differences and then sought evidence. Operators were questioned about their practices. The committee looked for indications of changes in standard procedures, including corrosion control practices, that could inadvertently make pipelines more susceptible to sources of failure.

## **MAIN POINTS FROM CHAPTER DISCUSSIONS**

### **Crude Oil Pipeline Transportation in the United States**

As described in Chapter 2, the crude oil transmission network in the United States consists of an interconnected set of pipeline systems. Crude oil shipments traveling through the network often move from one pipeline system to another and are sometimes stored at terminals. Most operators of transmission systems are common carriers who do not own the crude oil they transport but provide transportation services for a fee. Few major transmission pipelines are dedicated to transporting specific grades or varieties of crude oil. They usually move multiple batches of crude oil, often provided by different shippers and encompassing a range of chemical and physical properties. Crude oil shipments are treated to meet the quality requirements of the pipeline operator as well as the content and quality demands of the refinery customer.

Pipeline systems traverse different terrains and can vary in specific design features, components, and configurations. The differences require that each operator tailor operating and maintenance strategies to fit the circumstances of its systems in accordance with the federal pipeline safety regulations. Nevertheless, the systems tend to share many of the same basic components and follow similar operating and maintenance procedures. Together, regulatory and industry standards, system connectivity, and economic demands compel both a commonality of practice and a shared capability of handling different crude oils.

### **Bitumen Properties, Production, and Pipeline Transportation**

As discussed in Chapter 3, the bitumen imported into the United States is derived from Canadian oil sands. Canadian bitumen is both mined and recovered in situ using thermally assisted techniques. A large share of the bitumen deposits is too deep for mining, so in situ recovery accounts for an increasing percentage of bitumen production. Because mined bitumen does not generally have qualities suitable for pipeline transportation and refinery feed, it is processed into synthetic crude oil in Canada. Bitumen recovered in situ with thermally assisted methods has lower water and sediment content and is thus better suited to long-distance transportation by pipeline than is mined bitumen. Bitumen imported into the United States is produced in situ through thermally assisted methods rather than by mining.

Like all forms of petroleum, Canadian bitumen is a by-product of decomposed organic materials and thus a mixture of many hydrocarbons. The bitumen contains a relatively large

concentration of asphaltenes that contribute to its high density and viscosity. At ambient temperatures, bitumen does not flow and must be diluted for transportation by unheated pipelines. Diluents consist of light oils, including natural gas condensate and light synthetic crude oils created from bitumen. Although the diluents consist of low-molecular-weight hydrocarbons, shipments of diluted bitumen do not contain a higher percentage of these light hydrocarbons than do other crude oil shipments. The dilution process yields a stable and fully mixed product for shipment by pipeline with density and viscosity levels in the range of other crude oils transported by pipeline in the United States.

Shipments of diluted bitumen are piped at operating temperatures, flow rates, and pressure settings typical of crude oils with similar density and viscosity levels. Shipment water and sediment content conforms to the Canadian tariff limits, which are more restrictive than those in U.S. pipeline tariffs. Solids in diluted bitumen shipments are comparable in quantity and size with solids in other crude oil shipments transported by pipeline. While the sulfur in diluted bitumen is at the high end of the range for crude oils, it is bound with hydrocarbons and not a source of corrosive hydrogen sulfide. Diluted bitumen has higher acid content than many other crude oils, but the stable organic acids that raise acidity levels are not corrosive at pipeline temperatures.

### **Review of Pipeline Incident Data**

A logical step in addressing the question of whether shipments of diluted have a greater propensity to cause pipeline releases than shipments of other crude oils is to examine historical release records. The incident statistics can be used to identify the general sources of pipeline failure. However, the information contained in the U.S. and Canadian incident records is insufficient to draw definitive conclusions. As explained in Chapter 4, one reason is that the causal categories in the databases lack the specificity needed to assess the particular ways in which transporting diluted bitumen can affect the susceptibility of pipelines to failure. Another reason is that incident records do not contain information on the types of crude oil transported and the properties of past shipments in the affected pipeline. Because many pipeline releases involve cumulative and time-dependent damage, there is no practical way to trace the transportation history of a damaged pipeline to assess the role played by each type of crude oil and its properties in transport.

Incident reporting systems in Canada and the United States do not have uniform reporting criteria and coverage. Given the relatively small number of pipeline incidents, even minor variations in reporting criteria can lead to significant differences in incident frequencies and causal patterns. Some reporting systems combine incident reports from oil gathering and transmission systems, while others do not. Variation in reporting coverage is problematic because gathering pipelines are fundamentally different from transmission pipelines in design, maintenance, and operations and in the quality and quantity of the liquids they carry.

### **Effects of Diluted Bitumen on Sources of Pipeline Damage**

The chemical and physical properties of diluted bitumen were examined in Chapter 5 to determine whether any differ sufficiently from those of other crude oils to increase the likelihood of pipeline failures from sources of damage internally or externally or from mechanical forces. Any differences that could affect either the frequency or severity of the failure mechanism or the ability to mitigate a potential failure mechanism would suggest a difference in failure likelihood.

No properties were found to differ in any way that may change the likelihood of pipeline damage and failure. An assessment was also made with regard to whether pipeline operators transporting diluted bitumen alter their operating and maintenance procedures in ways that can make pipelines more prone to the causes of failure the procedures are intended to prevent. No differences were found in these procedures. Summaries of the assessments are presented in Box 6-1.

Box 6-1

**Summary of Assessments of the Effects of Diluted Bitumen on Causes of Pipeline Damage**

**Internal Degradation**

A review of product properties pertaining to internal pipeline corrosion and erosion did not find that shipments of diluted bitumen are any more likely than shipments of other crude oils to cause these failure mechanisms. Shipments of diluted bitumen do not contain unusually high levels of water, sediment, dissolved gases, or other agents that can cause internal corrosion. The organic acids contained in diluted bitumen are not corrosive to steel at pipeline temperatures. The densities and viscosities of diluted bitumen shipments are within the range of other crude oils, and the velocity and turbulence with which shipments flow through pipelines are comparable and limit the formation of corrosive deposits. On the basis of an examination of the factors that influence microbial growth, diluted bitumen does not have a higher likelihood than other crude oils of causing microbiologically influenced corrosion. Because shipments of diluted bitumen have solids content and flow regimes comparable with those of other crude oil shipments, they do not differ in their propensity to cause erosion of transmission pipelines.

**External Degradation**

Pipelines can sustain external damage from corrosion and cracking. Because diluted bitumen only contacts the inside of a pipeline, it can contribute to external degradation only as a result of changes in pipeline operational parameters, specifically pipeline temperature and pressure levels. Elevated operating temperatures can increase the likelihood of external corrosion and cracking by causing or contributing to the degradation of protective coatings and by accelerating rates of certain degradation mechanisms. Elevated operating pressures can cause stress loadings and concentrations that lead to stress-related cracking, particularly at sites of corrosion and preexisting damage. Because the densities and viscosities of diluted bitumen are comparable with those of other crude oils, it is transported at comparable operating pressures and temperatures. For this reason, the likelihood of temperature- and pressure-related effects is indistinguishable for diluted bitumen and other crude oils of similar density and viscosity. Consequently, diluted bitumen will not create a higher propensity for external corrosion and cracking in transmission pipelines.

*(continued)*

**Box 6-1 (continued)****Mechanical Damage**

Mechanical damage to the pipeline and its components can occur as a result of overpressurization or outside forces. Mechanical forces can cause an immediate release or make the pipeline more susceptible to release by destabilizing support structures; damaging other components such as valves and joints; and weakening resistance to other failure mechanisms, such as corrosion attack. The study examined several possible causes of an increased potential for mechanical damage due to the properties of the transported liquid, including the potential for shipments of diluted bitumen to cause pressure surges or to interact with outside forces that can cause damage in pipelines. None of the properties or operating parameters of diluted bitumen shipments was found to be sufficiently different from those of other crude oils to suggest a higher potential to cause or exacerbate mechanical damage in pipelines.

**Effects on Operations and Maintenance Procedures**

As common carriers, operators of transmission pipelines generally have the ability to transport the wide range of crude oil varieties that are in the commercial stream. Accordingly, operations and maintenance procedures are designed to be robust, capable of ensuring operational reliability and safety without the need for procedural modifications from one crude oil shipment to the next. The chemical and physical properties of diluted bitumen shipments do not suggest that transporting them by pipeline requires operations and maintenance procedures that differ from those of other crude oil shipments having similar properties. Likewise, inquiries with operators and searches of industry guidelines and advisories did not indicate any specific issues associated with transporting diluted bitumen that would negatively affect operators as they carry out their standard operations and maintenance programs, including their corrosion detection and control capabilities.

**STUDY RESULTS****Central Findings**

*The committee does not find any causes of pipeline failure unique to the transportation of diluted bitumen. Furthermore, the committee does not find evidence of chemical or physical properties of diluted bitumen that are outside the range of other crude oils or any other aspect of its transportation by transmission pipeline that would make diluted bitumen more likely than other crude oils to cause releases.*

**Specific Findings**

*Diluted bitumen does not have unique or extreme properties that make it more likely than other crude oils to cause internal damage to transmission pipelines from corrosion or erosion. Diluted bitumen has density and viscosity ranges comparable with those of other crude oils. It is moved through pipelines in a manner similar to other crude oils with respect to flow rate, pressure, and*



operating temperature. The amount and size of solid particles in diluted bitumen are within the range of other crude oils so as not to create an increased propensity for deposition or erosion. Shipments of diluted bitumen do not contain higher concentrations of water, sediment, dissolved gases, or other agents that cause or exacerbate internal corrosion, including microbiologically influenced corrosion. The organic acids in diluted bitumen are not corrosive to steel at pipeline operating temperatures.

*Diluted bitumen does not have properties that make it more likely than other crude oils to cause damage to transmission pipelines from external corrosion and cracking or from mechanical forces.* The contents of a pipeline can contribute to external corrosion and cracking by causing or necessitating operations that raise the temperature of a pipeline, produce higher internal pressures, or cause more fluctuation in pressure. There is no evidence that operating temperatures and pressures are higher or more likely to fluctuate when pipelines transport diluted bitumen than when they transport other crude oils of similar density and viscosity. Furthermore, the transportation of diluted bitumen does not differ from that of other crude oils in ways that can lead to conditions that cause mechanical damage to pipelines.

*Pipeline operating and maintenance practices are the same for shipments of diluted bitumen and shipments of other crude oils.* Operating and maintenance practices are designed to accommodate the range of crude oils in transportation. The study did not find evidence indicating that pipeline operators change or would be expected to change such practices while transporting diluted bitumen.

These study results do not suggest that diluted bitumen will experience pipeline releases at a rate that is higher than its proportion of the crude oil stream. Future pipeline releases can be expected to occur, and some will involve diluted bitumen. All pipeline releases can be consequential. As explained at the outset of this report, the committee was not asked or constituted to study whether pipeline releases of diluted bitumen and other crude oils differ in their consequences or to determine whether such a study is warranted. Accordingly, the report does not address these questions and should not be construed as having answered them.

## APPENDIX A

### Questionnaire to Pipeline Operators on Transporting Diluted Bitumen

*The following questions were developed by the committee and given to the Canadian Energy Pipeline Association (CEPA) in January 2013. CEPA distributed the questionnaire to member pipeline companies and returned the results in March 2013. Operator responses are indicated in bold text.<sup>1</sup>*

1. Please provide the following information:
  - a. Total amount of transmission crude oil pipeline mileage: **Approximately 24,000**
  - b. Mileage dedicated to dilbit service: **Approximately 890**
  - c. Mileage in batch service: **Approximately 20,530**
  - d. Percentage of barrels transported per day consisting of diluted bitumen:
    - Operator A: 82 percent**
    - Operator B: 15 to 65 percent**
    - Operator C: 65 percent**
    - Operator D: 65 percent**
    - Operator E: 28 percent dilbit; 3 percent synbit**
  
2. Please provide the following parameters on the properties of diluted bitumen measured at points of custody transfer or in-line (as appropriate and available):

**Table A-1 includes information gathered on a best-effort basis. One operator also reported some data for synbit, and these data were included for reference. In addition, H<sub>2</sub>S data for a large number of crude oils are available from a study performed by Omnicon supported by several pipeline operators. These data were collected by using ASTM D5263 and have been included below for reference (see Figure A-1).**
  
3. How often (e.g., percentage of barrels transported) is specified basic water and sediment (BS&W) exceeded at diluted bitumen initial custody transfer?

**For dilbit batches, between 0 and 0.6 percent of the barrels transported exceeded specified limits.**
  
4. Is BS&W exceeded more often for diluted bitumen compared with other crude oils transported?

**Three operators reported no differences. In two cases, dilbit batches did exceed specified limits more often than other crude oils by a small margin of between 0.1 and 0.3 percent.**

---

<sup>1</sup> API = American Petroleum Institute; CO<sub>2</sub> = carbon dioxide; H<sub>2</sub>S = hydrogen sulfide; KOH = potassium hydroxide; O<sub>2</sub> = oxygen; ppm = parts per million; ppmw = parts per million by weight; psi = pounds per square inch; TAN = total acid number.

TABLE A-1 Operator Responses to Question 2

Parameter	Operator	Average	Normal Range	Extreme High
Total BS&W (volume percentage)	A	0.35	0.25 to 0.40	0.5
	B	0.21	0.05 to 0.36	0.36
	C	0.18	0.11 to 0.25	0.5
	D	0.26	0.05 to 0.5	0.5
	E (dilbit)	0.28	0.1 to 0.38	0.5
	E (synbit)	0.31	0.28 to 0.34	0.5
Water share of BS&W	C	50 percent	40 to 60 percent	100 percent
Sediment share of BS&W	C	50 percent	40 to 60 percent	100 percent
Solid content (ppmw)	B		0 to 0.01	
Solids particle size (microns)	Not routinely measured in crude oil			
H <sub>2</sub> S (ppmw)	B	6.77	0.1 to 11.1	11.1
	C	<0.5		10
	E	<0.5	<0.5	
Carbon dioxide (ppm)	Not routinely measured in crude oil			
Oxygen (ppm)	Not routinely measured in crude oil			
Sulfur (weight percentage)	A	3.8	3.62 to 3.85	
	B	3.3	2.45 to 4.76	4.8
	C	3.8	3.79 to 3.89	4.0
	D	3.7	3.0 to 4.1	4.1
	E (dilbit)	4.0	3.46 to 4.97	5.2
	E (synbit)	3.1	3.04 to 3.21	3.5
API gravity	A	21.5	19.0 to 23.1	
	B	20.6	19.3 to 21.3	
	C	22.1	21.4 to 22.2	
	D	21	19.0 to 23.3	
	E (dilbit)	21.5	20.3 to 21.9	
	E (synbit)	19.8	19.5 to 20.1	
Reid vapor pressure (psi)	B	5.1	2.54 to 7.58	7.58
	C	7		
	D	8	3 to 11.8	11.8
	E (dilbit)	7.3	5.85 to 7.79	14.9
	E (synbit)	3.1	2.4 to 3.0	14.9
	TAN (mg KOH/g)	A	1	0.85 to 1.05
B		1.6	1.0 to 2.17	3.34
C		1.6	1.52 to 1.64	1.82
D		1.06	0.6 to 1.9	1.9
E (dilbit)		1.3	0.92 to 2.49	3.75
E (synbit)		1.6	1.4 to 2.22	2.5

(continued)

TABLE A-1 (continued) Operator Responses to Question 2

Parameter	Operator	Average	Normal Range	Extreme High
Transport temperature (°C), transmission pipelines	A	30	26 to 34	40
	B	10 (winter); 22 (summer)	4 to 29	32
	C	15	5 to 35	50
	D	27	13 to 43	43
	E	17	9.5 to 22.7	25.4
Flow rate (ft/s) in transmission pipelines	A	4	2.0 to 6.0	
	B	6.56	4.5 to 7.2	8.2
	C	2.5	0.5 to 4.7	5.0
	D	6.7	4.8 to 8.2	8.2
	E	3.63	3.63	4.04
Pressure (psi) in transmission pipelines	A	930	700 to 1,200	1,300
	B	600	43.5 to 1,160	1,440
	C	500	175 to 1,350	1,440
	D	430	50 to 1,440	1,440
	E	750	750	1,095

5. Do tank storage methods for diluted bitumen differ from those of other crudes to possibly affect level of O<sub>2</sub>, CO<sub>2</sub>, water, and other contaminants?  
**No, the storage method is the same as for all crude oil commodities. Dilbits are generally stored in their own commodity group to reduce downgrading.**
6. Note any differences in set points for safety and control instrumentation for pipelines in diluted bitumen service as opposed to lines in other service:  
**There are no differences. Standards and procedures are in place for control that are generic for all crude oil commodities shipped. The standards and procedures are structured to ensure safe operation regardless of the commodity.**
7. Note any differences in the frequency of shutdowns, low-flow, and non-turbulent flow conditions while in diluted bitumen service:  
**There are typically no differences that are related to dilbit service. One operator reported a small increase of shutdown frequency due to BS&W exceedance.**
8. Note any special surge control equipment and/or vibration monitors on pipelines that carry diluted bitumen:  
**No special equipment has been installed specifically to accommodate dilbit.**
9. Are drag reducing agents used for diluted bitumen transportation?  
 If so, does their use differ (more or less?) compared with other crude types?  
**Three of five operators are currently not using drag-reducing agents for dilbit transportation. The use of drag-reducing agents is not specific to dilbit transportation. Their use is based on the operational requirements of a particular pipeline segment and throughput required.**

10. Do pipelines undergo more pressure cycling when in diluted bitumen service?  
**The operating philosophy and function of a pipeline drive pressure cycling, not the type of product transported. Batching between heavy and light products in the same pipeline may cause additional cycling; however, this is related to the switch in products rather than the products themselves. One operator reported that dilbit service lines cycle less frequently than those in conventional crude oil service.**
11. Are pressure cycles measured and monitored for use in fatigue calculations?  
**Three of five operators currently monitor and use pressure cycles in fatigue calculations, and one operator is planning to complete this activity in the future. One operator does not currently complete this activity.**
12. Are corrosion inhibitors, including biocides, used for diluted bitumen shipments?  
If so, do quantities differ from those used for other crude types?  
**Three of the operators use chemical treatment for bacteria or corrosion control in at least some of their pipelines. Chemical treatment requirement is determined by the flow conditions and pipeline condition. When such treatments are required, the volume and quantities are the same as for other crude oil pipelines.**
13. Is cleaning required at different intervals for pipelines in diluted bitumen service versus pipelines in other service?  
**The requirement for a cleaning program and cleaning intervals are primarily determined by consideration of flow conditions and the potential for water and sediment deposition for all crude oil types. No differences in cleaning intervals were reported by any operator.**
14. Is the debris from pig cleaning analyzed?  
If so, note any differences in composition for pipelines in diluted bitumen service?  
**Four of five operators complete testing of debris from pig cleaning, and no differences in composition have been reported for pipelines in dilbit service versus other heavy commodity pipelines. For pipelines in batch service with multiple products including dilbit, it is not possible to differentiate the sediment collected.**
15. Is there any evidence from in-line inspection and/or other corrosion monitoring activities indicating unusual or unexpected corrosion locations for lines in diluted bitumen service?  
**Corrosion in heavy-oil pipelines can occur in areas where water or sediment accumulates—including low areas, critical inclines, and overbends. The latter location was unexpected when it was identified in 2005, but this does not appear to be unique to dilbit pipelines and is common to heavy commodities in general. No unusual or unexpected corrosion locations have been attributed to dilbit service.**
16. Note any difference in clogging or wear of equipment, such as pumps, for lines in diluted bitumen service:  
**No clogging or unusual wear has been identified for lines in dilbit service.**

17. Note any differences in predictive/preventive maintenance practices for lines in dilbit service:  
**No special predictive or preventive maintenance practices are required for dilbit pipelines.**
18. More generally, do you have integrity management programs specific to lines in dilbit service?  
**No, dilbit lines are incorporated into overall integrity management programs. In more than 25 years of diluted bitumen service on some pipelines, no unique or more severe threats specific to diluted bitumen service have been observed.**

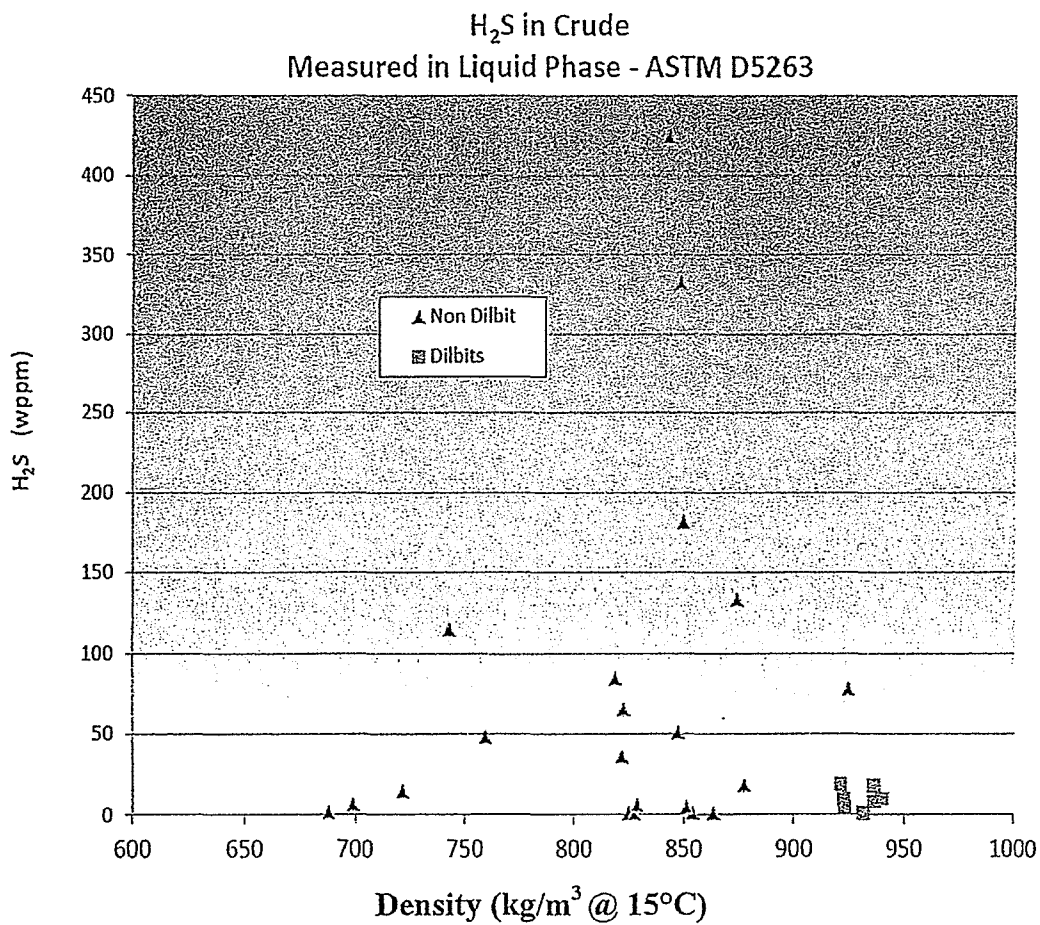

FIGURE A-1 Supplemental information on H<sub>2</sub>S content.

## APPENDIX B

### Federal Pipeline Safety Regulatory Framework

#### ORIGINS OF HAZARDOUS LIQUIDS PIPELINE SAFETY REGULATION

The Hazardous Liquid Pipeline Safety Act (HLPSA) of 1979, as amended, provides the statutory authority for the U.S. Department of Transportation (USDOT) to establish regulatory standards for the transportation of hazardous liquid by pipelines, including those transporting crude oil.<sup>1</sup> Within the department, authority to carry out the act is delegated to the Pipeline and Hazardous Materials Safety Administration (PHMSA), which implements its authority through the Office of Pipeline Safety (OPS). OPS promulgates rules governing the design, construction, testing, inspection, maintenance, and operations of hazardous liquid pipelines. The regulations are intended to establish minimum safety standards applicable to all hazardous liquid pipeline facilities, thereby setting a safety floor that all operators must meet across the spectrum of pipeline systems. The regulations cover pipelines that transport crude as well as refined products.

A review of past OPS rulemaking notices reveals that as the regulatory program evolved and matured, USDOT and Congress began to question whether the regulatory program was having sufficient effect in reducing the risk of transporting hazardous liquid by pipeline. A central concern was that individual pipeline operators could be complying with each of the actions prescribed in the federal rules in a procedural, or “checklist,” manner without really knowing whether these actions were collectively producing the desired safety assurance. Because pipeline facilities vary in their designs, construction, environments, and operating histories, specific safety assurance methods—including those not prescribed in federal rules—might be more suitable for one facility than for another. Moreover, OPS had long been concerned that it could not identify all facility-specific risks, which made a strictly prescriptive approach to safety regulation impractical. The changes made in response to these concerns have led to changes in the role of OPS and to new expectations for safety assurance by the pipeline industry.

#### PRESCRIPTIVE AND PERFORMANCE-BASED STANDARDS

After several major pipeline releases during the late 1980s and early 1990s, OPS started experimenting with other regulatory approaches to accompany its rules, which prescribed such specific actions as maintaining operating pressure at levels not to exceed 72 percent of specified minimum yield strength (SMYS).<sup>2</sup> The agency sponsored a series of demonstration projects that gave operators the incentive and flexibility to tailor their safety assurance methods to their specific circumstances. OPS reasoned that because pipeline operators have the most comprehensive and detailed knowledge of their systems, they are in the best position to devise their safety assurance programs, as long as they are given the motivation, tools, and regulatory flexibility to make effective choices.<sup>3</sup>

---

<sup>1</sup> Rulemaking to begin implementation of HLPSA began in 1981 (*Federal Register*, Vol. 46, No. 143, July 27, 1981) and can be found at <http://phmsa.dot.gov/staticfiles/PHMSA/hrmpdfs/1981%20hist%20rulemakings/46%20FR%2038357.pdf>.

<sup>2</sup> §195.406.

<sup>3</sup> See *Federal Register*, Vol. 65, No. 237, Dec. 8, 2000.

In 2000, OPS issued a landmark rulemaking titled Pipeline Integrity Management in High Consequence Areas.<sup>4</sup> Rather than prescribing specific operations and maintenance procedures, new rules laid out the key steps to be followed in developing and implementing a rationalized integrity management program based on principles of risk management. The regulations defined the core elements of the required program, such as the development of a written plan explaining how risks are to be identified; the logic used in choosing the tools, methods, and schedules employed for detecting and assessing risks; and the timetable for completing risk assessments and correcting deficiencies. The rules were written in performance-based language that does not tell operators exactly how they must conduct the risk assessments or precisely how they must act to mitigate identified risks. For example, if internal corrosion is identified as a threat in a particular pipeline segment, the operator is held responsible for selecting the best means to mitigate it—by using corrosion inhibitors, increasing the frequency of line cleaning, shortening inspection intervals, or selecting other defensible options.

Although performance-based rules have the advantage of allowing customized responses to specific circumstances, they can at times lack the clarity of a specific measure prescribed in rules applicable to all.<sup>5</sup> Accordingly, OPS has retained many of its prescriptive rules and continues to adopt new ones, depending on the safety concern. Box B-I outlines the basic set of rules governing the transportation of hazardous liquids by pipeline, as contained in the Code of Federal Regulations, Title 49, Part 195. Examples of prescriptive rules, in addition to the aforementioned standard for maximum operating pressure, are those concerning pipeline design and construction features, such as the requirement for shutoff valves located at each side of a water crossing.<sup>6</sup> Nevertheless, in instances where alternatives to prescribed measures have safety merit, the operator can seek a waiver, or special permit, from OPS by demonstrating that the alternative measures will yield the same or higher levels of safety than the prescribed ones.<sup>7</sup>

An example of a special permit application is the original plan of TransCanada Corporation to construct the Keystone XL pipeline. When the pipeline was first proposed in 2008, the company petitioned OPS to allow for maximum operating pressures of 80 percent of SMYS. OPS agreed to the special permit conditioned on TransCanada Corporation implementing 57 measures not currently delineated in the regulations and on adding a degree of rigor not currently required. The conditions covered, among other things, quality control checks during the manufacture and coating of the pipe, tighter valve spacing, remote control valves, monitoring and control of operating temperatures, more frequent pig cleaning, and specific limits on the levels of water and sediment contained in the products transported. Although TransCanada Corporation eventually withdrew the special permit application, it agreed to comply with the 57 conditions as part of its separate presidential application to build and operate a pipeline that crosses a national border.<sup>8</sup>

<sup>4</sup> See *Federal Register*, Vol. 65, No. 237, Dec. 8, 2000.

<sup>5</sup> For example, the National Transportation Safety Board recently urged PHMSA to revise the integrity management–high consequence area rule to better define when an assessment of environmental cracks must be performed, acceptable engineering methods for such assessments, and specific treatments that must be applied when cracks are found. <http://www.ecfr.gov/cgi-bin/text-idx?c=ecfr&SID=4c83a26cf5fcbaf90e350dddcff30166&rgn=div8&view=text&node=49:3.1.1.1.1.1.6.22.28&idno=49.195.260>.

<sup>6</sup> §195.260.

<sup>7</sup> These are general regulations also pertaining to natural gas pipelines and are thus contained in 49 CFR Part 190.

<sup>8</sup> In 2008, TransCanada Corporation proposed the addition of a new hazardous liquid transmission pipeline, called the Keystone XL, which would originate in Alberta and terminate in Steele City, Nebraska. Because the pipeline crossed the U.S. border, it required presidential approval. Public Law 112-78 required the president to act on the application within 60 days of the law's enactment on December 23, 2011. In early 2012, President Barack Obama denied the application, citing a review by the U.S. Department of State that expressed the need for more information to consider relevant environmental issues and the



Finally, in addition to having special permit authority, OPS has broad authority in the name of public safety to demand that pipeline operators take certain actions not specifically called for in regulations. For example, if the agency discovers a hazardous condition, it can issue orders requiring operators to take certain responsive or precautionary measures.<sup>9</sup> On discovering a condition that may be of concern to multiple pipelines, OPS can issue advisory bulletins that notify operators about the condition and how it should be corrected.

## SUPPORTIVE PROGRAMS

The emphasis on risk- and performance-based standards has not only affected OPS rulemaking activity but also changed other aspects of its safety oversight program. Where it does not prescribe specific safety actions or practices, OPS seeks to ensure that operators are in compliance with the performance-oriented demands outlined in the regulations. Aided by its inspection and enforcement capabilities, OPS will verify that pipeline operators are developing and implementing risk management programs that have a rigorous and technically sound basis. A checklist compliance inspection approach is not considered adequate. Inspecting for compliance under these circumstances requires an approach more akin to a quality assurance audit to ensure that operators are following a well-defined set of actions. In addition, the advent of performance-based regulations has meant that OPS safety researchers now have responsibility for providing technical guidance to aid operators in developing rigorous risk management programs, including development of the requisite analytic tools.

About half of the 200-person OPS staff is responsible for inspecting pipeline facilities, with assistance from more than 300 state inspectors. Inspectors are authorized to review the manual for operations and maintenance required of each operator. Inspectors also review records documenting the evaluations that have been performed to identify and prioritize risk factors, devise integrity management strategies, and prioritize the preventive and mitigative measures. If OPS has reason to believe that a specific risk factor is escaping the scrutiny of a pipeline operator, it can review company records to determine whether and how the risk is being treated. As described in Chapter 4, PHMSA also requires operators to report incidents involving releases from pipelines. The agency uses the reports to guide its regulatory, inspection, and enforcement priorities.

Through its research and engineering capacity, OPS can assist pipeline operators in complying with both prescriptive and performance-based rules. In 2012, the agency funded about \$7 million in research, with most projects conducted in collaboration with industry through cooperative programs such as the Pipeline Research Council International, Inc. Much of the research is designed to help operators comply with regulatory demands; for example, by developing tools and methodologies to detect and map pipeline leaks, locate and diagnose faults in cathodic protection systems, inspect lines that cannot be pigged, and conduct risk analyses. Research projects are also designed to provide technical support for industry standard-setting activities; for example, by evaluating new test methods being considered by standards development committees.

---

consequences of the project on energy security, the economy, and foreign policy (*Federal Register*, Vol. 77, No. 23, Feb. 3, 2012, p. 5614).

<sup>9</sup> 49 CFR §190.

## Box B-1

**Summary of Coverage of Federal Hazardous  
Liquid Pipeline Safety Regulations**  
*Title 49, Part 195—Transportation of Hazardous Liquids by Pipeline*

**Subpart A—General**

§195.0 to  
§195.12

Regulation coverage, definitions, incorporations by reference of consensus standards, and compliance responsibility.

**Subpart B—Reporting**

§195.48 to  
§195.64

Includes reporting requirements for accidents and safety-related conditions as well as requirements for operators to provide assistance during investigations.

**Subpart C—Design**

§195.100 to  
§195.134

Includes pipe and component design requirements governing design temperature, internal design pressure, external pressure and loads, valves and fittings, closures and connections, and station pipe and breakout tanks.

**Subpart D—Construction**

§195.200 to  
§195.266

Includes construction-related requirements governing material inspection, transportation of pipe, location of pipe, installation and coverage of pipe, welding procedures and welder qualifications, weld testing and inspection, valve location, pumping stations, and crossings of railroads and highways.

**Subpart E—Pressure Testing**

§195.300 to  
§195.310

Includes requirements governing pressure testing of pipe, components, tie-ins, and breakout tanks. Also contains requirements for risk-based alternatives to pressure testing of older pipelines.

**Subpart F—Operations and Maintenance**

§195.400 to  
§195.452

Includes requirements for an operations, maintenance, and emergency response manual; maximum operating pressure; inspections of breakout tanks and rights-of-way; valve maintenance; pipe repairs; line markers and signs; public awareness and damage prevention programs; leak detection and control room management; and integrity management in high-consequence areas.

(continued)

**Box B-1 (continued)****Subpart G—Qualification of Pipeline Personnel**

§195.501 to      Requirements for qualification programs and record  
§195.509      keeping.

**Subpart H—Corrosion Control**

§195.551 to      Includes regulations on coatings for external  
§195.589      corrosion control, coating inspection, cathodic  
                         protection and test leads, inspection of exposed pipe,  
                         protections from internal corrosion, protections  
                         against atmospheric corrosion, and assessment of  
                         corroded pipe.

**Appendix A**      Delineates federal and state jurisdiction.

**Appendix B**      Risk-based alternative to pressure testing older  
                         pipelines.

**Appendix C**      Guidance for integrity management program  
                         implementation.

## APPENDIX C

### Data-Gathering Sessions

#### Committee for a Study of Pipeline Transportation of Diluted Bitumen

First Meeting  
July 23–24, 2012  
Washington, D.C.

July 23

- 9:45 a.m. Briefing by study sponsor, Pipeline and Hazardous Materials Safety Administration (PHMSA)  
Linda Daugherty, Deputy Associate Administrator for Policy and Programs  
Alan Mayberry, Deputy Associate Administrator of Field Operations  
Jeffery Gilliam, Senior Engineer and Project Manager
- Origins and scope of study
  - Overview of PHMSA's regulatory program
  - Agency data sources and technical reports
  - Additional background
- 11:30 a.m. Overview of relevant industry consensus standards and state of the practice in detecting, preventing, and mitigating internal corrosion of oil pipelines  
Oliver Moghissi, President, National Association of Corrosion Engineers (NACE), and Director, DNV Columbus, Inc
- 1:00 p.m. Alberta Innovates report, *Comparison of Corrosivity of Dilbit and Conventional Crude*  
John Zhou, Alberta Innovates Energy and Environment Solutions  
Harry Tsaprailis, Alberta Innovates Technology Futures
- 1:45 p.m. Industry associations  
Peter Lidiak, Director, Pipelines, American Petroleum Institute
- 2:30 p.m. Operator experiences—Enbridge Pipelines, Inc.  
Scott Ironside, Director, Integrity Programs
- 3:30 p.m. Operator experiences—TransCanada Corporation  
Bruce Dupuis, Program Manager, Liquid Pipeline Integrity  
Jenny Been, Corrosion Specialist, Pipe Integrity
- 4:15 p.m. Concerns raised in Natural Resources Defense Council (NRDC) report  
Anthony Swift, Attorney, International Program, NRDC

5:00 p.m. General discussion

5:45 Adjournment

July 24

9:35 a.m. National Energy Board (NEB)—Overview of Regulatory, Data, and Technical Activities  
Iain Colquhoun, Chief Engineer, NEB

10:15 a.m. Standard and Non-Standard Methodologies to Evaluate Crude Oil Corrosivity Under Pipeline Operating Conditions  
Sankara Papavinasam, Senior Research Scientist, CanmetMATERIALS

11:00 a.m. Public forum

12:15 p.m. Adjournment

#### **Subcommittee Meeting**

October 9, 2012

Edmonton, Alberta

8:40 a.m. Introductions: Enbridge Pipelines, Inc.; TransCanada; Inter Pipeline; Kinder Morgan; Crude Quality, Inc.

9:30 a.m. Experience with diluted bitumen quality and cleanliness when entering the pipeline system

10:45 a.m. Pipeline control and operations: diluted bitumen versus conventional crude oils

12:30 p.m. Integrity knowledge of pipelines  
Findings from inspecting pipelines in high consequence areas for anomalies

1:30 p.m. Other presentations

3:00 p.m. Tour of Natural Resources Canada, CanmetENERGY laboratory

**Second Committee Meeting**

October 23, 2012

Washington, D.C.

- 10:50 a.m. Overview of pipeline equipment, field operations, control center, leak detection, maintenance, regulation, and economics  
Thomas Miesner, Pipeline Knowledge and Development
- 1:30 p.m. Background on crude oils and diluted bitumen  
Harry Giles, Executive Director, Crude Oil Quality Association  
Randy Segato, Suncor Energy  
Andre Lemieux, Canadian Crude Quality Technical Association
- 2:30 p.m. Diluted bitumen: chemical and physical properties  
Heather Dettman, Natural Resources Canada, CanmetENERGY
- 3:30 p.m. Evidence from pipeline incident reporting systems  
PHMSA data: Jeffery Gilliam and Blaine Keener, PHMSA  
Pipeline Performance Tracking System: Peter Lidiak, American Petroleum Institute, and Cheryl Trench, Allegro Energy Consulting
- 4:30 p.m. Overview of PHMSA supplemental regulatory authorities to mitigate risk  
Jeffery Gilliam, PHMSA
- 5:00 p.m. Adjournment

**Third Committee Meeting**

January 31, 2013

Washington, D.C.

- 10:30 a.m. Summary of NACE conference proceedings on heavy oil and corrosion  
Sankara Papavinasam, Senior Research Scientist, Natural Resources Canada, CanmetMATERIALS
- 11:15 a.m. Operational experience transporting heavy crude oils by pipeline in California  
Art Diefenbach, Vice President of Engineering, Westpac Energy
- 1:00 p.m. Overview of federal hazardous liquid pipeline regulatory approach  
Jeffrey Wiese and Jeffery Gilliam, PHMSA
- 2:00 p.m. Changing patterns of crude oil supply and demand  
Geoffrey Houlton, Senior Director, Global Crude Oil Market Analysis, IHS
- 3:00 p.m. Adjournment

## Study Committee Biographical Information

**Mark A. Barteau**, *Chair*, is DTE Energy Professor of Advanced Energy Research, Professor of Chemical Engineering, and Director of the University of Michigan Energy Institute. Before accepting his appointments at the University of Michigan in 2012, he retired from the University of Delaware as Senior Vice Provost for Research and Strategic Initiatives and Robert L. Pigford Chair in Chemical Engineering. He was a National Science Foundation Postdoctoral Fellow at the Technische Universität München before joining the University of Delaware as Assistant Professor of Chemical Engineering and Associate Director of the Center for Catalytic Science and Technology in 1982. He became Director of the Center for Catalytic Science and Technology in 1996. He has held visiting appointments at the University of Pennsylvania and the University of Auckland, New Zealand. His research in surface chemistry and heterogeneous catalysis has been recognized with numerous awards, including the International Catalysis Award. He was the founding director of the University of Delaware Energy Institute. He is active in the National Research Council, serving as cochair of the Chemical Sciences Roundtable and as a member of the Chemical Engineering Peer Committee. He has also served on the Panel on Chemical Science and Technology, the Committee on the Review of Basic Energy Sciences Catalysis Program, and the Committee on Challenges for the Chemical Sciences in the 21st Century. He was elected to the National Academy of Engineering in 2006. He received a BS in chemical engineering from Washington University in St. Louis, Missouri, and an MS and a PhD in chemical engineering from Stanford University.

**Y. Frank Cheng** is Professor and Canada Research Chair in Pipeline Engineering in the Department of Mechanical and Manufacturing Engineering at the University of Calgary. His research has focused on pipeline corrosion, stress corrosion cracking, erosion–corrosion, coatings, metallurgical microelectrochemistry, and defect assessment. Before joining the faculty of the University of Calgary in 2005, he was a Natural Sciences and Engineering Research Council of Canada postdoctoral fellow at the Nova Research and Technology Center and a research scientist at the Center for Nuclear Energy Research at the University of New Brunswick. He is a member of the editorial board of *Corrosion Engineering, Science and Technology* and has published more than 120 articles in refereed journals on corrosion and pipeline engineering. He is the sole author of *Stress Corrosion Cracking of Pipelines*, published by Wiley. He is also Theme Editor of Pipeline Engineering for the *Encyclopedia of Life Support Systems* developed under the auspices of the United Nations Educational, Scientific, and Cultural Organization. He holds a BS in corrosion from Hunan University, an MS in materials engineering from the Institute of Metal Research from the Chinese Academy of Sciences, and a PhD in materials engineering from the University of Alberta.

**James F. Dante** is Manager of the Environmental Performance of Materials Section of the Southwest Research Institute. In this capacity, he supervises 15 staff engineers and technicians involved in basic and applied corrosion research for the energy industry and the U.S. Departments of Defense, Transportation, and Energy. Current programs include corrosion sensor research and implementation involving fluidized sensors, atmospheric corrosion sensors, and sensors for corrosion under insulation. His unit also conducts research on accelerated corrosion test methods and research to advance the mechanistic understanding of corrosion processes in

various industries. Before joining Southwest Research Institute in 2009, he was Senior Research Scientist at Luna Innovations and leader of the University of Dayton Research Institute's group specializing in corrosion mechanisms, detection, and protection. He began his career as a materials research engineer at the National Institute of Standards and Technology. He holds a BA in physics from Johns Hopkins University and an MS in materials science and engineering from the University of Virginia.

**H. Scott Fogler** is Vennema Professor of Chemical Engineering and Arthur F. Thurnau Professor at the University of Michigan. He is internationally recognized for his research and teaching in chemical reaction engineering in petroleum engineering, including reaction in porous media, fused chemical relations, kinetics of wax deposition, gelation kinetics, asphaltene deposition kinetics, remediation colloidal phenomena, and catalyzed dissolution. The Chemical Manufacturers Association honored him with the National Catalyst Award in 1999. He has published more than 200 articles in peer-reviewed journals and books. He is author of *Elements of Chemical Reaction Engineering*, which is in its fourth edition and is estimated to be used by three-quarters of all chemical engineering programs in the United States. He has received numerous awards from the American Society for Engineering Education, including the Dow Outstanding Young Faculty Award in 1972, the Corcoran Award for Best Paper in Chemical Engineering Education in 1993, and the Lifetime Achievement Award from the Chemical Engineering Division in 2005. He earned a BS in chemical engineering from the University of Illinois and an MS and a PhD in chemical engineering from the University of Colorado.

**O. B. Harris** is President of O. B. Harris, LLC, an independent consultancy specializing in the regulation, engineering, and planning of petroleum liquids pipelines. From 1995 to 2009, he was Vice President of Longhorn Partners Pipeline, LP, which operates a 700-mile pipeline that carries gasoline and diesel fuel from Gulf Coast refineries to El Paso, Texas. In this position, he was responsible for engineering, design, construction, and operation of the system. From 1991 to 1995, he was President of ARCO Transportation Alaska, Inc., a company owning four pipeline systems, including the Alyeska Pipeline Service Company, which transports 25 percent of the crude oil from the North Slope of Alaska to the Port of Valdez. From 1977 to 1990, he held several supervisory and managerial positions at ARCO Pipeline Company, including District Manager for Houston and Midland, Texas; Manager of the Northern Area; and Manager of Products Business. At ARCO Transportation, he directed the efforts of a team of corrosion engineers advising Alyeska on making repairs to the Trans-Alaska Pipeline System. He is a past member of the Board of Directors of the Association of Oil Pipe Lines and the Pipeline and Hazardous Materials Safety Administration's Technical Hazardous Liquids Pipeline Safety Standards Committee. He holds a bachelor's degree in civil engineering from the University of Texas and an MBA from Texas Southern University.

**Brenda J. Little** is Senior Scientist for Marine Molecular Processes in the Naval Research Laboratory (NRL) at the Stennis Space Center. Earlier she was a Supervisory Research Chemist, Principal Investigator in the Biological and Chemical Oceanography Branch, Supervisory Oceanographer, and Head of the Biological and Chemical Oceanography Branch. During her 35-year career at NRL, she has made major contributions in identifying and understanding microbiologically influenced corrosion of marine materials, which has had a significant impact on a broad spectrum of Navy applications. Her research has been used to prevent and mitigate



corrosion problems in seawater piping systems, fire protection systems, weapon cooling systems, helicopter interiors, and nuclear waste storage. She participated in a special U.S. Department of Transportation investigation of corrosion mechanisms in the Alaska North Slope pipeline. She is Assistant Editor of *Biofouling*, the *Journal of Bioadhesion*, and *Biofilm Research*. She coauthored (with J. S. Lee) *Microbiologically Influenced Corrosion* (John Wiley and Sons, 2007). She has published more than 80 journal articles, more than 100 papers in symposium proceedings, and more than 20 book chapters. Her publications have earned her numerous NRL publication awards. She is a Fellow of the National Association of Corrosion Engineers (NACE) and a recipient of the Navy Meritorious Civilian Service Award and Women in Science and Engineering Award for Scientific Achievement. She holds a BS in biochemistry from Baylor University and a PhD in chemistry from Tulane University.

**Mohammad Modarres** is Minta Martin Professor of Engineering and Professor of Nuclear and Reliability Engineering and Director of the Reliability Engineering Program at the University of Maryland, College Park. His research centers on probabilistic risk assessment; uncertainty analysis; and the physics of failure mechanisms of mechanical components, systems, and structures. He has served as a consultant to several governmental agencies, private organizations, and national laboratories in areas related to probabilistic risk assessment, especially applications to complex systems such as nuclear power plants and pipelines. He has authored more than 300 papers in archival journals and proceedings of conferences and three books in various areas of risk and reliability engineering. He is a member of several journal editorial boards, including the *Reliability Engineering and System Safety Journal*, *Journal of Risk and Reliability*, and *International Journal of Reliability and Safety*. He is Associate Editor of the *International Journal on Performability Engineering*. He holds a master's degree in mechanical engineering and a PhD in nuclear engineering, both from the Massachusetts Institute of Technology.

**W. Kent Muhlbauer** is Founder and President of WKM Consultancy, which provides consulting services on all aspects of pipeline design, operations, and maintenance with an emphasis on risk management. Clients include major U.S. and international pipeline operators, federal and state regulatory agencies, engineering companies, and insurance companies. Pipeline risk assessment techniques developed by WKM are in use by pipeline operating companies worldwide. Before forming WKM in 1995, he designed, constructed, and maintained pipeline systems for Dow Chemical's Pipeline Division. He held a variety of engineering and management positions starting in 1982, including operations engineer, technology center specialist, pipeline and salt dome storage quality manager, control center supervisor, and regional operations and maintenance manager. He is author of the *Pipeline Risk Management Manual* (Elsevier 1992, 1996, 2004) and author of numerous articles and papers on pipeline risk management. He is a frequent speaker and instructor at conferences, workshops, training sessions, and seminars on pipeline risk management and integrity preservation. He holds a BS in civil engineering from the University of Missouri.

**Srdjan Nešić** is Professor of Chemical Engineering and Director of the Institute for Corrosion and Multiphase Flow Technology at Ohio University. Before joining the faculty of Ohio University in 2002, he was a Senior Lecturer in the Mechanical Engineering Department of the University of Queensland, Brisbane, Australia; Principal Research Scientist at the Institute for Energy Technology, Kjeller, Norway; and Research Scientist at Vincha Institute for Nuclear

Sciences, Belgrade, Hungary. His expertise is in flow effects and erosion of pipelines, electrochemical corrosion, computational and experimental fluid dynamics, and multiphase flow. He has authored more than 50 peer-reviewed journal articles on these subjects and more than 100 conference papers. He is a Fellow of NACE and has chaired numerous NACE technical sessions and conferences on internal pipeline corrosion and erosion. He is a member of the editorial board of the *Corrosion Journal*. He holds bachelor's and master's degrees in mechanical engineering from the University of Belgrade and a PhD in chemical engineering from the University of Saskatchewan.

**Joe H. Payer** is Chief Scientist at the National Center for Education and Research on Corrosion and Materials Performance and Research Professor of Corrosion and Reliability Engineering at the University of Akron. In this position he directed the University Corrosion Collaboration for the U.S. Defense Department's Office of Corrosion Policy and Oversight. Before joining the University of Akron in 2009, he was Professor of Materials Science at Case Western Reserve University, where he directed the U.S. Department of Energy's multiuniversity Corrosion and Materials Performance Cooperative for improved performance assessment for long-term disposal of spent nuclear fuel. His expertise is in materials selection, failure analysis, corrosion control methods, monitoring systems, and degradation mechanisms. His research has focused on localized corrosion of highly corrosion-resistant materials, gas and oil pipeline integrity, the effects of manufacturing processes on the performance and reliability of materials in service, coatings and surface treatments, and hydrogen and materials interactions. He is a Fellow of the American Society for Metals International; a Fellow and Past President of NACE; and a recipient of the American Society for Testing and Materials Sam Tour Award for Distinguished Contributions to Research, Development, and Evaluation of Corrosion Testing Methods. He earned a BS and a PhD in metallurgical engineering from Ohio State University.

**Richard A. Rabinow** is President of the Rabinow Consortium, LLC, which provides economic and business consulting services to the pipeline industry. He retired from ExxonMobil after a 34-year career with the corporation. At the time of his retirement in 2002, he was President of ExxonMobil Pipeline Company (EMPCo), a position he had held at EMPCo and its predecessor, Exxon Pipeline Company, since 1996. Before that, he was Vice President and Lower 48 Manager of Exxon Pipeline Company. He began his career at the Exxon Company in 1968, where he held several engineering and supervisory positions in refineries. He rose to Executive Assistant to the President of Exxon Company, Baytown Refinery Manager, Manager of Corporate Affairs, Manager of the Environmental and Safety Department. He is a past Chairman of the Association of Oil Pipe Lines and the Owners Committee of the Trans-Alaska Pipeline System. He has served on the Transportation Research Board's Committee for Pipelines and Public Safety and the Committee on Alaska's Oil and Gas Pipeline Infrastructure. He received a BS in engineering mechanics from Lehigh University and MS degrees in mechanical engineering and management, both from the Massachusetts Institute of Technology.

**George W. Tenley, Jr.**, retired in 2010 as President of the Pipeline Research Council International (PRCI). PRCI is the collaborative research and development program for the energy pipeline industry. He joined PRCI in 1999 after working as an independent consultant on pipeline integrity planning and as a strategic advisor on pipeline risk management for Battelle Memorial Institute. From 1989 to 1995, he was Associate Administrator for Pipeline Safety in

the U.S. Department of Transportation. In this position, he was the senior federal official responsible for safety regulations governing the pipeline transportation of hazardous liquids and natural gases. From 1976 to 1989, he was a senior attorney and then Chief Counsel for the Research and Special Programs Administration. He began his career as an attorney for the Federal Aviation Administration and the Drug Enforcement Administration. He earned a BA in political science from the University of Maryland and a JD from the University of Maryland.

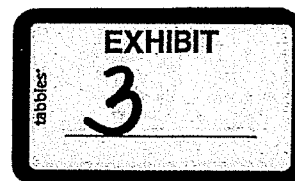

## Leukemia Risk Associated With Low-Level Benzene Exposure

Deborah C. Glass,\* Christopher N. Gray,<sup>†</sup> Damien J. Jolley,<sup>‡</sup> Carl Gibbons,<sup>‡</sup> Malcolm R. Sim,\*  
Lin Fritschi,<sup>§</sup> Geoffrey G. Adams,<sup>¶</sup> John A. Bisby,<sup>#</sup> and Richard Manuell<sup>#</sup>

**Background:** Men who were part of an Australian petroleum industry cohort had previously been found to have an excess of lympho-hematopoietic cancer. Occupational benzene exposure is a possible cause of this excess.

**Methods:** We conducted a case-control study of lympho-hematopoietic cancer nested within the existing cohort study to examine the role of benzene exposure. Cases identified between 1981 and 1999 (N = 79) were age-matched to 5 control subjects from the cohort. We estimated each subject's benzene exposure using occupational histories, local site-specific information, and an algorithm using Australian petroleum industry monitoring data.

**Results:** Matched analyses showed that the risk of leukemia was increased at cumulative exposures above 2 ppm-years and with intensity of exposure of highest exposed job over 0.8 ppm. Risk increased with higher exposures; for the 13 case-sets with greater than 8 ppm-years cumulative exposure, the odds ratio was 11.3 (95% confidence interval = 2.85-45.1). The risk of leukemia was not associated with start date or duration of employment. The association with type of workplace was explained by cumulative exposure. There is limited evidence that short-term high exposures carry more risk than the same amount of exposure spread over a longer period. The risks for acute nonlymphocytic leukemia and chronic lymphocytic leukemia were raised for the highest exposed

workers. No association was found between non-Hodgkin lymphoma or multiple myeloma and benzene exposure, nor between tobacco or alcohol consumption and any of the cancers.

**Conclusions:** We found an excess risk of leukemia associated with cumulative benzene exposures and benzene exposure intensities that were considerably lower than reported in previous studies. No evidence was found of a threshold cumulative exposure below which there was no risk.

**Key Words:** benzene, occupational exposure, leukemia, lymphoma, multiple myeloma, petroleum industry

(*Epidemiology* 2003;14: 569-577)

Benzene is present in crude oil, at most stages of petroleum production and distribution, and is a component of gasoline fuels, typically less than 3%. It is also a byproduct of combustion of fuels and other materials such as tobacco, wood, and coal. Benzene is present in indoor environments from activities such as cooking and heating, and it is ubiquitous in urban air at low concentrations. Nonsmokers living in an urban environment are typically exposed to average benzene concentrations in the order of 0.005 ppm.<sup>1</sup>

Benzene is classified as a group 1 human carcinogen by the International Agency for Research on Cancer,<sup>2</sup> and there is general agreement that benzene can cause leukemia in highly exposed individuals.<sup>3</sup> The extent of the risk of leukemia with exposure to low concentrations of benzene (less than 10 ppm) has been debated.<sup>3-11</sup> This debate has centered on 2 issues: whether the exposures were underestimated in previous epidemiologic studies and what model should be used to extrapolate the risk to lower concentrations of benzene, including whether there is a threshold exposure below which there is no risk.

In addition, there is debate about which subtypes of leukemia are associated with benzene exposure. Some but not all authorities consider that acute nonlymphocytic leukemias or, more specifically, acute myeloid leukemia, are the only subtypes clearly associated with benzene exposure.<sup>3,8,9,12,13</sup> Benzene has also been associated with increased risk of

Submitted 12 June 2002; final version accepted 30 May 2003.

From the \*Department of Epidemiology and Preventive Medicine, Central and Eastern Clinical School, The Alfred Hospital, Commercial Road, Melbourne, Victoria, Australia; the †Occupational Hygiene Unit, Faculty of Science and Technology, Deakin University, Geelong, Victoria, Australia; the ‡School of Health Sciences, Deakin University, Burwood, Victoria, Australia; the §School of Population Public Health, University of Western Australia, Crawley, Perth, Western Australia, Australia; the ¶School of Dental Science, The University of Melbourne, Melbourne, Victoria, Australia; and the #Department of General Practice and Public Health, The University of Melbourne, Carlton, Victoria, Australia.

This study was funded by the Australian Institute of Petroleum (AIP) and the Australian Energy Research and Development Corporation (ERDC).

Correspondence: Deborah C. Glass, Department of Epidemiology and Preventive Medicine, Central and Eastern Clinical School, The Alfred Hospital, Commercial Road, Melbourne, Victoria 3004, Australia. E-mail: deborah.glass@med.monash.edu.au.

Copyright © 2003 by Lippincott Williams & Wilkins  
1044-3983/03/1405-0569

DOI: 10.1097/01.ede.0000082001.05563.e0

multiple myeloma,<sup>3,14,15</sup> although this too is disputed.<sup>9,16</sup> A review of 308,000 benzene-exposed workers from 26 cohorts in 5 countries found no increased rate of non-Hodgkin lymphoma.<sup>17</sup> In the U.K., the occupational exposure limit for benzene (maximum exposure limit) is 3 ppm as an 8-hour time-weighted average.<sup>18</sup> This was introduced in 2000 as the first part of a phased reduction to 1 ppm in 2003 in accordance with the Carcinogens Directive of the Council of the European Union.<sup>19</sup> The current American Conference of Governmental Industrial Hygienists' threshold limit value for benzene is 0.5 ppm.<sup>20</sup>

A prospective cohort study of all-cause mortality and cancer incidence in the Australian petroleum industry, known as Health Watch, was established in 1980 at the University of Melbourne for the Australian Institute of Petroleum. In 1999 the study was transferred to the University of Adelaide. The cohort consists of all employees except head office staff and those employed at Australian sites with fewer than 10 employees. Employees in the industry have been surveyed at approximately 5-year intervals using an interviewer-administered job and health questionnaire. This questionnaire obtained information on jobs and tasks, on possible confounding variables (including smoking and alcohol), and on specific health outcomes. The first survey was conducted from 1981-1983 and resulted in an original cohort of 10,979 men and 626 women. More subjects were recruited in the second and subsequent surveys. Approximately 95% of eligible employees in the industry have participated in Health Watch surveys. Employees were recruited into the Health Watch cohort after having served 5 years in the petroleum industry, and they remain in the cohort for life. Copies of death certificates are obtained and cancer incidence is validated through state cancer registries and the treating doctor. Cancer registration in Australia is a legal requirement of pathology laboratories and hospitals. In 1998 the cohort comprised 15,732 men and 1178 women.

Men in the cohort have been shown to have increases in the standardized incidence ratios for leukemia of 2.0 (95% confidence interval [CI] = 1.3-2.9) and for multiple myeloma of 1.9 (95% CI = 1.0-3.3).<sup>21</sup> We designed a case-control study to assess the association between lympho-hematopoietic cancers and occupational benzene exposure among men in the cohort. We report the exposure-response relationships for lympho-hematopoietic cancers, including the subtypes of leukemia, and benzene exposure based on matched analyses.

## METHODS

This case-control study is nested within the Health Watch cohort. We estimated the occupational exposure to benzene of the cases and control subjects, drawing on the subject's entire job history and using measured exposures for a wide range of tasks in the petroleum industry.

Cases were defined as men in the Health Watch cohort who reported a newly diagnosed lympho-hematopoietic cancer to Health Watch (either by himself or by his family) that was confirmed by pathology report, cancer registration, letter from a medical practitioner, or death certificate. Registry cases who had not self-reported to Health Watch could be included under the terms of the ethics committee approval only if the man had been lost to follow up or had died.

Seventy-nine cohort members met the definition of lympho-hematopoietic cancer cases. They were identified by searching the cancer registries and through self-report to Health Watch. One man was found in the cancer registry, but under the terms of the ethics approval he could not be a case because he had not self-reported the disease and was not deceased or lost to contact.

All documentation on the cases was reviewed by the investigators and cases were assigned to International Classification of Diseases groupings according to the highest level of evidence (Table 1). For 9 cases with uncertain histology the documentation was reviewed by a hematologist who classified cases using the French-American-British system.<sup>22</sup>

We selected 5 male control subjects for each case. Control subjects were selected randomly from a list of all cohort members who were eligible at the time of diagnosis and matched by year of birth. As a result of the random selection, 5 workers were used as control subjects for more than 1 case, 4 of whom were used in 2 case-control sets and 1 in 3 sets. Thus, the total number of control subjects was 395. One worker selected as a control subject subsequently became a case; this subject was retained as a control subject because he was not diagnosed at the time of selection. As a control subject, his exposure was truncated at the time of the matched-case diagnosis (as with all control subjects). As a case his exposure was estimated up to the time of his diagnosis.

Each subject's smoking, alcohol, and job history had been collected as part of the Health Watch cohort surveillance.<sup>21</sup> For employees interviewed in either the first or second Health Watch surveys in 1981-1983 and 1986-1987, detailed information had been collected only on their current job and jobs held in the previous 5 years. During the third Health Watch survey in 1991-1993, full job histories were obtained for all current employees interviewed. For those Health Watch members no longer employed in the petroleum industry, lists of jobs held in the industry were obtained during the annual health check mail-out in 1994. The lists included job titles, company, site, area of work and dates, but no details of individual tasks or products handled. The job histories were cross-checked with company personnel records. In those instances in which discrepancies were found, the more detailed record (usually the subject's) was used.

TABLE 1. Type of Cancer by Highest Level of Evidence for the Diagnosis

Type of Lympho-hematopoietic Cancer	ICD-9 Code	Highest Level of Evidence				Total No. (N = 79)
		Histology (N = 39)	Doctors' Letters (N = 17)	Cancer Registry Alone (N = 14)	Death Certificate (N = 9)	
Non-Hodgkin lymphoma	200, 202	14	6	5	6	31
Multiple myeloma	203	8	4	2	1	15
Leukemia	204-208	17	7	7	2	33
Chronic lymphocytic leukemia	204.1	5	5	0	1	11
Chronic myeloid leukemia	205.1	1	1	4	0	6
Acute lymphocytic leukemia	204.0	2	0	0	0	2
Acute nonlymphocytic leukemia*	205.0, 208.0	7	1	2	1	11
Other leukemia†	202.4, 204.9	2	0	1	0	3

\*This group includes 9 acute myeloid leukemias and 2 acute undifferentiated leukemias.

†The 3 "other" leukemias were a hairy cell leukemia and 2 unspecified lymphocytic leukemias. ICD-9, World Health Organization International Classification of Diseases, 9th revision.

Cases were not themselves interviewed about their tasks, because this information might have been subject to recall bias. Instead, we interviewed contemporaries at the site who were familiar with the requirements of the job. These surrogate respondents provided information on the tasks that each subject would have performed for each job he had recorded in the job history, the technology used at that time, and products handled. Current and past employees were interviewed, and the interviews were structured using standard questionnaires for each job type based on those developed for previous petroleum industry epidemiologic studies.<sup>23,24</sup> The interviewers had no knowledge of the names and health status of the subjects.

We calculated the benzene exposure of each individual using a task-based algorithm involving the subject's occupational history; previously measured exposures for particular tasks in the Australian petroleum industry; and task-, site-, and period-specific data. This exposure model was similar to those used in some other petroleum industry epidemiologic studies<sup>23,24</sup> but more detailed in that it was task-based and applied to each individual's job history. This provided an estimate of cumulative exposure to benzene in parts per million-years (ppm-years) for each subject. The subjects were divided into geometric exposure groups. The exposure estimation process is described more fully elsewhere.<sup>25,26</sup>

We used the following additional exposure metrics to test the association with risk of leukemia, with and without adjustment for cumulative exposure:

1. Start date: Subjects were divided into 3 groups by their start date in the industry: pre-1965, 1965-1975, and post-1975.

2. Duration of employment: The duration of employment (in participating companies) was defined as the difference between the earliest start date and the latest finish date for each subject, truncated by date of diagnosis. We calculated quintiles of duration with cut-points approximately every 7 years.

3. Whether most of the career was spent as an office worker or as a blue collar worker.

4. Site of longest-held job and highest-exposed job: Each site where a subject worked was allocated to a site type. The period of time and associated exposure for each subject was then allocated to that site type. If a subject worked in the office at a refinery or a distribution terminal, he was included as an office worker rather than being assigned to a site type.

5. Intensity of exposure: We calculated the average exposure intensity (cumulative benzene exposure estimate divided by duration of employment) in ppm for each job. We divided the subjects into geometric exposure intensity groups based on their highest exposed job.

6. Subjects with exposure to benzene concentrate: We identified those subjects who had handled benzene concentrate that is 100% benzene or BTX (benzene-toluene-xylene, which is principally an aromatic fraction derived from coke oven operations, containing approximately 70% benzene).

All odds ratios and 95% confidence intervals are from matched analyses.

The study was carried out with the clearance of Monash University Standing Committee on Ethics in Research Involving Humans, and the Ethics Committees from Melbourne

and Adelaide Universities. All subjects signed a consent form to allow access to their job histories, and cases consented to our contacting their treating doctor for diagnostic details.

## RESULTS

The cases and control subjects were well matched demographically (Table 2). They were similar with regard to alcohol consumption and country of birth. Control subjects were slightly more likely than the cases to be exsmokers. The risk of leukemia was not associated with smoking; odds ratios (ORs) were 0.55 (95% CI = 0.18-1.32) for previous smokers and 1.28 (95% CI = 0.52-3.14) for current smokers compared with never-smokers. We estimated the OR for leukemia associated with smoking score (pack-years) and alcohol score (standard drink-years) both as continuous measures. The OR per 100 pack-years was 0.98 (95% CI = 0.80-1.19) and per 1000 drink-years was 0.78 (95% CI = 0.52-1.16).

The ages of the cases at the date of case diagnosis ranged from 26-79 years with a mean of 54 years (Table 2). The mean duration of employment, prior to diagnosis, was 20.4 years (standard deviation, 9.0 y), and ranged from 4.3-43 years. A control subject, employed for only 4.3 years at the time of diagnosis of the case to which he was matched, had satisfied the cohort criteria of being employed in the industry for 5 years or more.

Cases had, on average, a higher lifetime cumulative exposure than control subjects, and a greater proportion of cases were in higher exposure categories (Table 3). The subjects were grouped by cumulative exposure (ppm-years) into 6 geometric groups, and conditional logistic regression

(case-matched) was used to calculate stratum-specific ORs (Table 4). No increase in risk for non-Hodgkin lymphoma/multiple myeloma was found with increasing exposure to benzene. However, the ORs for leukemia were found to be elevated for 3 of the 5 exposure groups compared with the lowest ( $\leq 1$  ppm-years) as illustrated in Figure 1. The highest exposure group ( $> 16$  ppm-years) contained 7 of 33 leukemia cases, but only 3 of their 165 matched control subjects. For the 2 highest exposure categories combined (13 case-sets with  $> 8$  ppm-years cumulative exposure), the OR was 11.3 (95% CI = 2.85-45.1).

In a comparable study in the U.K. petroleum industry,<sup>27</sup> a cut-point of 4.79 ppm-years was used in the analysis. For comparison purposes we analyzed our data using the same cut-point and obtained an OR of 2.51 (95% CI = 1.1-5.7).

The OR associated with cumulative exposure as a continuous measure was 1.65 (95% CI = 1.25-2.17), which is consistent with an increase of 65% for each doubling of mean cumulative exposure.

There was no association between leukemia (with or without adjustment for cumulative benzene exposure) and date of starting work in industry or duration of employment (Table 5). Blue collar workers had a 3-fold risk of leukemia compared with office workers, but this risk disappeared when adjustment was made for cumulative benzene exposure (data not shown). Subjects who had worked longest at an airport had nearly 4 times the risk of leukemia compared with terminal workers but this result was based on small numbers. This finding did not change after adjustment for cumulative

TABLE 2. Lifestyle and Demographic Characteristics of the Cases and Control Subjects

Characteristic	Control Subjects (N = 395)	All Cases (N = 79)	Types of Cancer			
			Leukemia (N = 33)	NHL/MM (N = 46)	MM (N = 15)	NHL (N = 31)
Age in years; mean (range)	54 (26-76)	54 (26-79)	52 (34-71)	54 (26-75)	55 (39-75)	54 (26-70)
Tobacco; no. (%) <sup>*</sup>						
Never smoked	125 (32)	28 (35)	11 (33)	17 (37)	8 (53)	9 (29)
Previous smoker	166 (42)	21 (27)	8 (24)	13 (28)	6 (40)	7 (23)
Current smoker	103 (26)	30 (38)	14 (42)	16 (35)	1 (7)	15 (48)
Alcohol; no. (%)						
Never drank	79 (20)	16 (20)	7 (21)	9 (20)	1 (7)	8 (26)
Previous drinker	10 (3)	2 (3)	1 (3)	1 (2)	0	1 (3)
Current drinker	305 (77)	61 (77)	25 (76)	36 (78)	14 (93)	22 (71)
Country of birth; no. (%)						
Australia	259 (66)	56 (71)	25 (76)	31 (67)	10 (67)	21 (68)
UK	75 (19)	14 (18)	4 (12)	10 (22)	3 (20)	7 (23)
Other	60 (15)	9 (11)	4 (12)	5 (11)	2 (13)	3 (10)

<sup>\*</sup>One control did not record smoking data.

NHL/MM, combined non-Hodgkin lymphoma and multiple myeloma; MM, multiple myeloma; NHL, non-Hodgkin lymphoma.

TABLE 3. Cases and Control Subjects Grouped by Exposure to Benzene Expressed as Cumulative Exposure (ppm-years)

Characteristic	Control Subjects (N = 395)	All Cases (N = 79)	Types of Cancer			
			Leukemia (N = 33)	NHL/MM (N = 46)	MM (N = 15)	NHL (N = 31)
Mean and range of cumulative exposure (ppm-years)	4.7 (0.01–57.3)	7.27 (0.01–52.7)	10.63 (0.09–52.7)	4.85 (0.01–23.4)	4.73 (0.17–23.4)	4.91 (0.01–21.8)
Cumulative exposure (ppm-years); no. (%)						
≤1	138 (35)	18 (23)	3 (9)	15 (33)	4 (27)	11 (35)
>1–2	56 (14)	12 (15)	6 (18)	6 (13)	2 (13)	4 (13)
>2–4	67 (17)	16 (20)	8 (24)	8 (17)	5 (33)	3 (10)
>4–8	64 (16)	12 (18)	3 (9)	9 (20)	2 (13)	7 (23)
>8–16	53 (13)	11 (14)	6 (18)	5 (11)	1 (7)	4 (13)
>16	17 (4)	10 (13)	7 (21)	3 (7)	1 (7)	2 (6)

NHL/MM, combined non-Hodgkin lymphoma and multiple myeloma; MM, multiple myeloma; NHL, non-Hodgkin lymphoma.

benzene exposure. Similar results were found for those whose highest benzene-exposed job was at an airport.

There was a strong association between leukemia risk and exposure to benzene concentrate that was somewhat reduced when cumulative exposure was controlled for. That is, exposure to benzene concentrate resulted in a higher risk of leukemia than exposure to the same amount of benzene encountered in a more dilute form such as in gasoline.

The proportion of subjects whose highest exposed job was in high-intensity exposure categories was greater for cases than control subjects (Table 5). Exposure intensity in the highest exposed job was strongly related to leukemia risk, with the increase starting at around 0.8–1.6 ppm and with those in the highest exposure category being nearly 20 times more likely to develop leukemia than those who were unexposed. Adjusting for

cumulative exposure removed the association between high-intensity exposure and leukemia. However, exposure intensity and cumulative exposure are highly correlated, and goodness-of-fit statistics and the stepwise conditional logistic regression algorithm did not provide unequivocal evidence that would distinguish between the relative contributions of cumulative exposure and exposure intensity to leukemia risk.

The ORs were also calculated by using conditional logistic regression for the leukemia subtypes acute nonlymphocytic leukemia, chronic lymphocytic leukemia, and chronic myeloid leukemia (Table 6); such calculations were not possible for acute

TABLE 4. Association of Leukemia and Non-Hodgkin Lymphoma/Multiple Myeloma by Benzene Exposure Group, From Conditional Logistic Regression Analysis

Cumulative Lifetime Benzene Exposure (ppm-years)	Leukemia OR (95% CI)	NHL/MM OR (95% CI)
≤1*	1.0	1.0
>1–2	3.9 (0.9–17.1)	1.1 (0.4–2.9)
>2–4	6.1 (1.4–26.0)	1.2 (0.5–3.0)
>4–8	2.4 (0.4–13.6)	1.3 (0.5–3.2)
>8–16	5.9 (1.3–27.0)	0.8 (0.3–2.6)
>16	98.2 (8.8–1090)	1.1 (0.3–4.5)

\* Reference category.

NHL/MM, combined non-Hodgkin lymphoma and multiple myeloma; OR, odds ratio; CI, confidence interval.

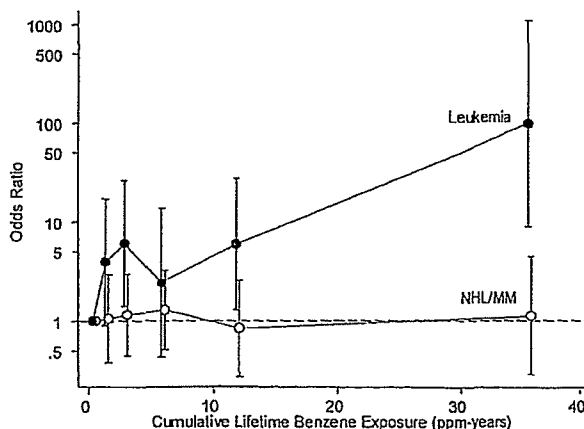

FIGURE 1. Leukemia and Non-Hodgkin Lymphoma/Multiple Myeloma (NHL/MM) odds ratios by geometric benzene exposure groups (ppm-years) displayed at the midpoint of the exposure group. (Circles indicate odds ratios; vertical lines depict confidence intervals).



TABLE 5. Distribution of Exposure Variables for Leukemia Cases and Control Subjects and Results of Matched Analyses of the Risk of Leukemia Using These Variables

Exposure Characteristic	Cases (N = 33) No. (%)	Control Subjects (N = 165) No. (%)	Odds Ratio (95% CI)	Adjusted Odds Ratio* (95% CI)
Start date in industry				
Before 1965 <sup>†</sup>	15 (45)	63 (38)	1.0	1.0
1965–1975	12 (36)	60 (36)	0.6 (0.2–1.9)	0.9 (0.3–3.2)
1975 or later	6 (18)	42 (25)	0.4 (0.1–1.6)	1.0 (0.2–4.8)
Duration of employment truncated at date of diagnosis (y)				
≤11 <sup>†</sup>	15 (19)	77 (19)	1.0	1.0
>11–17	18 (23)	83 (21)	1.2 (0.4–4.0)	0.7 (0.2–2.5)
>17–22.5	12 (15)	81 (21)	1.6 (0.4–5.5)	1.2 (0.3–5.4)
>22.5–29	16 (20)	80 (20)	1.0 (0.2–4.2)	0.4 (0.1–1.9)
>29–43	18 (23)	74 (19)	1.6 (0.4–6.8)	0.4 (0.1–2.7)
Exposure to benzene concentrate				
No <sup>†</sup>	28 (84)	163 (99)	1.0	1.0
Yes	5 (16)	2 (1)	12.5 (2.4–64)	6.3 (1.1–36)
Exposure intensity group based on highest benzene-exposed job (ppm)				
≤0.1 <sup>†</sup>	5 (15)	65 (39)	1.0	1.0
>0.1–0.2	9 (27)	26 (16)	3.9 (1.2–12.6)	1.2 (0.3–4.9)
>0.2–0.4	4 (12)	25 (15)	2.2 (0.5–9.4)	0.5 (0.1–3.2)
>0.4–0.8	4 (12)	11 (7)	6.6 (1.7–25.7)	0.6 (0.1–6.2)
>0.8–1.6	3 (9)	31 (19)	1.6 (0.4–6.7)	0.2 (0.0–2.0)
>1.6–3.2	6 (18)	6 (4)	5.6 (1.0–31.2)	0.4 (0.0–6.1)
>3.2	2 (6)	1 (1)	20.4 (1.6–270)	1.6 (0.1–38)

\*Adjusted for cumulative benzene exposure.

<sup>†</sup>Reference category.

CI, confidence interval.

lymphocytic leukemia because there were only 2 cases. Because there were relatively few cases of the leukemia subtypes, it was necessary to combine the 3 lowest exposure groups and the 2 highest exposure groups. The ORs in the combined higher exposure group were raised relative to the combined lower exposure group for both chronic lymphocytic leukemia and acute nonlymphocytic leukemia.

## DISCUSSION

These data provide strong evidence for an association between previous benzene exposure in the Australian petro-

leum industry and an increased risk of leukemia. However, we did not find an association of benzene with multiple myeloma or non-Hodgkin lymphoma, which is consistent with previous findings.<sup>9,16,17</sup>

In our data, leukemia seems to be associated with lower cumulative exposures than has been observed in other studies. The estimated cumulative exposures were generally similar to those reported for other petroleum industry studies, except that the most highly exposed subjects in our study had cumulative exposures of less than 60 ppm-years, whereas those in other studies were as high as 220 ppm-years.<sup>27,28</sup>

TABLE 6. Association of Leukemia Subtype With Cumulative Benzene Exposure From Conditional Logistic Regression Analysis

Cumulative Lifetime Benzene Exposure (ppm-years)	Leukemia Subtype		
	ANLL (N = 11)	CLL (N = 11)	CML (N = 6)
≤4*	1.00	1.00	1.00
>4–8	0.52 (0.05–5.0)	2.76 (0.42–18.1)	-
>8	7.17 (1.27–40.4)	4.52 (0.89–22.9)	0.91 (0.08–9.8)

\*Reference category.

ANLL, acute nonlymphocytic; CLL, chronic lymphocytic leukemia; CML, chronic myeloid leukemia.

It has been suggested that there might be no increased risk at cumulative exposures below 200 ppm-years<sup>9</sup> or intensity of less than 20-60 ppm.<sup>10</sup> In a recent large cohort study of Chinese workers, the relative risk for all hematologic neoplasms was 2.2 (95% CI = 1.1-4.2) for workers exposed to benzene at estimated average levels of less than 10 ppm.<sup>11</sup> Over a working lifetime this could amount to a cumulative exposure of up to several hundred ppm-years. In our study, the risk of leukemia was increased at all cumulative exposures above 1 ppm-year, with a strong exposure-response relationship. There was no evidence of a threshold.

Leukemia risk in the highest exposure category was 98 (95% CI = 8.8-1090). Combining the 2 highest cumulative exposure groups resulted in an OR of 11.3 (95% CI = 2.85-45.1). This is considerably higher than that observed in a similar petroleum industry study,<sup>28</sup> which found an OR of 2.11 (95% CI = 0.01-138) for leukemia for those in the highest quartile of exposure (8-220 ppm-years). In a similar study,<sup>27</sup> the leukemia OR was 2.13 (95% CI = 0.90-5.03) for those in the highest quintile of exposure (>4.79 ppm-years). In our study, the matched OR for those exposed to greater than 4.79 ppm-years was similar at 2.51 (95% CI = 1.1-5.7).

We found a positive association of benzene exposure with both acute nonlymphocytic leukemia and chronic lymphocytic leukemia. An association between acute nonlymphocytic leukemia and benzene exposure has only been reported previously associated with exposures above 200 ppm-years.<sup>9,16</sup> In a U.K. petroleum industry study,<sup>27</sup> the risk of acute myeloid and monocytic leukemia did not increase with cumulative exposure when analyzed as a continuous variable. However, when categorized into discrete ranges, an odds ratio of 2.8 (95% CI = 0.8-9.4) was found for a cumulative exposure of 4.5-45 ppm-years.<sup>27</sup>

There are a number of possible confounders, including tobacco and alcohol consumption and exposure to other chemicals and radiation. Tobacco and alcohol were not confounding factors in our data. Workers in the petroleum industry are exposed to a wide range of aliphatic and aromatic hydrocarbons found in or derived from crude oil, ranging from natural gas (methane) to bitumen. Known carcinogenic exposures include sunlight, polycyclic aromatic hydrocarbons, asbestos, and possibly other insulating materials. A few, mainly older, workers have had exposure to paint, and some workers in the lubricating oils operations had exposure to white spirit (Stoddard Solvents), methyl ethyl ketone, and toluene. The subjects include some laboratory workers who have had exposure to a number of laboratory reagents.

In 1996, a comprehensive review of risk factors for leukemia concluded that the only confirmed occupational risk factors were exposure to benzene, radiation, and some retroviruses. There is some inconsistent evidence for leukemogenic potential from some pesticides, styrene and butadiene manufacturing, and ethylene oxide.<sup>29</sup> We consider it unlikely

that subjects in this study were occupationally exposed to retroviruses or these other agents. Some workers employed in the petroleum extraction, refining, and distribution industries might have used x-ray machines in laboratories or pipe surveys, but the sources are thought to have been well shielded.

The present study has a number of strengths and weaknesses. The diagnoses of the cases were well established. However, the study was based on a relatively small number<sup>79</sup> of lympho-hematopoietic cancer cases, including 33 leukemias of which there were only 11 acute nonlymphocytic leukemias and only 11 chronic lymphocytic leukemias. This limits the power of the study to detect excess risks for leukemia subgroups, particularly when we stratified the subjects by exposure.

The cases were individually age-matched to control subjects, and both were drawn from the same prospective cohort of workers in the Australian petroleum industry. The cohort has been followed for 20 years with serial identification of jobs, smoking habits, and health status. Only 10 of the 474 subjects (2%) had incomplete job histories. Relatively few subjects in the cohort (6%) have been lost to follow up,<sup>21</sup> and vital status was confirmed every 5 years; thus we are confident that the control subjects were selected from an appropriate risk set.

We estimated the subjects' exposure to benzene quantitatively, on an individual basis, with an algorithm based on a substantial body of exposure data from the Australian petroleum industry.<sup>25</sup> The exposure assessment method was validated,<sup>26</sup> but there are always uncertainties and unknown sources of variation in retrospective exposure assessments. Between-worker variation in exposure measurements, resulting from personal factors such as individual work practice, was not included in the exposure assessment reported here. There was also uncertainty about exposures before 1975 because jobs have changed over the years, but the available exposure data used in the algorithm postdated this period. However, the Health Watch cohort is relatively recent compared with other similar studies in which jobs held before 1920 were assessed.<sup>27,28</sup> Most of the subjects in our case-control study started work after 1965; the earliest start date was 1941. This means that jobs have changed less in our study, and for most jobs we were able to identify changes by interviewing contemporary coworkers. These individuals did not have to recall far distant exposure conditions so their uncertainty was reduced.

For 33 cases, including 13 leukemia cases, the complete job history was obtained after lympho-hematopoietic cancer diagnosis. These cases provided information after diagnosis, about jobs held before 1975, thus introducing some potential for recall bias. These subjects' job histories were constructed from the information gathered during the Health Watch surveys and from company records. This was then sent to the

subject for cross-checking. However, the high degree of agreement with the company records suggests that the self-reported job histories were reasonably accurate and that possible recall bias was low. For the remaining 46 cases, either the complete job history was obtained before diagnosis or only the company job history was used because, for example, the case died before the complete job history collection.

All smoking and drinking data were collected before individual diagnoses, thereby avoiding a potential cause of recall bias.

The benzene exposure assessments were carried out without any knowledge of the names and health status of the subjects to reduce observer bias. Detailed information on the circumstances of the exposure was provided, usually by contemporary work colleagues of the cases and control subjects. Some of the site interviewees might have been able to identify the subjects but were instructed not to reveal their names or health status to the interviewer. This could have given rise to some recall bias, because more effort might have been applied to recalling the tasks with benzene exposure for some of the cases because the connection between benzene exposure and lympho-hematopoietic cancer is widely known within the industry. However, it is unlikely that the employees would distinguish between the risk from benzene exposure of different cancers (leukemia compared with multiple myeloma or non-Hodgkin lymphoma). Our finding of increased risk specifically for leukemia but not for multiple myeloma or non-Hodgkin lymphoma suggests that recall and observer biases do not affect our main results.

It is unlikely that the baseline comparison group was incorrectly defined because this was a nested case-control study with the control subjects selected from the cohort matched by age. However, misclassification of only a few cases from the baseline group into higher exposure groups could markedly distort the exposure-response relation. Although the lowest exposed group contained many office workers, there is no strong socioeconomic gradient for risk of leukemia and the analysis of smoking suggested that this was not a confounding exposure. If there was a strong bias in the exposure estimates leading to differential misclassification, this should have affected the results for multiple myeloma and non-Hodgkin lymphoma as well; the questionnaire respondents would have been unlikely to draw a distinction between one form of hematopoietic cancer or another. The fact that no association was found between multiple myeloma/non-Hodgkin lymphoma and benzene exposure suggests that such bias, if present, was small. We cannot rule out the possibility that some bias was introduced in gathering the occupational histories, although such an effect would presumably be small. If such bias occurred, it could not explain the association between leukemia and benzene exposure that

was found, but might have exaggerated the exposure-risk relationship and hidden a low-exposure threshold.

In summary, these data demonstrate a strong association between benzene exposure and the risk of acute and chronic leukemia. No association was found between benzene and non-Hodgkin lymphoma or multiple myeloma, or between any of the cancers and tobacco or alcohol consumption. The excess risk of leukemia was associated with lower cumulative exposures and lower exposure intensity than have been observed in other studies. We found no evidence of a threshold cumulative exposure below which there is no risk.

### ACKNOWLEDGMENTS

We acknowledge the work carried out by the Health Watch team at Melbourne University and lately at Adelaide University and the petroleum industry occupational hygienists. We also thank Julianna O'Keefe of Monash University for recordkeeping and Alison Street of the Alfred Hospital who reviewed the diagnoses for several of the cases in the study. Finally, we thank the many retirees and current employees from all participating companies who freely answered the lengthy questionnaires.

### REFERENCES

- Wallace LA. Environmental exposure to benzene: an update. *Environ Health Perspect.* 1996;104:1129-1136.
- International Agency for Research on Cancer. *IARC Monograph on the Evaluation of the Carcinogenic Risk of Chemicals: Some Industrial Chemicals and Dyestuffs*, vol 29. Lyon, France: IARC; 1982:93-148.
- Austin H, Delzell E, Cole P. Benzene and leukemia: a review of the literature and a risk assessment. *Am J Epidemiol.* 1983;127:419-439.
- Savitz DA, Andrews KW. Review of epidemiologic evidence on benzene and lymphatic and hematopoietic cancers. *Am J Indust Med.* 1997;31:287-295.
- Infante PF, Rinsky RA, Wagoner JK, et al. Leukemia in benzene workers. *Lancet.* 1977;2:76-78.
- Rinsky RA, Young RJ, Smith AB. Leukemia in benzene workers. *Am J Indust Med.* 1981;2:217-245.
- Brett SM, Rodricks JV, Chinchilli VM. Review and update of leukemia risk potentially associated with occupational exposure to benzene. *Environ Health Perspect.* 1989;82:267-281.
- Lamm SH, Walters AS, Wilson R, et al. Consistencies and inconsistencies underlying the quantitative assessment of leukemia risk from benzene exposure. *Environ Health Perspect.* 1989;82:289-297.
- Wong O. Risk of acute myeloid leukaemia and multiple myeloma in workers exposed to benzene. *Occup Environ Med.* 1995;52:380-384.
- Schnatter RA, Nicolich MJ, Bird MG. Determination of leukemogenic benzene exposure concentrations: refined analyses of the Pliofilm cohort. *Risk Anal.* 1996;16:833-840.
- Hayes RB, Yin S-N, Dosemeci M, et al. Benzene and the dose-related incidence of hematologic neoplasms in China. *J Natl Cancer Inst.* 1997;89:1065-1071.
- Wong O, Raabe GK. Cell-type specific leukemia analyses in a combined cohort of more than 208,000 petroleum workers in the United States and the United Kingdom 1937-1989. *Regul Toxicol Pharmacol.* 1995;21:307-321.
- Infante PF. Benzene and leukaemia: cell types, latency and amount of exposure. In: Imbriani M, Ghittori S, Pezzagno G, et al., eds. *Advances in Occupational Medicine and Rehabilitation*. Fondazione Salvatore Maugeri Edizioni: Pavia 265;1995:107-120.

14. Infante PF. State of the science of carcinogenicity of gasoline with particular reference to cohort mortality study results. *Environ Health Perspect*. 1993;101:105–109.
15. Goldstein BD. Is exposure to benzene a cause of human multiple myeloma? *Ann N Y Acad Sci*. 1990;609:225–234.
16. Bergsagel DE, Wong O, Bergsagel PL, et al. Benzene and multiple myeloma: appraisal of the scientific evidence. *Blood*. 1999;94:1174–1182.
17. Wong O, Raabe GK. Non-Hodgkin's lymphoma and exposure to benzene in a multinational cohort of more than 308,000 petroleum workers, 1937 to 1996. *J Occup Environ Med*. 2000;42:554–568.
18. Health and Safety Executive. *Occupational Exposure Limits EH40/2000*. HSE Books; 2000.
19. European Community. *European Directive 90/394/EEC, Annex III on the Protection of Workers From the Risks Related to Exposure to Carcinogens at Work, as Amended by Council Directive 97/42/EC*. 1997.
20. ACGIH. *Threshold Limit Values for Chemical Substances and Physical Agents and Biological, Exposure Indices*. Cincinnati: ACGIH; 2001.
21. Bisby JA, Adams GG. *Health Watch Tenth Report*. The University of Melbourne; 1999.
22. Bennett J, Catovsky D, Daniel M. Proposals for the classification of the acute leukaemias. French-American-British (FAB) co-operative group. *Br J Haematol*. 1976;33:451–458.
23. Armstrong TW, Pearlman ED, Schnatter RA, et al. Retrospective benzene and total hydrocarbon exposure assessment for a petroleum marketing and distribution worker epidemiology study. *Am Ind Hyg Assoc J*. 1996;57:333–343.
24. Lewis SJ, Bell GM, Cordingley N, et al. Retrospective estimation of exposure to benzene in a leukaemia case-control study of petroleum marketing and distribution workers in the United Kingdom. *Occup Environ Med*. 1997;54:167–175.
25. Glass DC, Adams GG, Manuell RW, et al. Retrospective exposure assessment for benzene in the Australian Petroleum Industry. *Ann Occup Hyg*. 2000;44:301–320.
26. Glass DC, Gray CN, Adams GG, et al. Validation of exposure estimation for benzene in the Australian petroleum industry. *Toxicol Indust Health*. 2001;17:113–127.
27. Rushton L, Romaniuk H. A case-control study to investigate the risk of leukaemia associated with exposure to benzene in petroleum marketing and distribution workers in the United Kingdom. *Occup Environ Med*. 1997;54:152–166.
28. Schnatter RA, Armstrong TW, Nicolich MJ, et al. Lymphohaemopoietic malignancies and quantitative estimates of exposure to benzene in Canadian petroleum distribution workers. *Occup Environ Med*. 1996;53:773–781.
29. Linet MS, Cartwright RA. The leukemias. In: Schottenfeld D, Fraumeni JF, eds. *Cancer Epidemiology and Prevention*. Oxford: Oxford University Press; 1996.

# CHARACTERISTICS OF DISSOLVED PETROLEUM HYDROCARBON PLUMES

## RESULTS FROM FOUR STUDIES

C.J. Newell and J.A. Connor, Groundwater Services, Inc.

API Soil / Groundwater Technical Task Force

### EXECUTIVE SUMMARY

Recent studies of over 600 groundwater contamination sites throughout the U.S. provide important information regarding the fate and transport of petroleum hydrocarbons in the subsurface. This API research summary examines the findings of four independent research studies and addresses several key technical issues regarding the assessment and remediation of BTEX (benzene, toluene, ethylbenzene, xylene) plumes. On-going research regarding MTBE plume characteristics will be addressed in a future bulletin as data become available.

**Key Finding:** Most BTEX groundwater plumes are less than 200 ft in length and are in a STABLE or SHRINKING condition.

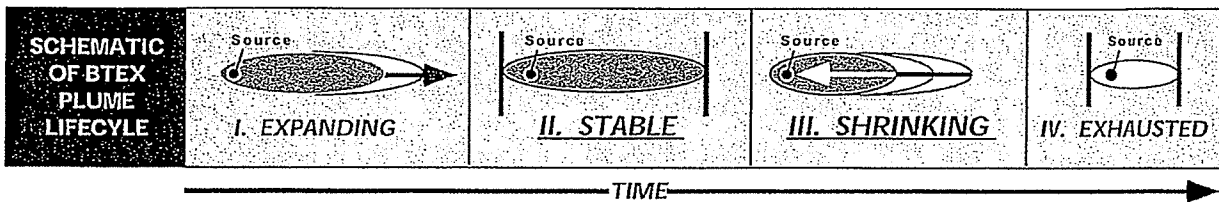

### THE FOUR STUDIES

This bulletin summarizes information from four separate multi-site plume studies. Each study involved detailed analysis of data from a large number of sites (primarily underground storage tank facilities) to identify the key characteristics of groundwater contaminant plumes caused by petroleum hydrocarbon releases. Two comprehensive studies (California and Texas) evaluated how dissolved petroleum hydrocarbon plumes change over time.

In all four studies, detailed technical information regarding groundwater flow parameters and plume characteristics for each site were compiled from technical reports or questionnaires completed by site hydrogeologists or engineers. In combination, the four studies define the typical features of a dissolved hydrocarbon plume based on a cumulative database of 604 sites.

This API bulletin reviews the general methodology and principal conclusions of each study and uses these findings to answer several important questions related to the assessment and remediation of groundwater impacts associated with petroleum releases.

#### Technical Issues Regarding Dissolved BTEX in Groundwater:

- Typical plume length
- Persistence over time
- Effect of remediation
- Key factors in plume length
- Plume stability condition
- BTEX vs. other contaminants
- Drinking water impacts

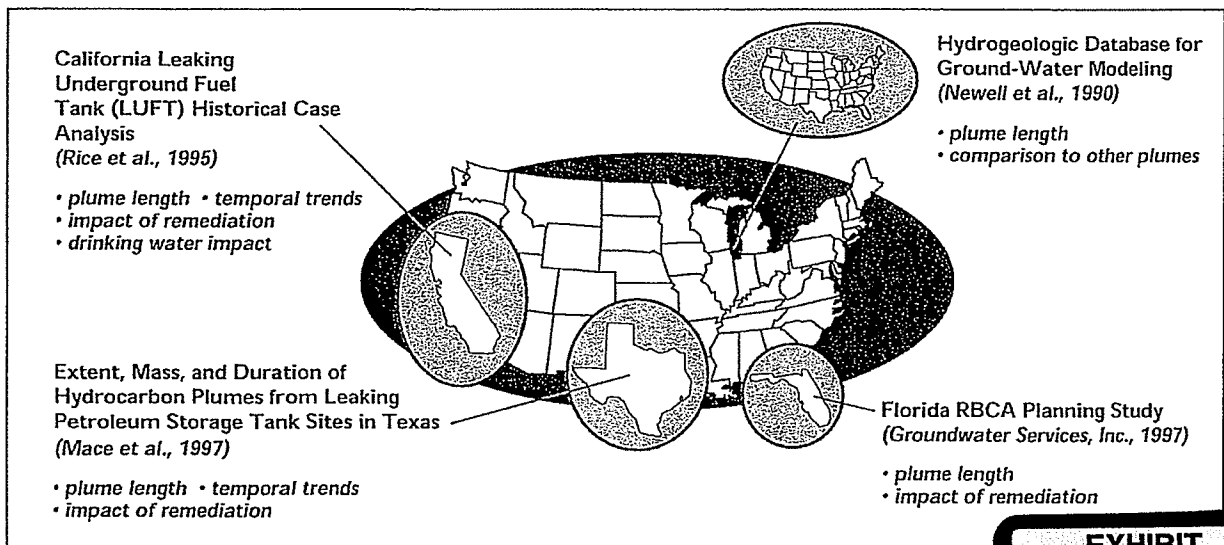

## THE FOUR STUDIES (Cont'd)

---

### **California Leaking Underground Fuel Tank (LUFT) Historical Case Analysis**

Rice, D.W., R.D. Grose, J.C. Michaelsen, B.P. Doohar, D.H. MacQueen, S.J. Cullen, W.E. Kastenber, L.G. Everett, M.A. Marino. CA Environmental Protection Dept., Nov. 16, 1995.



☒ **APPROACH:** This study, also referred to as the Lawrence Livermore National Laboratory (LLNL) Study, involved compilation and analysis of a detailed electronic database for 271 LUFT sites. Groundwater flow gradients and the average length and concentration of benzene plume were characterized on the basis of static water level data and groundwater time-series sampling records.

☒ **KEY RESULTS:** Plume lengths "change slowly and stabilize at relatively short distances from the FHC (fuel hydrocarbon) release site" (90% of sites less than 255 ft). The median plume length was 101 ft for one of the two methods of calculation (see the following page). Plume lengths tend to change slowly with time, while average plume concentrations decline more rapidly. Hydrogeologic parameters (e.g., hydraulic conductivity, gradient) appear to have little relationship to plume length. Finally, "while active remediation may help reduce plume benzene concentrations, significant reductions in benzene concentrations can occur over time, even without active remediation."

---

### **Extent, Mass, and Duration of Hydrocarbon Plumes from Leaking Petroleum Storage Tank Sites in Texas**

Mace, R.E., R.S. Fisher, D.M. Welch, and S.P. Parra. Bureau of Economic Geology, University of Texas at Austin, Austin, Texas. Geologic Circular 97-1, 1997.



☒ **APPROACH:** The Texas Bureau of Economic Geology (BEG) evaluated groundwater impacts from fuel hydrocarbon releases at 217 sites in Texas. Groundwater plume lengths and concentration trends were analyzed in a manner similar to the California study (see Rice et al., above). In addition, hydraulic gradient and groundwater flow directions were characterized for various hydrogeologic and climatic regions of Texas.

☒ **KEY RESULTS:** Most benzene plumes (75%) are less than 250 ft long and have either stabilized or are decreasing in length and concentration. The median plume length was 181 ft. Only 14% are increasing in concentration, and only 3% are increasing in length. The length of a benzene plume cannot be predicted on the basis of either site hydrogeology or previous remediation activities. Benzene plume characteristics are not statistically different between sites where groundwater remediation activities have or have not been implemented, although the authors state that these activities should "logically shorten the time required to decrease plume length and concentration."

---

### **Florida RBCA Planning Study**

Groundwater Services, Inc. Prepared for Florida Partners in RBCA Implementation, Groundwater Services, Inc., Houston, Texas. 1997. www.GSI-net.com



☒ **APPROACH:** The Florida RBCA (Risk-Based Corrective Action) Planning Study involved collection and analysis of groundwater data from 117 leaking underground storage tank (LUST) sites distributed throughout 33 counties in Florida. Using these data, the report addresses the cost significance of various policy decisions related to development of the Florida RBCA regulations. For use in this bulletin, the plume maps and detailed site questionnaires compiled for 74 sites were reanalyzed to define typical plume properties.

☒ **KEY RESULTS:** The median plume length among these Florida LUST sites is 90 ft based on available benzene and BTEX data. The shorter plume lengths observed in this database may be related to the varying detection limits used for plume delineation. For plumes delineated to a 50 ppb benzene limit (51 sites), median plume length was 90 ft, compared to 120 ft for plumes delineated to 1 ppb benzene (21 sites). In addition, 51% of the Florida database sites are currently or had previously been subject to groundwater remediation efforts.

---

### **A Hydrogeologic Database for Ground-Water Modeling**

Newell, C.J., L.P. Hopkins, and P.B. Bedient. Ground Water, Vol. 28, No. 5, Sept./Oct. 1990. pp. 703-714. API, 1989. Hydrogeologic Data Base for Groundwater Modeling, API Publication No. 4476, Washington, D.C.



☒ **APPROACH:** Hydrogeologic and chemical information from 400 site investigations across the U.S. was obtained in a national survey of National Ground Water Association members conducted in 1990. This 400-site database (available in spreadsheet form from the API Information Specialist, ehs@api.org) includes groundwater plume dimensions for a broad range of groundwater contaminants, including 42 service station BTEX sites, 40 non-service station BTEX sites, 78 chlorinated ethene sites, 25 non-ethene solvent sites, and 21 inorganic sites. For use in this bulletin, these data were reanalyzed to define typical plume properties for each chemical class.

☒ **KEY RESULTS:** The 42 service station sites show a median benzene/BTEX plume length of 213 ft. This database includes a higher percentage of longer plumes, with six BTEX plume lengths greater than 900 ft. On average, however, BTEX plumes are significantly smaller than the other chemical classes reported in this study, as discussed later in this Bulletin.

# WHAT IS THE LIMIT OF MIGRATION OF DISSOLVED PETROLEUM HYDROCARBON PLUMES?

## COMBINED RESULTS FROM FOUR STUDIES:

PERCENTAGE OF PLUMES OF DIFFERENT LENGTHS (604 SITES)

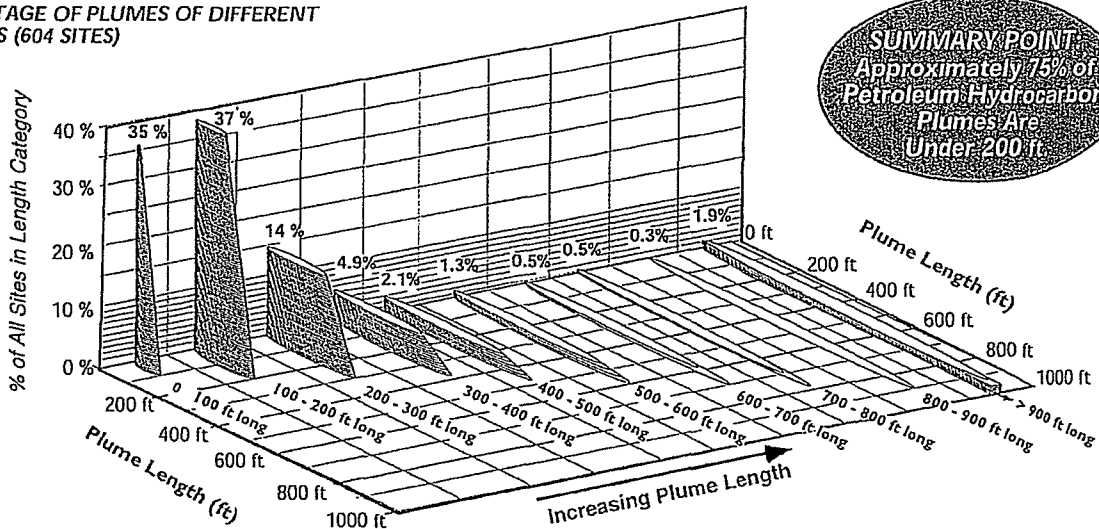

**SUMMARY POINT**  
Approximately 75% of Petroleum Hydrocarbon Plumes Are Under 200 ft

### INDIVIDUAL STUDY RESULTS:

<b>ALL SITES</b>	
<b>SUMMARY - ALL SITES</b>	
Maximum Length:	3020 ft
90th Percentile:	319 ft
75th Percentile:	203 ft
<b>MEDIAN LENGTH:</b>	<b>132 ft</b>
25th Percentile:	80 ft
Minimum Length:	8 ft

CALIFORNIA	TEXAS	FLORIDA	HGDB
271 Sites	217 Sites	74 Sites	42 Sites
Summary	Summary	Summary	Summary
Max 1713 ft	Max 1619 ft	Max 600 ft	Max 3020 ft
90th % 255 ft	90th % 382 ft	90th % 211 ft	90th % 945 ft
75 % 146 ft	75 % 250 ft	75 % 158 ft	75 % 400 ft
<b>MEDIAN LENGTH</b>	<b>MEDIAN LENGTH</b>	<b>MEDIAN LENGTH</b>	<b>MEDIAN LENGTH</b>
101 ft	131 ft	90 ft	243 ft
25th % 66 ft	25th % 137 ft	25th % 60 ft	25th % 85 ft
Min 8 ft	Min 54 ft	Min 12 ft	Min 15 ft

• LOCATION OF SITES:	CALIFORNIA	TEXAS	FLORIDA	ENTIRE U.S.
• Plume constituent(s):	Benzene	Benzene	Benzene, BTEX	Mostly benzene, BTEX constituents
• Plume Delineation Limit:	10 ppb	10 ppb	1 - 50 ppb	Not reported; probably analytical detection limit.
• Types of Sites:	UST sites with affected groundwater. No fractured rock sites.	UST sites with affected groundwater. Includes limestone aquifers.	UST sites with affected groundwater.	UST sites at service stations located in various hydrogeologic settings.
• Method For Determining Plume Length:	<i>Modeled:</i> Length extrapolated from 2-D transport models fit to site monitoring data. Reported results for exponential and error-function equations (summary stats above from error function).	<i>Modeled:</i> Length extrapolated from 2-D GW transport model fit to site monitoring data. Used exponential equation only.	<i>Measured:</i> Length derived from site plume maps. Data analyzed as part of this bulletin.	<i>Reported:</i> Plume lengths reported by site consultants in survey questionnaires. Data analyzed as part of this bulletin.
• Sites w/ Soil Vapor Extract.	— Not reported	— 105 of 479 (22%)	— Not reported	— Not reported
• Sites w/ GW Pump & Treat	— 53 of 208 sites (26%)	— 92 of 479 sites (19%)	— 32 of 74 sites (43%)	— Not reported
• Sites w/ GW Sparging	— Not reported	— 22 of 479 sites (5%)	— 6 of 74 sites (8%)	— Not reported

(note different #s of sites reported)

# HOW MANY PETROLEUM PLUMES ARE SHRINKING? STABLE? EXPANDING?

## APPROACH

Both the California and the Texas studies (Rice et al., 1995; Mace et al., 1997) analyzed changes over time in the length and average concentration of dissolved hydrocarbon plumes. For the California study, these evaluations were conducted on a subset of sites having at least 6 wells and 8 sampling episodes extending over multiple years. Typical monitoring records for the Texas study ranged from 4 to 7 years as shown in data from two typical sites to the right.

Plume stability trends were determined as follows:

**Plume Length Trend:** For each sampling episode, the plume length from the source to the 10 ppb concentration point was extrapolated using a 2-D groundwater transport model calibrated to the site monitoring data. Length vs. time was plotted for each site to define change over time.

**Plume Concentration Trend:** For each sampling episode, the average benzene concentration in the plume area was estimated using Delauney triangulation (Isaaks and Srivastava, 1989), an area-weighted averaging procedure involving subdivision of the plume area into triangular segments defined by adjacent wells. Average concentration vs. time was plotted for each site to define change over time.

These methods do not account for plume spreading beyond the area described by the monitoring well array. However, both studies found this approach to be sufficiently robust to accurately characterize plume trends over time.

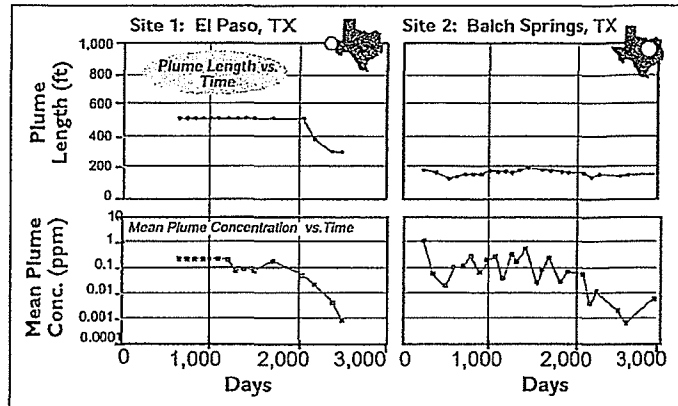

## KEY RESULTS

Based on the observed trends, the studies grouped the plumes into four categories:

- **Expanding:** Residual source present. Mass flux of contaminants exceeds assimilative capacity of aquifer.
- **Stable:** Insignificant changes. Active or passive remediation processes are controlling plume length.
- **Shrinking:** Residual source nearly exhausted, and active or passive remediation processes significantly reducing plume mass.
- **Exhausted:** Average plume concentration very low (e.g., 1 ppb) and unchanging over time. Final stages of source zone dissolution over a relatively small area at a site.

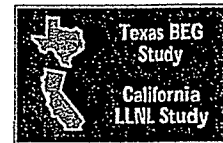

As shown in the conceptual plume lifecycle figures below, of the nearly 500 sites addressed by this analysis, nearly 75% were found to be in either a stable or shrinking condition, based on analyses of both plume length and concentration. Plume concentrations were predominantly shrinking (47 to 59%), whereas lengths were frequently stable (42 to 61%). These results suggest that dissolved hydrocarbon plumes tend to reduce more rapidly in concentration than in length. Similar results were observed in a plume study performed by Buscheck et al. (1996), where 67% of 119 plumes in northern California were found to be stable/shrinking in length, and 91% had stable/diminishing concentrations.

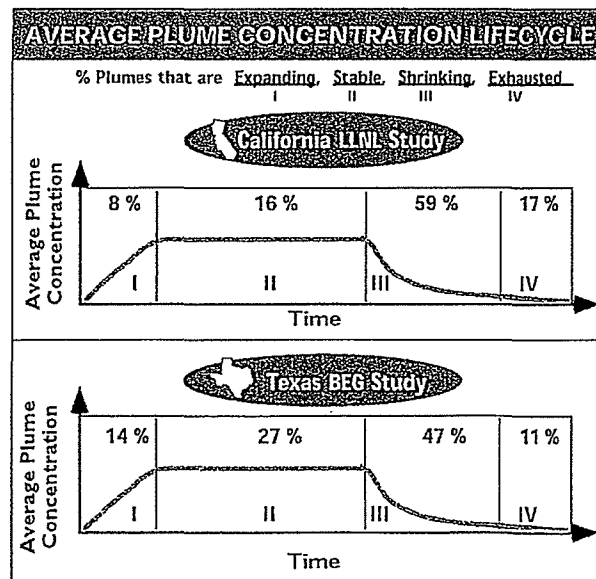
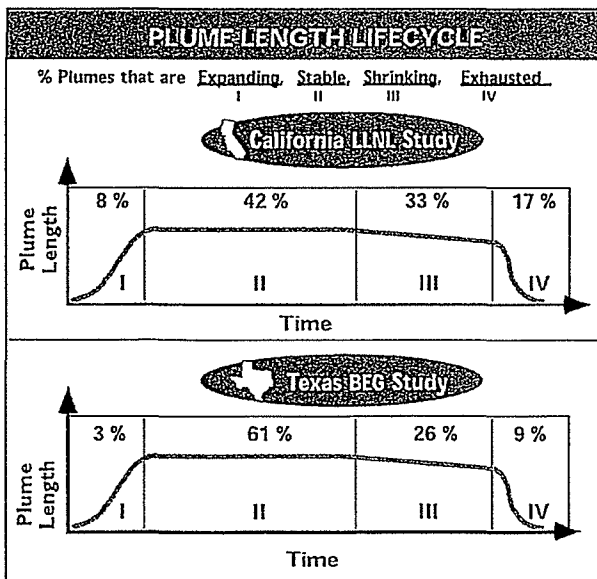





## HOW LONG WILL BTEX PLUMES PERSIST?

### CALIFORNIA & TEXAS STUDIES: 90% Attenuation of Average Concentration of Shrinking Plumes

For those plumes characterized as shrinking (see page 4), both the California and Texas studies (Rice et al., 1995; Mace et al., 1997) included an evaluation of the time required for the average plume concentration to reduce by 90%. The rates of change calculated for each data set are shown in the table to the right.

#### Time Required for 90% Attenuation in Average Concentration for Shrinking Plumes:

 161 SITES	MEDIAN SITE IN CALIFORNIA:	3.2 yrs	 90 SITES	MEDIAN SITE IN TEXAS:	1.4 yrs
	10th Percentile:	1.5 yrs		10th Percentile:	0.7 yrs
	90th Percentile:	7 yrs		90th Percentile:	2.7 yrs

Note that, in these analyses, the average concentration term corresponds to an area-weighted average BTEX concentration derived using the Delauney triangulation method for each groundwater sampling episode. Consequently, trends in this concentration term should be representative of the total plume mass. Data from the California and Texas studies show that, once a dissolved BTEX plume begins to shrink (a condition observed at roughly 50 - 60% of the LUST sites in these studies), the rate of decline in plume mass is relatively rapid. Based on the median rate of mass reduction reported in these studies, for a shrinking plume, only 5 to 10 years are required for the average plume BTEX concentration to drop from an initial level of 1 ppm down to 1 ppb. (This assumes a first order decay model applies over three orders of magnitude of concentration reduction.) At this point, the plume reaches an exhausted condition, which may represent low levels of BTEX persisting in source-area wells for an extended time period thereafter.

## WHAT IS THE EFFECT OF REMEDIATION ON BTEX PLUMES?

Three of the four studies evaluated the performance of remediation efforts in reducing or controlling petroleum hydrocarbon plumes. Based on a review of large site populations, the studies consistently draw a conclusion that runs counter to expectations: soil and groundwater remediation efforts did not result in smaller BTEX plumes.

### QUOTES



(Rice et. al, 1995)

"While active remediation may help reduce plume benzene concentrations, significant reductions in benzene concentrations can occur with time, even without active remediation." (pg. EX-2)

"At low concentration sites, pump and treat increases the probability of having a negative average benzene concentration trend by roughly a factor of two, while it has essentially no impact on probability at high concentration sites." (pg. 13)

"An analysis of plume length categories shows that none of the remediation treatment variables have a significant impact on the relative frequencies of the different categories." (pg. 13)

PROBABILITY (P) OF DECREASING CONCENTRATION TREND		
Pump & Treat Site?	Site Over-Excavated?	P
-	-	52 %
√	-	71 %
-	√	64 %
√	√	80 %

\* 208 Sites > 1 ppb avg. conc.



(Mace et. al, 1997)

"The use of active ground-water remediation has not yet resulted in a lower median plume length at LPST sites throughout the state where corrective action is under way. This does not mean that remediation does not improve ground-water conditions at individual sites, but that when all LPST sites are reviewed, plume lengths at sites with remediation do not appear different from plume lengths at sites without remediation." (pg. 34)

"This probably means that significant spills occur before being detected and that most plumes are in place and in equilibrium before active remediation takes effect." (pg. 34)

"We found no difference in plume length between different remediation techniques and sites with no remedial action." (pg. 33)

	% OF PLUMES THAT ARE:		
	Stable	Shrinking	Exhaus.
67 Sites WITH Pump & Treat	35 %	61 %	4 %
117 WITHOUT Pump & Treat	38 %	52 %	10 %



(GSI, 1997)

"Of the 117 sites included in this study, affected soils have been previously removed at 28 sites. For these 28 sites, the estimated median groundwater source mass is approximately 34% lower than the median groundwater source mass where overlying soils have not yet been removed. These data suggest that, while the soil removal actions have served to reduce groundwater impacts, a significant percentage of the contaminant source (66%) remains in place in the saturated, water-bearing unit." (pg. 21)

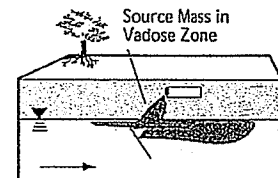

"..soil removal would not significantly affect groundwater remediation requirements." (pg. 21)

# WHAT ARE THE FACTORS THAT CONTROL BTEX PLUME LENGTH?

## TEXAS AND CALIFORNIA STUDIES

The California and Texas studies attempted to correlate plume length with various hydrogeologic factors. In both studies, plumes were segregated into two subsets (shallow vs. deep) and correlation coefficients were calculated for plume length vs. a range of site parameters. Results of these analyses are summarized below.

RESULTS: TEXAS STUDY	RESULTS: CALIFORNIA STUDY
<p style="text-align: right; margin-right: 20px;"><b>217 SITES</b></p> <p>The Texas study (Mace et al., 1997) concluded that plume length could not be predicted by the following variables:</p> <ul style="list-style-type: none"> <li>• Depth to water</li> <li>• Hydraulic gradient</li> <li>• % Organic Carbon in water-bearing zone</li> <li>• Thickness of sweep (smear) zone</li> <li>• Hydrogeologic setting (in unconsolidated media)</li> <li>• Previous remediation activities (see page 5)</li> </ul> <p>The authors concluded that "hydrogeologic site characteristics and site activities considered in this study do not explain the variation in average plume length or plume mass and concentration."</p> <p>The report identifies other factors, such as the amount of spilled fuel and natural biodegradation rate, as having a greater influence than hydrogeology or previous remediation activities.</p>	<p style="text-align: right; margin-right: 20px;"><b>271 SITES</b></p> <p>The California study (Rice et al., 1995) concluded that plume length was not correlated to:</p> <ul style="list-style-type: none"> <li>• Groundwater depth</li> <li>• Saturated thickness</li> <li>• Free product thickness</li> <li>• Hydraulic gradient</li> <li>• Number of site layers</li> <li>• Previous remediation activities (see page 5)</li> </ul> <p>The authors concluded that: "Individual or combinations of other hydrogeologic variables have little apparent relationship to plume characteristics. Correlations among a variety of hydrogeologic variables and plume length show no indications of interaction. Transport indices that in theory should affect plume length, such as groundwater flow velocity, show no correlation."</p> <p>They attributed the lack of correlation to the presence of other controlling but not measured variables (such as source mass and biodegradation rate), scatter in the hydrogeologic data, and cyclical change in hydrogeologic variables that causes a delayed effect on plume length, and general site complexity wherein each site has a unique set of controlling variables.</p>

These studies suggest that the size of the release is probably one of the key variables that controls plume length. Larger sources (in terms of mass, width, and affected soil volume) mean that more dissolved-phase constituents are transferred to groundwater, creating longer dissolved phase plumes.

# HOW MUCH GROUND WATER IS AFFECTED BY BTEX PLUMES?

An upper-range estimate of the total volume of groundwater resources impacted by releases from LUST sites can be obtained using a calculation method described in the California study (Rice et al., 1995). In this method, the 95th percentile BTEX plume volume observed in the California study (i.e., 0.7 acre ft. or 230,000 gallons) is multiplied by the total number of reported LUST sites to obtain a total affected groundwater volume. Dividing this value by the total groundwater basin storage capacity provides an estimate of the percentage of resources impacted by LUST sites. Results for both California and the U.S. are provided below. Note that LUST sites usually affect shallow water table aquifers not typically used for public supply.

	BTEX Plume Volume (95%)	$\times$	No. of LUST Sites	$=$	Total BTEX GW Volume	$\div$	Total GW Resource Volume	$=$	% Total GW Resources Impacted
	0.7 acre-ft		10,000		7000 acre-ft		1.3 billion acre-ft		0.0005 %
	0.7 acre-ft.		358,000 (U.S. EPA, 1998)		250,000 acre-ft		614.3 billion acre-ft (Lehr, 1985)		0.00004 %

## HOW ARE BTEX PLUMES DIFFERENT FROM OTHER PLUMES?

The HGDB Study (Newell et al., 1990) provides plume length data for a variety of contaminants, including BTEX, chlorinated solvents, and brine releases. This chart shows plume widths and lengths as reported by HGDB respondents. As shown, BTEX plumes are much smaller than other types of plumes. Likely causes for this difference include: i) the smaller source zone area associated with BTEX releases from LUST sites, and ii) the more biodegradable nature of BTEX constituents relative to the other contaminants. Note that other studies are in progress to characterize other types of plumes (e.g., Happel et al., 1998; Mace, 1998; Newell et al., 1998).

### REFERENCES

- ☐ American Petroleum Institute, 1989. *Hydrogeologic Data Base for Groundwater Modeling* API Publication No. 4476, API, Washington, DC. The database is available on diskette (Lotus or Microsoft Excel); contact the API Information Specialist at ehs@api.org.
- ☐ Buscheck, T.E., D.C. Wickland, and D.L. Kuehne, 1996. "Multiple Lines of Evidence to Demonstrate Natural Attenuation of Petroleum Hydrocarbons," *NGWA Petroleum Hydrocarbons Conference*, Houston, TX.
- ☐ Groundwater Services, Inc., 1997. *Florida RBCA Planning Study*, prepared for Florida Partners in RBCA Implementation, Groundwater Services, Inc., Houston, Texas, 1997. www.GSI-net.com
- ☐ Happel, A.M., E.H. Beckenbach, and R. U. Halden, 1998. *An Evaluation of MTBE Impacts to California Groundwater Resources*, Lawrence Livermore National Laboratory, University of California, Livermore, California, UCRL-AR-130897, June 11, 1998.
- ☐ Isaaks, E.H., and R.M. Srivastava, 1989. *An Introduction to Applied Geostatistics*, Oxford University Press, New York, NY.
- ☐ Lehr, J.H. 1985. "Re-Evaluating the Extent of Groundwater Contamination," *Water and Pollution Control*, May/June 1985.
- ☐ Mace, R.E. and W.J. Choi. 1998. The Size and Behavior of MTBE Plumes in Texas. In proceedings of Petroleum Hydrocarbons & Organic Chemicals in Ground Water. Nov. 11-13, 1998, Houston, TX, pp. 1-12. National Ground Water Assoc. Westerville, OH.
- ☐ Mace, R.E., R.S. Fisher, D.M. Welch, and S.P. Parra, 1997. *Extent, Mass, and Duration of Hydrocarbon Plumes from Leaking Petroleum Storage Tank Sites in Texas*, Bureau of Economic Geology, Univ. of Texas at Austin. Geologic Circular 97-1, 1997.
- ☐ Newell, C.J., L.P. Hopkins, and P.B. Bedient, 1990. "A Hydrogeologic Database for Groundwater Modeling," *Ground Water*, Vol. 28, No. 5, Sept./Oct. 1990. pp. 703-714.
- ☐ Newell, C.J., A.P. Smith, C.E. Aziz, T.A. Khan, and J.R. Gonzales, 1998. "BIOCHLOR: A Planning-Level Natural Attenuation Model and Database for Solvent Sites," *Natural Attenuation, Chlorinated and Recalcitrant Compounds*, C.B. Wickramanayake and R.E. Hinchee, Eds., First International Conference on Remediation of Chlorinated and Recalcitrant Compounds, Monterey, California, May 18-21, 1998, pp. 237-242.
- ☐ Rice, D.W., R.D. Grose, J.C. Michaelsen, B.P. Dooher, D.H. MacQueen, S.J. Cullen, W.E. Kastenberg, L.G. Everett, M.A. Marino, 1995. *California Leaking Underground Fuel Tank (LUFT) Historical Case Analysis*, Environmental Protection Dept., Nov. 16, 1995.
- ☐ U.S. EPA, 1998. *Semi-Annual Corrective Action Activity Report*, EPA Office of Underground Storage Tanks.

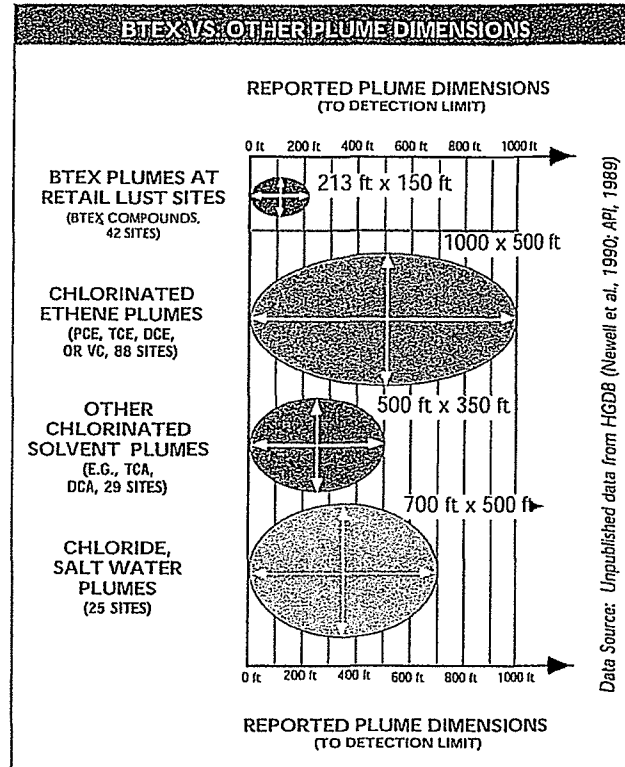

# API Soil & Groundwater Research Publications

**Publ 4668, Delineation and Characterization of the Borden MTBE Plume: An Evaluation of Eight Years of Natural Attenuation Processes, June 1998**

In 1988, a natural gradient tracer test was performed in the shallow sand aquifer at Canada Forces Base (CFB) Borden to investigate the fate of a methyl-tertiary-butyl-ether (MTBE) plume introduced into the aquifer. Solutions of groundwater mixed with oxygenated gasoline were injected below the water table along with chloride (Cl<sup>-</sup>), a conservative tracer. The migration of benzene, toluene, ethylbenzene, the xylenes (BTEX); MTBE; and Cl<sup>-</sup> was monitored in detail for about 16 months. The mass of BTEX in the plume diminished significantly with time due to intrinsic biodegradation. MTBE, however, was not measurably attenuated. In 1995-96, a comprehensive groundwater sampling program was undertaken to define the mass of MTBE still present in the aquifer. Only about 3 percent of the initial MTBE mass was found, and it is hypothesized that biodegradation played an important role in its attenuation. Additional evidence is necessary to confirm this possibility. Pages: 88.

Order Number: I46680, Price: \$30.00

**Publ 4657, Effects of Sampling and Analytical Procedures on the Measurement of Geochemical Indicators of Intrinsic Bioremediation: Laboratory and Field Studies, November 1997**

This study evaluates the effects of various sampling and analytical methods of collecting groundwater geochemical data for intrinsic bioremediation studies. Sampling and analytical methods were tested in the laboratory and in the field. Several groundwater sampling and analytical methods may be appropriate for measuring geochemical indicators of intrinsic bioremediation. The methods vary in accuracy, level of effort, and cost. Pages: 86.

Order Number: I46570, Price: \$30.00

**Publ 4658, Methods for Measuring Indicators of Intrinsic Bioremediation: Guidance Manual, November 1997**

This guidance manual is intended to be a resource for practitioners of intrinsic bioremediation in allowing selection of sampling and analytical methods that meet project-specific and site-specific needs in scoping field investigations, provides procedures that will improve the representative quality of the collected data, and considers potential biases introduced into data through the sampling and analytical techniques employed in the site investigation. Pages: 96.

Order Number: I46580, Price: \$35.00

**Publ 4654, Field Studies of BTEX and MTBE Intrinsic Bioremediation, October 1997**

A gasoline release field site in the Coastal Plain of North Carolina was monitored for more than three years to allow calculation of in situ biodegradation rates. Laboratory microcosm experiments were performed to further characterize the biodegradation of BTEX and MTBE under ambient, in situ conditions. Finally, groundwater modeling studies were conducted to facilitate the interpretation of field data and to evaluate various approaches for predicting the fate and effects of these gasoline constituents in the subsurface. Pages: 244.

Order Number: I46540, Price: \$40.00

**Publ 4627, In Situ and On-Site Biodegradation of Refined and Fuel Oils: A Review of Technical Literature 1988-1991, June 1995**

This report reviews more than 200 technical articles published between 1988 and 1991 in the area of on-site and in situ bioremediation of petroleum hydrocarbons. It focuses specifically on current field and laboratory research related to petroleum hydrocarbon biodegradation including biodegradation of crude oil and solvents. Recent work in fate and transport modeling that can be applied to petroleum hydrocarbon contamination in groundwater is also covered. The review is designed to complement an earlier (pre-1988) review published by the U.S. Navy. Pages: 146.

Order Number: I46270, Price: \$30.00

**DR 200, Modeling Aerobic Biodegradation of Dissolved Hydrocarbons in Groundwater, April 1995**

This report describes a 3-D groundwater transport model that accurately characterizes the nature of aerobic biodegradation, i.e., the mixing of oxygen and dissolved hydrocarbons at plume edges of petroleum spills to the subsurface. The report also demonstrates the differences between spreading and mixing phenomena. The approaches in this report will be used to develop user-friendly biodegradation models which will be helpful in site-specific evaluations. The use of such models could lead to shorter and less expensive cleanups at some sites. Pages: 76.

Order Number: I00200, Price: \$30.00

**Publ 4593, Transport and Fate of Non-BTEX Petroleum Chemicals in Soils and Groundwater, September 1994**

Order Number: I45930, Price: \$40.00

**Publ 4601, Transport and Fate of Dissolved Methanol, MTBE and Monoaromatic Hydrocarbons in a Shallow Sand Aquifer, April 1994**

Order Number: I46010, Price: \$65.00

**Publ 4551, Treatment of Gasoline-Contaminated Groundwater Through Surface Application: Laboratory Experiments, July 1994**

Order Number: I45510, Price: \$55.00

**Publ 4552, Treatment of Gasoline-Contaminated Groundwater through Surface Application: A Prototype Field Study, July 1994**

Order Number: I45520, Price: \$40.00

**Publ 4415, Literature Survey: Unassisted Natural Mechanisms to Reduce Concentrations of Soluble Gasoline Components, August 1985**

Order Number: I44150, Price: \$25.00

**Publ 4476, Hydrogeologic Data Base for Groundwater Modeling, February 1989**

Order Number: I44760, Price: \$25.00

NOTE: Prices are subject to change.

**Copies of these publications are available from API's Publications Department, (202) 682-8375. For more information about the research, contact the Health, Environment, & Safety Information Specialist at the American Petroleum Institute by phone (202) 682-8319 or email [ehs@api.org](mailto:ehs@api.org).**



# Use of Long-Term Monitoring Data to Evaluate Benzene, MTBE, and TBA Plume Behavior in Groundwater at Retail Gasoline Sites

R. Kamath<sup>1</sup>; J. A. Connor<sup>2</sup>; T. E. McHugh<sup>3</sup>; A. Nemir<sup>4</sup>; M. P. Le<sup>5</sup>; and A. J. Ryan<sup>6</sup>

**Abstract:** Long-term groundwater monitoring data for 48 retail gasoline sites were analyzed to define the characteristics of affected groundwater plumes containing benzene, methyl tert-butyl ether (MTBE), and tert-butyl alcohol (TBA). Results of this analysis were used to determine the observed range and statistical distribution of current plume lengths, plume stability conditions, constituent concentration trends and attenuation rates, and the remediation timeframe for this population of sites. The goal of this evaluation was to characterize plume behavior as observed across a variety of hydrogeologic settings, on the basis of detailed groundwater monitoring records, rather than to define the site-specific factors controlling plume behavior. The results indicate that MTBE plumes in groundwater underlying a majority of these underground storage tank sites that were monitored for five years or longer (1) have significantly diminished in concentration over time, (2) are comparable in length to benzene plumes, (3) are, like benzene plumes, principally stable or shrinking in size and concentration, and (4) are on track to achieve remedial goals within a timeframe comparable to or faster than that of benzene plumes. At these same sites, TBA plumes were found to be comparable to benzene and MTBE plumes in terms of plume length. However, whereas most TBA plumes are also stable or shrinking, the percentage of TBA plumes that are currently stable or shrinking (68%) is less than that for benzene plumes (95%) or MTBE plumes (90%), likely reflecting the temporary build-up of TBA concentrations in groundwater attributable to methyl tert-butyl ether (MTBE) biodegradation. Nevertheless, overall trends for TBA concentrations in groundwater indicate that TBA is attenuating at rates comparable to benzene and MTBE and can be expected to meet applicable remediation goals in a similar timeframe as the other gasoline constituents. DOI: 10.1061/(ASCE)EE.1943-7870.0000488. © 2012 American Society of Civil Engineers.

**CE Database subject headings:** Groundwater pollution; Benzene; Plumes; Remediation; Gasoline.

**Author keywords:** MTBE; Benzene; TBA; Reformulated gasoline; RFG; UST; Groundwater plume behavior; Plume length; Attenuation rate decay rate; Remediation timeframe; Plume stability.

## Introduction

In the 1990s, detections of methyl tert-butyl ether (MTBE) in the groundwater at petroleum storage tank sites and water supply wells generated considerable scientific and regulatory concern regarding the potential effect of this relatively new gasoline fuel additive on groundwater resources [USGS 1995; California Environmental Protection Agency (CEPA) 1999; USGS 2001]. In contrast to non-oxygenated gasoline fuel constituents, MTBE was known to be highly soluble in water, with low sorption coefficients, and was understood to be relatively recalcitrant to natural biological activity (Yeh and Novak 1991; Sufliya and Mormile 1993; Hubbard et al. 1994; Mormile et al. 1994; Neilson 1994). As a result, some scientists predicted that, in comparison with non-MTBE gasoline, releases of MTBE-containing gasoline from underground storage

tank (UST) sites would result in relatively long plumes of affected groundwater that would cause much longer-term effects on groundwater resources and drinking water supplies (Fogg et al. 1998; Odencrantz 1998; Weaver and Small 2002). These predictions were supported by the discovery of a few exceptionally long MTBE plumes extending thousands of feet down-gradient of the release point, such as in Long Island, New York (Weaver et al. 1996; Weaver et al. 1999).

However, studies evaluating actual field measurements of hundreds of MTBE plumes across the United States and abroad have found the true extent and duration of MTBE effects on groundwater to be much less than previously anticipated. Specifically, monitoring data for groundwater plumes at nearly 400 gasoline release sites in California (Happel et al. 1998; Shih et al. 2004), Texas (Mace and Choi 1998; Shorr and Rifai 2002; Rifai et al. 2003), South Carolina (Wilson et al. 2003), and Florida (Reid et al. 1999; Reisinger et al. 2000) show that MTBE plumes typically stabilize at relatively short lengths (< 200 ft), which are comparable to those of benzene plumes. Additionally, groundwater monitoring results from a total of 81 sites evaluated in Texas in 2002 (Shorr and Rifai 2002) and in Florida in 1999 (Reid et al. 1999) indicate that the majority of MTBE plumes (75%) are stable or decreasing in length. Furthermore, with regard to MTBE concentrations in individual monitoring wells, data from a total of 1628 monitoring wells in Texas (Rifai et al. 2003) and Connecticut (Stevens et al. 2006) indicate that MTBE concentrations in the groundwater are stable or decreasing over time in 74% of the wells evaluated. Research outside of the United States similarly reported the effects of MTBE

<sup>1</sup>Environmental Engineer, GSI Environmental Inc., Houston, Texas (corresponding author). E-mail: rkamath@gsi-net.com

<sup>2</sup>President, GSI Environmental Inc., Houston, Texas.

<sup>3</sup>Vice-President, GSI Environmental Inc., Houston, Texas.

<sup>4</sup>Environmental Scientist, GSI Environmental Inc., Houston, Texas.

<sup>5</sup>Environmental Engineer, GSI Environmental Inc., Houston, Texas.

<sup>6</sup>Stanford Univ., Stanford, California.

Note. This manuscript was submitted on November 15, 2010; approved on September 7, 2011; published online on November 4, 2011. Discussion period open until September 1, 2012; separate discussions must be submitted for individual papers. This paper is part of the *Journal of Environmental Engineering*, Vol. 138, No. 4, April 1, 2012. ©ASCE, ISSN 0733-9372/2012/4-458-469/\$25.00.

on potable groundwater sources to be relatively limited on a regional scale. For example, in England and Wales, modeling analyses based on 3,000 groundwater samples from over 800 sites found that the potential plume dimensions for ether oxygenates, such as MTBE, did not pose a major threat to public water supplies (Environment Agency 2000). Additionally, a review of groundwater conditions at a number of sites with exceptionally large MTBE plumes discovered in the 1990s (Fogg et al. 1998; Odencrantz 1998; Weaver and Small 2002) indicate that the MTBE plume length and concentrations have diminished significantly over time [Environmental Assessment & Remediations (EAR) 2005; EAR 2011; New York State Department of Environmental Conservation (NYSDEC) 2011].

Nevertheless, some of these studies indicate that their conclusions may be of limited applicability or certainty owing to the short duration of groundwater monitoring history analyzed for individual sites (< 1 to 3 years) and/or insufficient evaluation of the plume stability condition (Happel et al. 1998; Shih et al. 2004). Employing short-term data to predict long-term plume trends can entail uncertainty because (1) short-term groundwater monitoring data are more vulnerable to seasonal fluctuations and sampling variability; and (2) employing short-term monitoring records could underestimate the true rate of attenuation of compounds, such as MTBE, that require longer acclimation periods to undergo biodegradation. Similarly, characterization of the plume stability condition is important for understanding whether the current plume length represents the maximum area of effect or if further plume expansion could occur.

In addition, recent reports on complex groundwater plumes (e.g., detached and/or diving plumes), such as those located in the Long Island, New York area (Weaver and Wilson 2000; Nichols and Roth 2006), in California (Wilson et al. 2004), in Illinois (Wilson et al. 2005), and in dual-porosity aquifers such as the Cretaceous Chalk in the United Kingdom (Thornton et al. 2006), note the importance of adequate monitoring networks to achieve detailed horizontal and vertical delineation of groundwater plumes at typical UST sites. In the absence of adequate horizontal and vertical delineation, failure to identify detached plumes or diving plume conditions could result in misinterpretation of the groundwater conditions at UST sites, such as underestimation of actual plume lengths. This study evaluates hydrogeologic conditions at each site to identify those sites at which diving plumes may be of concern because of elevated recharge rates, vertical flow gradients, and/or absence of stratigraphic features serving to impede downward plume migration.

The present study attempts to improve the understanding of MTBE plume behavior by (1) evaluating a database of geographically diverse sites with long-term groundwater monitoring records and (2) employing a comprehensive analytical approach that includes evaluation of current plume stability (including the potential for detached and diving plume conditions), current plume length, temporal concentration trends in groundwater, and attenuation rates for MTBE at these sites. In addition to MTBE, the behavior of benzene and tert-butyl alcohol (TBA) plumes in groundwater are evaluated and the long-term behavior of these three constituents in groundwater at these sites are compared. Benzene is used in this study as a representative component of non-MTBE fuel, for which the fate and transport characteristics in groundwater were well defined in prior studies, such as Weidemeier et al. 1999. TBA, an intermediate biodegradation product of MTBE, was shown to biodegrade in both aerobic and anaerobic environments (Zeeb and Weidemeier 2007). Evaluation of these three chemicals in groundwater at petroleum release sites is intended to characterize the

behavior of MTBE relative to that of benzene, and the MTBE degradation product, TBA.

## Methodology

This study was conducted using monitoring records from a database of 48 retail gasoline sites with historical detections of benzene and MTBE in groundwater. For this purpose, long-term monitoring records for UST sites, corresponding to sites with complete records for at least six monitoring wells for five years or more, were solicited from regulatory agencies, energy companies, and environmental consultants. Of an initial population of 54 sites, the number of sites found to meet the screening criteria was 48 for benzene, 48 for MTBE, and 38 for TBA. At each site meeting the minimum data requirements, plume behavior for each constituent was characterized by evaluating the current length, the current stability condition, the temporal concentration trends, the observed attenuation rates, and the timeframe necessary to achieve applicable remediation goals.

The groundwater remediation goals used to define the length of the affected groundwater plumes and evaluate the timeframe to achieve remediation endpoints are as follows: 5  $\mu\text{g/L}$  for benzene, 10  $\mu\text{g/L}$  for MTBE, and 12  $\mu\text{g/L}$  for TBA. For benzene, the remediation goal corresponds to the federal maximum contaminant level (MCL) for drinking water (5  $\mu\text{g/L}$ ), (EPA 2009). For MTBE, the value corresponds to the New York State Department of Environmental Conservation (NYSDEC) groundwater standard for MTBE (10  $\mu\text{g/L}$ ), (NYSDEC 2008) and for TBA, the value corresponds to the California drinking water action goal (12  $\mu\text{g/L}$ ) (RWQCB 2004). The reported laboratory detection limits for groundwater analyses at the 48 sites evaluated in this study were rarely above the concentration limits (benzene = 6%; MTBE = 9%; TBA = 14%), providing an appropriate level of sensitivity to evaluate current compliance with remediation goals.

The following section describes the site database used in this study and the methodology used to evaluate plume behavior at each site.

### *Database of Long-Term Groundwater Monitoring Records for UST Sites*

Key characteristics of the groundwater monitoring database for the 48 sites included in this study are as follows:

- Geographic location: The sites are located in various states in the United States with different histories of MTBE use; specifically, 63% of the sites are in California, 19% in New Jersey 10% in Alaska, 6% in Oregon, and 2% in Nevada. A majority of the sites (82%) are located in California and New Jersey, two states that together, represented 45% of the total MTBE consumption in the United States in 2001 (Lidderdale 2003).
- Current site use: Of the 48 UST sites, 30 are active service stations and 18 are inactive stations or vacant lots with no further potential for releases of gasoline.
- Release history: Available information indicates that underground fuel storage tanks and dispenser islands were principal sources of release of leaded and/or unleaded gasoline at the 48 sites evaluated. More than 70% of the 48 sites have records of releases occurring after 1992 or are active service stations that handled MTBE reformulated gasoline (RFG) after 1992.
- Environmental effects: Non-aqueous phase liquid (NAPL) or sheen was reported in monitoring wells at 34 of the 48 sites. Groundwater impacts were reported to be limited to a shallow aquifer unit at a majority of the sites, with only 6% of the sites reporting effects to more than one aquifer zone.

- Groundwater monitoring program: For the 48 sites included in this study, the median number of groundwater monitoring wells per site is 17, with a median of four wells located in the source area (“source wells”), seven wells located within the plume downgradient of the source (“plume wells”), and six wells located outside of the affected groundwater plume (“delineation wells”). In this study, only wells designated as either source wells or plume wells were used to evaluate plume concentration trends. The median length of time that groundwater monitoring was underway at the 48 sites is 15 years for benzene, 11 years for MTBE, and eight years for TBA. Additionally, for the purpose of calculation of point attenuation rates, only those wells with more than eight years of monitoring data were used.
- Remediation history: For 44 of the 48 sites evaluated in this study, information was available regarding past or on going remedial actions for affected groundwater. In sum, seven sites (16%) were managed only by monitored natural attenuation (MNA); nine sites (20%) were addressed only with NAPL recovery; 13 sites (30%) received some form of active groundwater remediation (e.g., pump and treat, air sparging) without NAPL recovery; and 15 sites (34%) received some form of active groundwater remediation in combination with NAPL recovery.

As indicated by the relatively extensive monitoring well networks, the long groundwater monitoring periods, the past presence of NAPL, and the implementation of active remedies at a majority of the sites in this study, this database is more representative of sites with larger fuel releases and more extensive groundwater impacts as opposed to sites with only minor MTBE effects on groundwater (e.g., with a few monitoring wells showing low- $\mu\text{g/L}$  concentrations of MTBE in groundwater). Consequently, the findings of this study should be understood to pertain to plumes at sites with relatively significant fuel releases and not to sites with de minimis releases of MTBE at which much shorter plume lengths and durations may be observed.

### Evaluation of Groundwater Plume Behavior

For each of the 48 sites in this study, the behavior of the affected groundwater plume was evaluated as follows:

1. Plume stability: The current plume stability condition was characterized by two methods: (1) comparing the maximum spatial extent of the groundwater plume observed historically with the spatial extent observed during the most recent sampling event at the site and (2) evaluating long-term concentration trends in the wells located at the downgradient edge of the plume using the Mann-Kendall statistical method, as described in the MAROS software system [Air Force Center for Environmental Excellence (AFCEE) 2000]. For each constituent, the plumes were then classified as shrinking, stable, expanding, no trend, or detached. Plume concentration trends were characterized using the Mann-Kendall statistical method, as described in Aziz et al. (2003), as follows: (1) an increasing trend refers to a Mann-Kendall result of increasing with a significance level  $> 90\%$ ; (2) a decreasing trend refers to a Mann-Kendall result of decreasing with a significance level  $> 90\%$ ; (3) a stable condition refers to a Mann Kendall result of no trend at a significance level  $> 90\%$  and with a coefficient of variation (COV)  $< 1$  (indicating low degree of variability); and (4) no trend refers to a Mann-Kendall result of no trend but with a significance level  $< 90\%$  and a high degree of variability (COV  $> 1$ ). Using this approach, plume stability was evaluated for benzene at 42 sites, for MTBE at 41 sites, and for TBA at 34 sites.
2. Current measured and estimated plume length: Current plume lengths were determined either by (1) measuring the distance

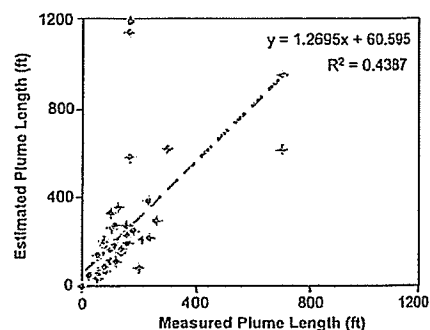

Fig. 1. Correlation between estimated versus measured plume lengths at 30 UST sites with well-delineated MTBE, benzene, and TBA plumes

from the source location to the downgradient location meeting the remediation goal (i.e., a clean location), for those sites in which the existing monitoring well network included at least one clean downgradient well (designated as well-delineated plumes in this study); or (2) estimating the distance from the source to a clean downgradient location, using an empirical estimation method on the basis of the observed bulk attenuation rate (Newell et al. 2002), for those sites at which the current monitoring well network did not include a clean downgradient well. Plumes for which the lengths could not be either directly measured or estimated were designated as indeterminate.

The available data were sufficient to provide measurements of plume length for 26 benzene plumes, 28 MTBE plumes, and 19 TBA plumes. These well-delineated plumes were considered the more reliable measure of plume length and were consequently used to check the plume length estimation method used for plumes with less complete delineation. As shown in Fig. 1, the estimated plume lengths for the well-delineated plumes, derived using the bulk attenuation rate, show a reasonable correlation to the true measured plume lengths at these sites (slope = 1.2,  $R^2 = 0.43$ ), with the error tending toward overestimation of the true plume length in most cases. On this basis, this calculation method was considered a conservative method for estimating the plume length for those sites with less complete delineation. Using this methodology, estimated plume lengths were derived for an additional eight sites for benzene, seven sites for MTBE, and three sites for TBA.

Indeterminate plume lengths were found at 19% of the benzene sites, 15% of the MTBE sites, and 35% of the TBA sites in this study. To account for the effect of these indeterminate lengths on the plume population statistics (specifically, the median plume length), as a highly conservative measure the indeterminate plumes were assumed to be equal to or longer than the longest measured or estimated plume length determined for each constituent.

Additionally, to ensure that the available monitoring data provided a reliable measure of true plume dimensions, at each site and for each constituent the possible occurrence of a diving plume was evaluated on the basis of available data for vertical delineation of the plume. This entailed review of groundwater test results from the deeper monitoring wells on each site to confirm that the plume did not extend downward beyond the depth of the monitoring network, resulting in possible mischaracterization of the true plume length. Furthermore, each site was evaluated using the EPA plume dive calculator (Weaver and Wilson 2000) to determine whether site-specific hydrogeologic conditions could result in downward displacement of the plume

sufficient to extend beyond the depth of the monitoring well network. Results of this analysis found none of the sites to pose a concern with regard to diving plumes. Stratigraphic features at each site may have played an important role in limiting plume dive in the groundwater underlying these sites (Wilson et al. 2005).

3. Current plume concentration trends: To evaluate the long-term temporal trends of constituent concentrations in groundwater at the 48 sites, monitoring data from individual wells that was sampled during eight or more sampling events, with detectable concentrations reported in four or more of these sampling events, were evaluated as follows:

- (1) Concentration trends in individual wells: To assess the trend of concentration versus time within each well, monitoring data from individual wells were statistically evaluated using the Mann-Kendall method, as described in the MAROS software system (AFCEE 2000). Additionally, to minimize the effect of analytical variability and data censoring attributable to the detection limit, only wells in which individual constituents had historically been detected above 20  $\mu\text{g/L}$  were evaluated for concentration trends. Of the 589 source wells and plume wells installed at the 48 sites, 288 wells (43 sites), 306 wells (42 sites), and 241 wells (34 sites) met these minimum criteria for benzene, MTBE, and TBA, respectively.
- (2) Current versus historical compliance with applicable remediation goals: Monitoring data from individual wells that were sampled during at least one event after 2007 were evaluated for past and current compliance with the applicable remediation goals. In total, 218 wells (33 sites), 279 wells (34 sites), and 134 wells (22 sites) met these selection criteria for benzene, MTBE, and TBA, respectively.
- (3) Changes in maximum groundwater concentrations at individual sites over time: Additionally, as a simple measure of the change in plume concentrations over time on a site-wide basis, the maximum historical concentration of each gasoline constituent detected in any well during the initial 20% of the monitoring history at a site was compared with the maximum concentration reported at any well during the most recent sampling event conducted at the site after 2007. At the 48 sites, maximum concentrations of gasoline constituents measured in groundwater ranged between 45  $\mu\text{g/L}$  and 120,000  $\mu\text{g/L}$  for benzene, between 23  $\mu\text{g/L}$  and 1,700,000  $\mu\text{g/L}$  for MTBE, and between 68  $\mu\text{g/L}$  and 700,000  $\mu\text{g/L}$  for TBA. Reduction in maximum groundwater concentrations over time were evaluated at 42 sites for benzene, 41 sites for MTBE, and 34 sites for TBA.

4. Point attenuation rates in individual wells and at sites: A first-order rate of attenuation of chemical concentrations in the groundwater aquifer was calculated for each source well and plume well that exhibited a stable or decreasing concentration trend by estimating the slope of the lognormal plot of concentration versus time [ $\ln C$  versus  $t$ ; point attenuation rate, as defined in Newell et al. (2002)] for benzene, MTBE, and TBA at each well.
5. Additional and total remediation timeframe: For the purpose of this study, the additional remediation timeframe corresponds to the estimated future period required from the date of the last monitoring episode for each site (typically 2009) until the maximum constituent concentration measured at the site is reduced to the applicable remediation goal. This additional timeframe

for each site was calculated using the site-specific average point attenuation rates (see point 4 above) and the most recent maximum concentration for each constituent (Newell et al. 2002). The total remediation timeframe for each compound was calculated as the sum of (1) the duration of groundwater monitoring period following the first detection of the constituent at the site and (2) the maximum estimated additional remediation timeframe necessary to meet the applicable remediation goal for that constituent. Using this approach, additional and total remediation timeframes were evaluated at 37 sites for benzene, 31 sites for MTBE, and 15 sites for TBA.

MTBE-degrading microbes are understood to require longer acclimation periods than the microbes that degrade benzene, toluene, ethylbenzene, and xylene (BTEX) constituents (Shah et al. 2009). Consequently, to avoid underestimating the true rate of biodegradation of MTBE in the groundwater, this evaluation included only those wells with long-term monitoring records ( $> 8$  years) with detectable concentrations of gasoline constituents measured above the detection limit during four or more sampling events. Additionally, to ensure that the observed changes in the concentration were attributable to attenuation rather than an artifact of variable laboratory results or detection limits between sampling events, only those wells that exhibited concentrations above 200  $\mu\text{g/L}$  for each gasoline constituent during the initial 20% of its monitoring history were used to calculate the point attenuation rate for that constituent. Using this approach, point attenuation rates were calculated for 187 wells (38 sites), 165 wells (30 sites), and 62 wells (16 sites) for benzene, MTBE, and TBA, respectively.

The "total remediation timeframe" for each compound was calculated as the sum of (1) the duration of groundwater monitoring period following the first detection of the constituent at the site and (2) the maximum estimated additional remediation timeframe necessary to meet the applicable remediation goal for that constituent. Using this approach, additional and total remediation timeframes were evaluated at 37 sites for benzene, 31 sites for MTBE, and 15 sites for TBA.

## Results of Data Evaluation

### Plume Stability

The results show that the vast majority of the benzene plumes (95%) and the MTBE plumes (90%) evaluated in this study are stable or diminishing in size (see Fig. 2). Less than 5% of benzene

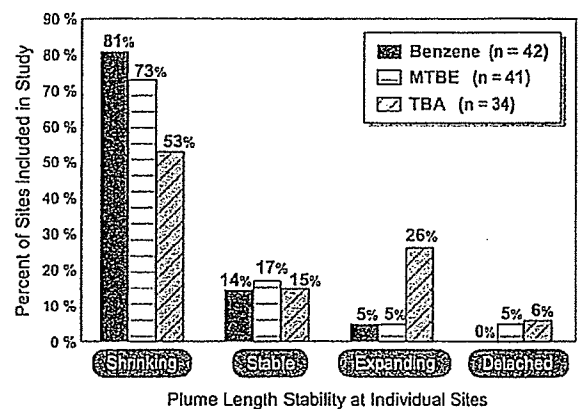

Fig. 2. Results of groundwater plume stability evaluation at individual sites



plumes (2 of 42 sites) and MTBE plumes (2 of 41 sites) were observed to be expanding in size over time. MTBE plumes showed evidence of being detached from the original release area at a small number of sites (2 of 41 sites); however, comparison of the past and current dimensions of these detached MTBE plumes shows that the spatial extent of on-site and off-site groundwater impacts for these detached plumes is also diminishing in size. None of the 42 benzene plumes exhibited detached conditions.

For TBA, 68% of the plumes evaluated (23 of 34 sites) are currently stable or shrinking in size, whereas 26% (9 of 34 sites) were observed to be expanding in size over time. At the remaining two sites (6%), TBA was detected at higher concentrations in the plume wells than in the source wells, indicating a detached plume condition. The higher percentage of expanding TBA plumes (26%) compared with that of its parent compound MTBE (approx. 5%) suggests that, at some sites, biodegradation of MTBE has contributed to increased concentrations of TBA in the areas downgradient of the plume source area.

In summary, in terms of plume stability, MTBE plumes closely match the behavior of benzene plumes, with the vast majority of the MTBE plumes investigated (> 90%) being in a stable or diminishing condition. Additionally, preliminary evaluation of the MTBE footprint at the few sites with detached plumes shows that on-site and off-site groundwater impacts are now much smaller in size than in the past, thus suggesting that, similar to normal groundwater plumes, detached plumes also stabilize and attenuate over time and distance. Although a majority of the observed TBA plumes are also stable or diminishing (68%), the lower percentage relative to MTBE and benzene plumes likely reflects the temporary build-up of TBA concentrations in groundwater attributable to MTBE biodegradation. In general, TBA may persist within the portion of the plume where biodegradation of benzene, MTBE, and other gasoline constituents has depleted available electron acceptors, and then preferentially biodegrade in the downgradient portions of the plume, where higher concentrations of suitable electron acceptors are encountered.

#### Current Measured and Estimated Plume Lengths

For the purpose of this evaluation, plumes lengths were (1) measured directly for well-delineated plumes, (2) estimated using a conservative empirical relationship, or (3) characterized as

indeterminate on the basis of available data (see the discussion in the Methodology section above). Results of the plume length evaluation for each category of plume are provided below and in Fig. 3.

- (1) Measured plume lengths for well-delineated plumes: For sites with well-delineated plumes, the current median plume lengths, as measured by the monitoring well network, are 105 feet for benzene (26 sites), 75 feet for MTBE (28 sites), and 118 feet for TBA (19 sites) [see Fig. 3(a)]. The 90th percentile plume lengths for benzene, MTBE, and TBA at these same sites were 208 ft, 210 ft, and 226 ft, respectively. As a population, no statistically significant difference existed between MTBE plume lengths and benzene plume lengths at the same sites, as determined using the Student's t-test ( $p = 0.69$ ). The two MTBE plumes found to be detached from the source area exhibited plume lengths of 550 ft (with a maximum downgradient extent 700 ft from the original source zone) and 510 ft (with a maximum downgradient extent 885 ft from the original source zone).
- (2) Estimated plume lengths: For sites with stable or shrinking plumes at which the existing well network was not adequate to delineate the plume length but for which a bulk attenuation rate could be calculated (on the basis of a  $\ln C$  versus distance plot), plume lengths were estimated using the method described in Newell et al. (2002) (see the discussion in the Methodology section above). For this population of sites, the current median estimated plume lengths are 354 feet for benzene (eight sites), 379 feet for MTBE (seven sites), and 371 feet for TBA (three sites) [see Fig. 3(b)].
- (3) Measured and estimated plume lengths: In combination, the current median plume lengths were measured or were estimated to be 125 feet for benzene (34 of 42 sites), 110 feet for MTBE (35 of 41 sites), and 145 feet for TBA (22 of 34 sites) [see Fig. 3(c)]. For this data set, the 90th percentile plume lengths for benzene, MTBE, and TBA are 356 ft, 454 ft, and 366 ft, respectively [see Fig. 3(b)].
- (4) Measured, estimated and indeterminate plume lengths: The plume length values presented above do not include indeterminate plumes, for which the plume lengths could not be measured or estimated on the basis of available data, corresponding to 19% of the benzene plumes (8 of 42), 15% of

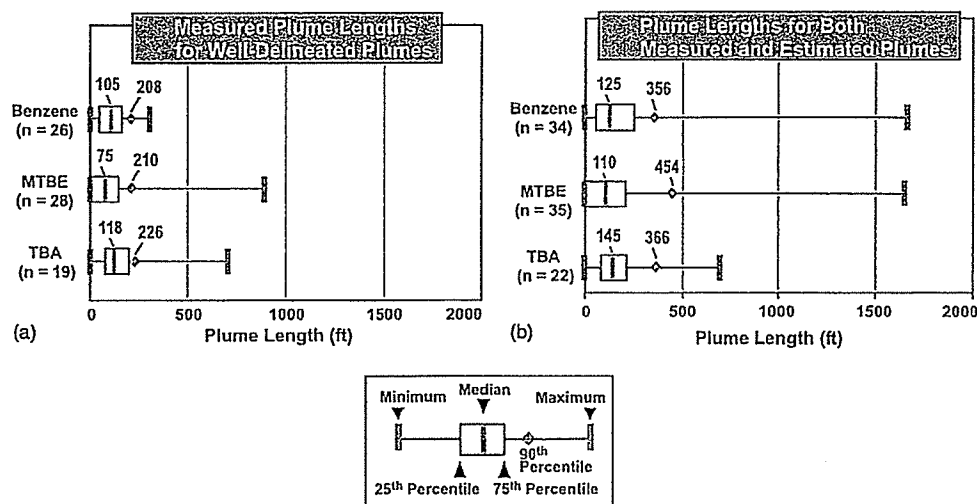

Fig. 3. Distribution of (a) measured plume lengths for well-delineated plumes; (b) measured and estimated plume lengths for all plumes

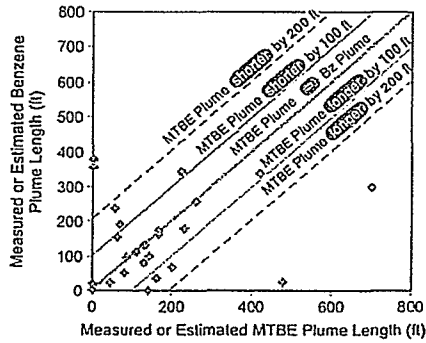

Fig. 4. Comparison of measured or estimated plume lengths for benzene versus MTBE

MTBE plumes (6 of 41), and 35% of TBA plumes (12 of 34) in our data set.

Given that these indeterminate plumes extended beyond the extent of the existing monitoring well networks, expecting that the average length of these plumes would exceed the average length of the plumes whose lengths were delineated or estimated is reasonable. Therefore, as a conservative measure, the median lengths of the full plume population, including the indeterminate plumes, were estimated using highly conservative assumption that all of the indeterminate plumes are equal to or longer than the longest measured or estimated plume length. Given this assumption, the adjusted median plume lengths for the full population of measured, estimated, and indeterminate plumes are 171 feet for benzene, 140 feet for MTBE, and 235 feet for TBA. These values correspond to a very conservative high-end estimate of median plume lengths and may significantly over estimate the true median plume length for this population.

- (5) Comparison of MTBE and benzene plume lengths: On a site-by-site basis, at the 33 sites at which both MTBE and

benzene plumes were measured or estimated, the MTBE and benzene plumes are not statistically different on the basis of a Student's t-test analysis (assuming two-tail distribution and unequal variances between populations;  $p = 0.23$ ). Fig. 4 provides a comparison of the MTBE and benzene plume lengths determined for these 33 sites. As shown, 70% of the MTBE and benzene plumes (23 of 33) are within  $\pm 100$  feet in length, whereas only 12% of sites (4 of 33) contained plumes that differed by more than 200 ft (see Fig. 4).

In summary, for the sites in this study, the lengths of MTBE plumes are comparable to those of benzene plumes (adjusted median values of 140 feet for MTBE versus 171 feet for benzene for all plumes, and unadjusted 90 percentile plume lengths of 454 feet for MTBE versus 356 feet for benzene for measured and estimated plumes). TBA plume lengths are also comparable to those of MTBE plumes (adjusted medians of 235 feet for TBA versus 140 feet for MTBE for all plumes, and unadjusted 90 percentile plume lengths of 366 feet for TBA versus 454 feet for MTBE for measured and estimated plumes).

Note that the applicable MTBE remediation goal employed in this study (i.e.,  $10 \mu\text{g/L}$ ) is more stringent than groundwater standards applied in some states in the United States, including California (primary  $MCL = 13 \mu\text{g/L}$ ) [California Department of Public Health (CDPH) 2009] and New Jersey ( $MCL = 70 \mu\text{g/L}$ ) [New Jersey Department of Environmental Protection (NJDEP) 1997]. Consequently, the plume lengths presented in this paper represent a conservative overestimate of MTBE plume lengths subject to remedial action goals in those states.

#### Current Groundwater Concentrations and Concentration Trends

- (1) Reductions in the maximum plume concentrations observed at each site: The monitoring records show that the maximum plume concentrations recorded within the initial 20% of the monitoring period decreased over time for 93, 90, and 74% of the benzene (40 sites), MTBE (38 sites), and TBA (26 sites) plumes evaluated in this study. Among these sites, the median reductions over time in the maximum historical groundwater concentration were 90%

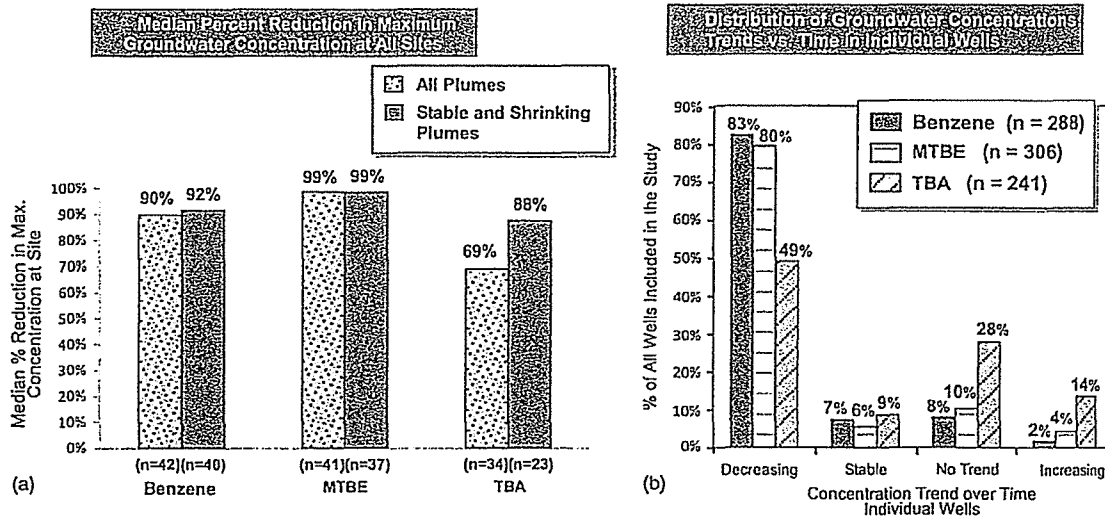

Fig. 5. Concentration Trends: (a) Median percent reduction in maximum groundwater concentration at all sites; (b) distribution of groundwater concentrations trends versus time in individual wells (Both stable plumes and no trend plumes have a Mann-Kendall result of "no trend." However, for our evaluation, consistent with the MAROS guidelines (Aziz et al. 2003), "stable" is used for "no trend" results for which the level of significance is  $> 90\%$  and  $COV < 1$ , whereas no trend refers to no trend results with level of significance  $< 90\%$  and/or  $COV > 1$ )

for benzene, 99% for MTBE, and 69% for TBA [see Fig. 5(a). For those sites with shrinking or stable plumes, the percentage reductions in the maximum historical concentrations were slightly higher than for the full plume population, at 92% for benzene (40 sites), 99% for MTBE (37 sites), and 88% for TBA (23 sites). At sites with detached MTBE plumes (two sites) or TBA plumes (two sites), the concentration reduction was observed to be approximately 92% for MTBE and 81% for TBA.

(2) Concentration Trends in Individual Monitoring Wells: Evaluation of the concentration trends in individual monitoring wells found concentrations to be stable or diminishing over time for 90% of wells with detectable benzene and for 86% of wells with detectable MTBE [see Fig. 5(b)]. Less than 2% of the wells containing benzene and less than 4% of the wells containing MTBE exhibit increasing concentration trends. For TBA, 58% of individual wells show stable or diminishing concentration trends over time, whereas 13% of the wells exhibit increasing trends.

(3) Current versus historical compliance with applicable remediation goals:

All wells: The number of monitoring wells that meet the remediation goals for benzene and MTBE increased significantly over the monitoring periods [see Fig. 7(a)]. Specifically, the percentage of individual monitoring wells that meet the selected remediation goals (i.e., 5  $\mu\text{g/L}$  for benzene and 10  $\mu\text{g/L}$  for MTBE) increased from 10 to 48% for benzene and from 11 to 57% for MTBE, representing an approximate five-fold increase in compliance for each constituent. The percent of individual monitoring wells for which TBA meets the selected remediation goal (12  $\mu\text{g/L}$ ) also increased, but by a lesser margin than the other two constituents, increasing to 25% in the most recent sampling episodes compared with 16% historically, an approximate 60% increase. In general, the percentage of plume wells in compliance with the remediation goal is greater than those located in the source area, which is consistent with the commonly observed pattern of concentrations diminishing more rapidly in the downgradient portion of the plume, with measurable concentrations persisting for a longer period in the source area.

Site-wide evaluation: On a site-wide basis (i.e., in 100% of monitoring wells), 12% of the 43 sites affected by benzene, 24% of the 42 sites affected by MTBE, and 14% of the 35 sites affected with TBA presently meet the applicable remediation goal

for all monitoring wells [see Fig. 6(b)]. Historically, none of these sites met the remediation goal on a site-wide basis for all monitoring wells.

In summary, during the monitoring period, the majority of sites investigated in this study experienced significant reductions in maximum plume concentrations for benzene, MTBE, and TBA (i.e., > 69% of sites for all three compounds). The median reduction observed in the maximum concentration in MTBE plumes (99%) exceeds that of benzene plumes (90%) for the full plume populations [see Fig. 5(a)]. Within individual monitoring wells, MTBE exhibits concentration trends comparable to those of benzene, with 86 to 90% of wells showing stable or diminishing concentrations over time. As a result, a much larger percentage of wells now comply with these remediation goals than was observed at the beginning of the monitoring period. Relative to benzene and MTBE plumes, a smaller percentage of TBA wells (58%) exhibit stable or diminishing concentrations, whereas a larger percentage indicate increasing concentrations (13%), which may reflect the temporary increase in TBA concentrations attributable to biodegradation of MTBE.

Detached MTBE and TBA plumes exhibit concentration reductions (MTBE: 85 to 99% reduction; TBA: 71 to 91% reduction) similar to those of non-detached plumes (MTBE: 29 to 100% reduction; TBA: 11 to 100% reduction). The median concentration reduction exhibited by all TBA plumes (69%) is less than that of MTBE (99%) and benzene plumes (90%), possibly reflecting the temporary build-up of TBA concentrations attributable to biodegradation of MTBE.

#### Point Attenuation Rates in Individual Wells

For wells exhibiting a trend of stable or diminishing concentrations over time, the data are amenable to calculation of a point attenuation rate (i.e., on the basis of  $C$  versus  $t$ ) using the standard methods described in Newell et al. (2002). (Note that, in this paper, when concentrations are declining over time, the rate constant has a negative value; when concentrations are increasing over time, the rate constant is positive). The concentration attenuation rates observed in individual wells for the three gasoline constituents under study are as follows.

- (1) Point attenuation rates in individual wells: First-order point attenuation rates estimated for benzene in 188 wells (39 sites)

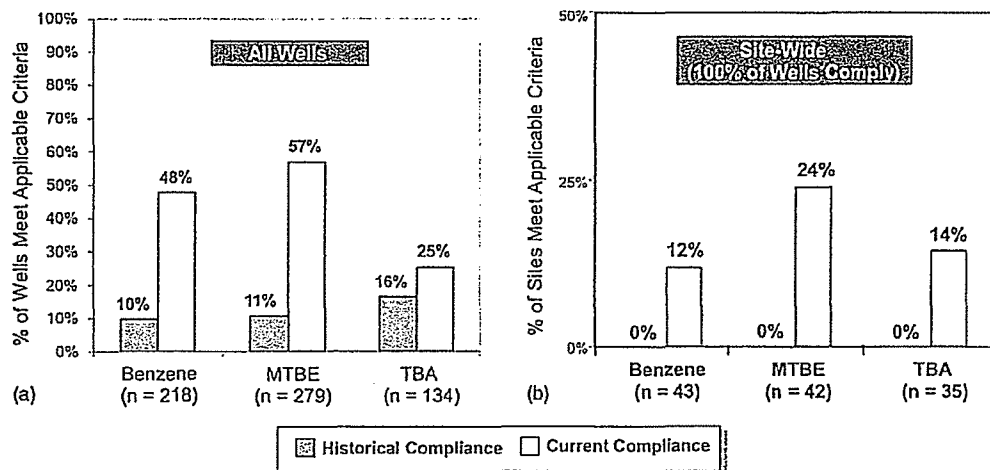

Fig. 6. Comparison of historical versus current compliance with remediation goals

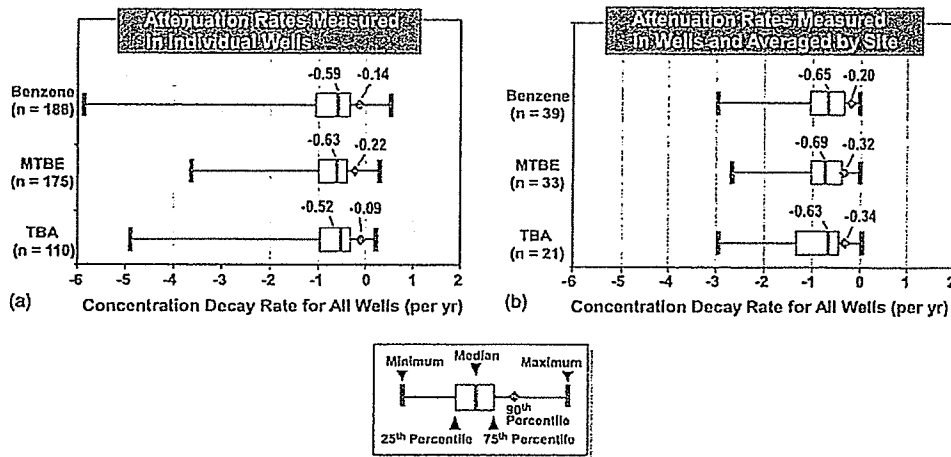

Fig. 7. Comparison of point attenuation rates for benzene, MTBE, and TBA at sites with stable or shrinking plumes

ranged from  $-5.8$  per year to  $0.52$  per year, with a median value of  $-0.59$  per year [see Fig. 7(a)]. For MTBE, first-order attenuation rates were estimated for 175 wells (33 sites) and were observed to range from  $-3.6$  per year to  $0.29$  per year, with a median value of  $-0.63$  per year. TBA degradation rates were estimated for 110 wells (21 sites) and ranged from  $-4.9$  per year to  $1.71$  per year, with a median value of  $-0.52$  per year.

- (2) Median point attenuation rates in wells at each site: Site-wide attenuation rates obtained by calculating the median attenuation rate for individual wells at each site are shown in Fig. 8(b). Attenuation rates ranged between  $-0.12$  and  $-2.9$  per year (median =  $-0.65$  per year) for benzene,  $-2.7$  and  $0.01$  per year (median =  $-0.69$  per year) for MTBE, and  $-2.94$  and  $0.025$  per year (median =  $-0.63$  per year) for TBA. These median attenuation values are comparable, but slightly faster (i.e., more negative), than the values determined for each chemical on the basis the full well population [see Fig. 7(a)].

In summary, concentration trends in individual wells and on a site-wide basis indicate that the point attenuation rates of benzene, MTBE, and TBA are similar

#### Overall Plume Attenuation Rates Based on Trend of Median and Maximum Concentrations among All Sites

As an alternative measure of the relative behavior of benzene, MTBE, and TBA in groundwater, the overall concentration trend for each constituent among the full population of sites was characterized as the change in the median and maximum concentrations versus time among all sites, as shown on Figs. 9(a) and 9(b) and discussed below.

(1) Reduction in overall median concentration versus time for full site population: The median concentrations of benzene, MTBE, and TBA in groundwater for the full site population all decreased significantly over the past 10 years. As indicated in Fig. 8(a), the overall attenuation rates ( $C$  versus  $t$ ) exhibited by these median concentration values over the past 10 years are  $-0.20$  per year,  $-0.47$  per year, and  $-0.27$  per year for benzene, MTBE, and TBA, respectively, corresponding to half lives of 3.4, 1.5, and 2.5 years.

(2) Reduction in maximum concentration versus time for full site population: Similar to the median values, the maximum concentrations of benzene, MTBE, and TBA in groundwater for this site population also decreased significantly over the past 10 years.

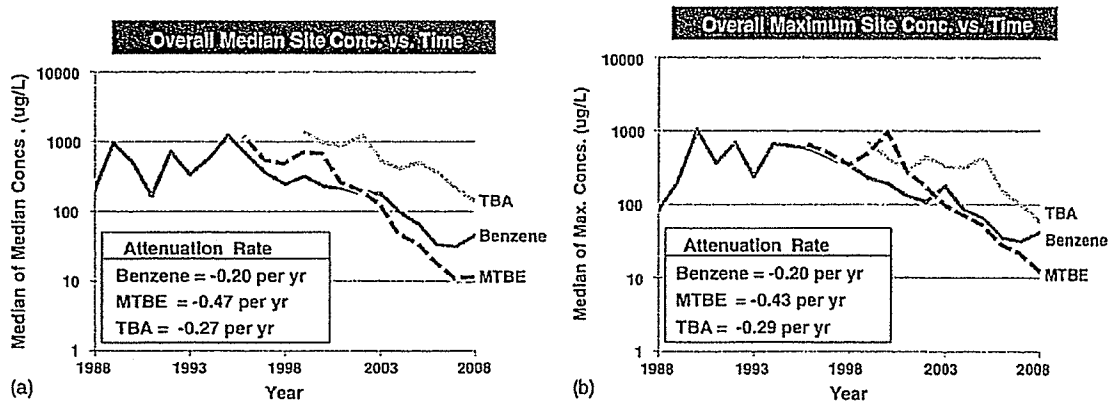

Fig. 8. Trend in site-wide median and maximum plume Concentrations versus time

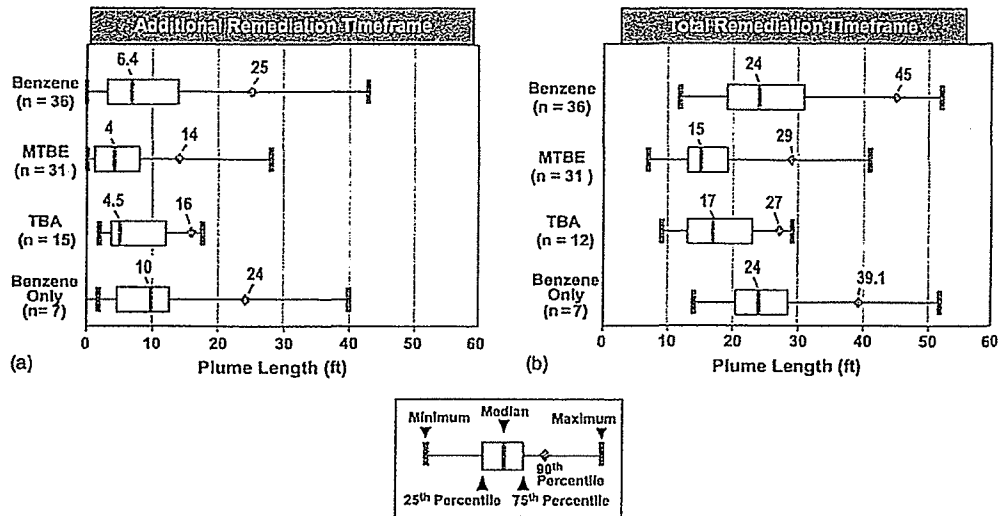

Fig. 9. Time to Remediation for Sites with Stable or Shrinking Plumes ("Benzene Only" refers to those sites where only benzene, not MTBE or TBA, exceeded the applicable remediation goal.)

As indicated in Fig. 8(b), the overall attenuation rates (C versus t) exhibited by these maximum concentration values over the past 10 years are  $-0.20$  per year,  $-0.43$  per year, and  $-0.29$  per year for benzene, MTBE, and TBA, respectively, corresponding to half lives of 3.5, 1.6, and 2.4 years.

In summary, when evaluated on the basis of the full site population, both the median and maximum MTBE concentrations measured in groundwater are observed to decrease at a faster rate than the median and maximum concentrations of benzene. The faster attenuation rate observed for MTBE relative to benzene may reflect the effect of (1) the discontinued use of MTBE in the past decade, as a result of which unlike benzene, additional releases of MTBE cannot occur at active UST sites and/or (2) the much higher solubility of MTBE, compared with benzene, which can result in a more rapid rate of dissolution and depletion of MTBE from the source, eventually resulting in lower contributions of MTBE from the source to the plume, relative to benzene.

The median and maximum TBA concentrations observed for this site population are generally higher than either MTBE or benzene. In addition, TBA exhibits an overall average attenuation rate that is slower than MTBE. These observations are consistent with a temporary build-up of TBA, as a biodegradation product of MTBE, and limited biodegradation of TBA within the more concentrated portions of the plume in which electron acceptors were depleted by preferential biodegradation of BTEX and MTBE.

#### Effect of Active Groundwater Remediation on Plume Attenuation Rates

To evaluate the influence of active remediation on plume concentration trends, attenuation rates at sites at which active groundwater remediation and/or LNAPL recovery were conducted were compared with attenuation rates at those sites that were managed by MNA only. Table 1 summarizes the median attenuation rates determined for sites classified as: (1) MNA only, (2) NAPL recovery only, (3) groundwater remedy only, or (4) groundwater remedy plus NAPL recovery, on the basis of whether such actions were conducted for any period of time in the site history.

Student's t-tests (two-sided) comparing these four groups found that, for all three plume constituents, no statistically significant difference existed between the attenuation rates observed between (1) MNA-only sites versus groundwater remedy only sites (groups 1 and 3 in Table 1; p-value range for the three compounds = 0.10–0.43) or between (2) the combined population of MNA-only plus NAPL recovery only sites (groups 1 and 2 in Table 1) versus the combined population of groundwater remedy only and groundwater remedy with NAPL recovery sites (groups 3 and 4 in Table 1) (p-value range for the three compounds = 0.33–0.62). This analysis indicates that, for this set of sites, active groundwater remedies did not serve to measurably alter the rate of attenuation of plume concentrations versus time for the benzene, MTBE, or TBA. Rather, the fact that groundwater remedy only sites display attenuation rates comparable with those of MNA-only sites suggests that

Table 1. Comparison of Attenuation Rates of Median Plume Concentration versus Time for Different Remedial Action Conditions

Groundwater remediation method	Benzene		MTBE		TBA	
	No. of Sites	Median attenuation rate (1/yr)	No. of sites	Median attenuation rate (1/yr)	No. of sites	Median attenuation rate (1/yr)
1) MNA only	7	$-0.20$	6	$-0.56$	3	$-0.23$
2) NAPL recovery only	9	$-0.13$	9	$-0.42$	7	$-0.18$
3) Groundwater remedy only	13	$-0.27$	14	$-0.47$	12	$-0.24$
4) Groundwater remedy with NAPL recovery	13	$-0.09$	13	$-0.46$	11	$-0.06$

natural attenuation is likely the dominant attenuation mechanism for this population of sites. This observation is supported by the overall trend of TBA and MTBE concentrations across the full population of sites (see point 5 above). The presence of TBA in groundwater at concentrations greater than MTBE similarly indicates that biodegradation of MTBE (i.e., conversion to TBA) is the dominant mass removal mechanism for MTBE and that this natural attenuation process is more significant than active remediation for this site population.

The finding that groundwater plumes at sites managed by MNA only versus sites managed by active groundwater remediation are comparable is consistent with prior investigations of large populations of BTEX plumes (benzene, ethylbenzene, toluene, and xylene), as reported in Newell and Connor (1998). Specifically, studies by Rice et al. (1995) of 208 BTEX plumes in California and by Mace et al. (1997) of 93 BTEX plumes in Texas found no statistical difference in plume lengths between active groundwater remediation sites and MNA only sites.

In summary, the attenuation rates of the median concentrations of the three plume constituents are equivalent for sites in which active groundwater remediation was conducted versus sites in which only MNA was applied. In the absence of more detailed information regarding the remediation activities at each of the sites in this study, particularly with regard to the mass of constituents removed or destroyed, and a comparison of plume conditions before and after the remedy, a degree of uncertainty in this analysis is recognized with respect to the effect of remediation on plume conditions. For example, remediation efforts that remove a significant portion of the source mass from the groundwater can certainly serve to reduce the maximum plume size and increase the rate of plume shrinkage. However, at face value, the similarity of the attenuation rates observed at actively remediated versus nonactively remediated sites suggests that natural attenuation of benzene, MTBE, and TBA may be the principal mechanism of mass removal for this population of plumes.

#### **Additional and Total Remediation Timeframe**

For sites with stable or shrinking plumes, which are amenable to calculation of point attenuation rates ( $C$  versus  $t$ ), the average attenuation rates calculated for each site (see item 4b above) were used to calculate the additional time necessary for the site to meet the applicable groundwater remediation goal [see Fig. 9(a)]. The additional remediation timeframe was estimated to range from 0 to 43 years for benzene (median = 6.4 years for 36 sites), 0 to 28 years for MTBE (median = 4 years for 31 sites), and 2 to 18 years for TBA (median = 4.5 years for 15 sites).

For this same population of sites, the total remediation timeframe was determined as the sum of the additional remediation timeframe plus the number of years since monitoring first began on the site. The total remediation timeframe was estimated to range from 12 to 52 years for benzene (median = 24 years for 36 sites), 7 to 41 years for MTBE (median = 15 years for 31 sites), and 9 to 29 years for TBA [median = 17 years for 15 sites; see Fig. 9(b)]. For sites with MTBE and/or benzene plumes, the combined total timeframe to reach applicable remediation goals is within the range 16 to 53 years, with a median timeframe of 28 years. For sites at which only benzene ever exceeded the applicable remediation goal (i.e., no exceedance for either MTBE or TBA), the total remediation timeframe was estimated to be from 14 to 52 years (median = 24 years; 7 sites).

In summary, evaluation of the additional and total timeframe required to achieve remediation goals again shows benzene and MTBE plumes to exhibit similar behavior. Note that the total remediation timeframes for benzene and/or MTBE plumes

combined (range of 16 to 53 years, with a median timeframe of 28 years) are comparable to the total remediation timeframes for sites at which groundwater impacts are limited to the presence of benzene only, with no MTBE effects above the applicable remediation goal (range of 14 to 52 years, with a median of 24 years). These results indicate that MTBE plumes are not recalcitrant in comparison to benzene plumes; in contrast, they can be expected to attenuate within the same general timeframe. Indeed, as suggested by the data in this study, at many sites, MTBE plumes may be observed to reach remediation goals more quickly than the benzene plume.

#### **Comparison to Previous Studies**

Earlier studies predicted that, in comparison to non-MTBE gasoline, releases of MTBE-containing gasoline from UST sites would result in relatively long plumes and much longer-term effects on groundwater resources (Fogg et al. 1998; Odencrantz 1998; Weaver and Small 2002). However, the results of the evaluation of gasoline plume behavior at 48 sites located in diverse hydrogeologic settings across the nation indicate that at a majority of UST sites that were monitored for five or more years: (1) the MTBE concentrations in groundwater significantly diminished over time, (2) MTBE plume lengths and stability conditions are comparable to benzene plumes, and (3) MTBE plume attenuation is on track to achieve remedial goals within a timeframe comparable to or less than that of benzene plumes. These findings are consistent with other studies that examined monitoring data for large populations of UST sites across the nation and found that the spatial extent and duration of MTBE effects on groundwater resources is much less than previously anticipated (Mace and Choi 1998; Reid et al. 1999; Shorr and Rifai 2002; Rifai et al. 2003; Wilson et al. 2003; Shih et al. 2004; Stevens et al. 2006). Review of our specific findings with regard to those of previous studies is summarized in Table 2 and discussed in further detail below.

1. **Plume stability:** The percentage of stable or shrinking MTBE plumes at the 41 sites evaluated in this study (90%) is toward the upper end of the range of values (50 to 96%) published in previous studies for a total of 81 sites evaluated in Texas in 2002 (Shorr and Rifai 2002) and in Florida in 1999 (Reid et al. 1999). These results suggest that, given the longer monitoring periods that were the focus of the current study and the greater passage of time since the release, a larger percentage of MTBE plumes will attenuate to a stable or shrinking condition.
2. **Plume length:** The median MTBE plume length determined in this study (adjusted upper-end median of 140 feet) is on the lower end of the range of median lengths (140 feet to 178 feet) reported in earlier studies (Mace and Choi 1998; Wilson et al. 2003; Reid et al. 1999). Again, this shorter median plume length may reflect the longer monitoring periods for the sites included in this study, which is consistent with continued attenuation of MTBE plume lengths over time.
3. **Point attenuation rate:** The median attenuation rate for MTBE in groundwater ( $-0.63$  per year) reported for the sites include in this study is faster than the attenuation rate values published in previous studies (median of  $-0.35$  per year) for MTBE-affected sites undergoing natural attenuation only (Schirmer et al. 1999; Wilson and Kolhatkar 2002; Hansen et al. 2003; Rifai et al. 2003; EPA 2005). The faster MTBE attenuation rates observed in this study may reflect the effect of the longer monitoring period, which may provide a more accurate estimate for attenuation rates for compounds, such as MTBE, that entail longer periods for acclimation of the in situ bacterial population.

Table 2. MTBE Plume Characteristics Reported in the Current Study versus that Reported in Literature

MTBE plume characteristic	Results for MTBE plumes					
	Current study		Prior studies of data for multiple plumes		Reference	Comments
	No. of sites	Valuc	No. of sites	Valuc		
Percent of stable or shrinking plume	41	90%	81	50% to 96%	(Shorr and Rifai 2002; Reid et al. 1999)	Results fit within the range of previous findings, but indicate higher % of stable/shrinking plumes.
Plume length (feet)	35	Median = 140 ft <sup>a</sup>	356	Median = 140–178 ft	(Mace and Choi 1998; Wilson et al. 2003; Reid et al. 1999)	The study finds median MTBE plume length to be at lower end of range in prior studies.
Point attenuation rate (per year)	33	–3.6 to 0.29 (Median = –0.63)	100 <sup>b</sup>	–1.2 to –0.15 (Median = –0.35)	(Schirmer et al. 1999; Wilson and Kolhatkar 2002; Hansen et al. 2003; EPA 2005; Rifai et al. 2003)	The study finds MTBE attenuation rates to be faster than previous studies.

<sup>a</sup>Table shows the adjusted median plume length for sites at which plume lengths were either measured, estimated, or considered indeterminate.

<sup>b</sup>Results reported from MNA-only sites.

In addition, given the discontinued use of MTBE as a fuel additive, additional releases of MTBE can no longer occur at active UST sites; therefore, in the absence of such additional source contributions, faster attenuation rates are likely to be observed within the population of existing MTBE plumes (Stevens 2006). Furthermore, the higher solubility of MTBE compared with benzene may contribute to more rapid dissolution and depletion of MTBE from the source, resulting in larger reductions in source contributions of MTBE to the plume over the long term.

## Conclusions

This study addresses the characteristics of benzene, MTBE, and TBA plumes in groundwater for a population of 48 retail service station sites, specifically in terms of plume length, plume stability condition, concentration reduction trends over time, attenuation rates, and the timeframe within which natural attenuation achieved remedial goals for each constituent. The goal of this evaluation was to characterize plume behavior as observed across a variety of hydrogeologic settings on the basis of detailed groundwater monitoring records, rather than to define the site-specific factors controlling plume behavior. The groundwater monitoring data analyzed in this study confirm that, over the long term for this site population, the behavior of MTBE plumes in groundwater is similar to that of benzene plumes with respect to current plume lengths and plume stability trends. However, overall MTBE concentrations are decreasing more quickly than benzene, and may, on average, reach the applicable remediation goals more quickly than benzene plumes. The faster attenuation of MTBE plumes compared with benzene is consistent with the discontinued use of MTBE as a fuel additive.

TBA plumes were also found to be comparable to benzene and MTBE plumes in terms of plume length. However, whereas most TBA plumes are stable or shrinking, the percentage of TBA plumes currently stable or shrinking (68%) is less than that for benzene plumes (95%) and MTBE plumes (90%), likely reflecting the temporary build-up of TBA concentrations in groundwater attributable to MTBE biodegradation. Nevertheless, overall trends for the median and maximum concentrations of TBA in groundwater at these sites indicate that TBA is attenuating at rates somewhat faster

than benzene and can therefore be expected diminish to applicable remediation goals in a similar timeframe as the other gasoline constituents.

## References

- Aziz, J. A., Ling, M., Rifai, H. S., Newell, C. J., and Gonzales, J. R. (2003). "MAROS: A decision support system for optimizing monitoring plans." *Groundwater*, 41(3), 355–367.
- Bono, N. (2005). "Riverhead Water District (NYSDEC Spill #95-04009) ? Analytical Results from Remaining Monitoring Wells." Environmental Assessment & Remediations (EAR), Patchogue, NY.
- California Department of Public Health (CDPH). (2009). *MTBE: Regulations and drinking water monitoring results*, (<http://www.cdph.ca.gov/certific/drinkingwater/Pages/MTBE.aspx>)(Oct. 29, 2009).
- California Environmental Protection Agency (CEPA). (1999). "Public health goal for methyl tert butyl ether (MTBE) in drinking water." *Office of Environmental Health Hazard*, ([http://www.oehha.ca.gov/water/phg/pdf/mtbe\\_f.pdf](http://www.oehha.ca.gov/water/phg/pdf/mtbe_f.pdf)).
- California Regional Water Quality Control Board (RWQCB). (2004). "Beneficial Use-Protective Water Quality Limits for Components of Petroleum-Based Fuels." Rancho Cordova, CA. ([http://www.swrcb.ca.gov/water\\_issues/programs/water\\_quality\\_goals/docs/wq\\_limits\\_for\\_fuels.pdf](http://www.swrcb.ca.gov/water_issues/programs/water_quality_goals/docs/wq_limits_for_fuels.pdf)).
- Environment Agency. (2000). "A review of current MTBE usage and occurrence in groundwater in England and Wales." *Environment Agency R&D Publication 97*, The Stationery Office, London.
- Environmental Assessment & Remediations (EAR). (2011). "Exposure assessment. March 2011, Delta Service Station, South 2nd Street, Lindenhurst, NY, NYSDEC Spill #98-01861." *Environmental Assessment & Remediations*, Patchogue, NY.
- Fogg, G. E. (1998). "Impacts of MTBE on California Groundwater, Health and Environmental Assessment of MTBE." *Rep. to the Governor and Legislature of the State of California as Sponsored by SB 521 4: 101*.
- Hansen, J. S., Fung, D. J., Kang, J. J., and Walling, L. (2003). "Full-scale demonstration of natural attenuation of MTBE. In situ and on-site bioremediation - 2003." *Proc. of the Seventh Int. In Situ and On-Site Bioremediation, Symposium*, Orlando, FL.
- Happel, A. M., Beckenbach, E. H., and Halden, R. U. (1998). "An evaluation of MTBE impacts to California groundwater resources." *Lawrence Livermore National Laboratory: UCRL-AR-130897*.
- Hubbard, C. E., Barker, J. F., O'Hannesin, S. F., Vandegriendt, M., and Gillham, R. W. (1994). "Transport and fate of dissolved methanol, methyl-tert-butyl-ether, and monoaromatic hydrocarbons in a shallow

- sand aquifer." *American Petroleum Institute, Health and Environmental Sciences Dept. (API No. 4601)*, Washington, D.C.
- Lidderdale, T. (2003). "Motor gasoline outlook and state MTBE bans." *Energy Information Administration* (<http://www.eia.doe.gov/emeu/steo/pub/special/mtbeban.html>).
- Mace, R. E., and Choi, W. J. (1998). "The size and behavior of MTBE plumes in Texas." *Proc. of the Petroleum Hydrocarbons and Organic Chemicals in Ground Water—Prevention, Detection, and Remediation Conf.*, Houston, Texas, November 11-13.
- Mace, R. E., Fisher, R. S., Welch, D. M., and Parra, S. P. (1997). *Extent, mass, and duration of hydrocarbon plumes from leaking petroleum storage tank sites in Texas*, Bureau of Economic Geology, University of Texas at Austin, Austin, Texas. Geologic Circular 97-1.
- Monitoring and remediation optimization systems (MAROS) [Computer software]. Air Force Center for Engineering and the Environment (AFCEE), Atlanta, GA.
- Mormile, M. R., Liu, S., and Suffita, J. M. (1994). "Anaerobic biodegradation of gasoline oxygenates: extrapolation of information to multiple sites and redox conditions." *Environ. Sci. Technol.*, 28(9), 1727-1732.
- Neilson, A. H. (1994). *Organic chemicals in the aquatic environment—distribution, persistence and toxicity*, Ann Arbor, MI, Lewis.
- Newell, C. J., and Connor, J. A. (1998). "Characteristics of dissolved petroleum hydrocarbon plumes, results from four studies." *API Soil and Groundwater Bulletin 8, December 1998*, American Petroleum Institute, Washington, D.C. ([www.gsi-net.com](http://www.gsi-net.com)).
- Newell, C., Rifai, H. S., Wilson, J. T., Connor, J. A., Aziz, J. A., and Suarez, M. P. (2002). "Groundwater Issue, calculation and use of first-order rate constants for monitored natural attenuation studies." *Rep. EPA/540/S-02/500*, U.S. Environmental Protection Agency, Washington, D.C.
- New Jersey Department of Environmental Protection (NJDEP). (1997). *Federal and N.J. state primary and secondary drinking-water standards as of November 1996: Water Supply Element. Bureau of Safe Drinking Water*, Trenton, NJ.
- New York State Department of Environmental Conservation (NYSDEC). (2008). "USEPA MTBE pilot project report: Objective 2—investigate potential sources of MTBE contamination on Long Island that could impact water supplies or environmentally sensitive areas." Stony Brook, NY. ([http://www.dec.ny.gov/docs/remediation\\_hudson\\_pdf/mtbepilot1.pdf](http://www.dec.ny.gov/docs/remediation_hudson_pdf/mtbepilot1.pdf)).
- New York State Department of Environmental Conservation (NYSDEC). (2011). *New York State Department of Environmental Conservation (NYSDEC), Spill Incidents Database Search Results for Spill Number 94-04094*, (<http://www.dec.ny.gov/cfm/external/spills/details.cfm?pageid=2>).
- Nichols, E. M., and Roth, T. L. (2006). "Downward solute plume migration: Assessment, significance, and implications for characterization and monitoring of diving plumes." *API Bulletin No. 24, American Petroleum Institute*, Health and Environmental Sciences Department, Washington D.C.
- Odenrantz, J. E. (1998). "Implications of MTBE for intrinsic remediation of underground fuel tank sites." *Remediation J.*, 8(3), 7-16.
- Reid, J. B., Reisinger, H. J., Bartholomae, P. G., Gray, J. C., and Hullman, A. S. (1999). "Comparative MTBE versus benzene plume behavior." *BP Oil Company Facilities*, Florida.
- Reisinger, H. J., Reid, J. B., and Bartholomae, P. J. (2000). "MTBE and benzene plume behavior: A comparative perspective." *Soil, Sediment and Groundwater J., MTBE Special Edition 2000*, 43-46.
- Rice, D. W. et al. (1995). "California leaking underground fuel tank (LUFT) historical case analyses." *Environmental Protection Department, Environmental Protection Division*, Lawrence Livermore National Laboratory, Livermore, CA.
- Rifai, H. S., Shorr, G. L., and Bagga, A. (2003). "MTBE behavior at field sites and plume characterization." *Proc. of the 2003 Petroleum Hydrocarbons and Organic Chemicals in Ground Water/Prevention, Assessment, and Remediation Annual Conf.*, Costa Mesa, CA.
- Schirmer, M., Butler, B. J., Barker, J. F., Church, C. D., and Schirmer, K. (1999). "Evaluation of biodegradation and dispersion as natural attenuation processes of MTBE and benzene at the Borden field site(B)." *Phys. Chem. Earth*, 24(6), 557-560.
- Shah, N. W., Thornton, S. F., Bottrell, S. H., and Spence, M. J. (2009). "Biodegradation potential of MTBE in a fractured chalk aquifer under aerobic conditions in long-term uncontaminated and contaminated aquifer microcosms." *J. Contam. Hydrol.*, 103, 119-133.
- Shih, T., Rong, Y., Harmon, T., and Suffet, M. (2004). "Evaluation of the impact of fuel hydrocarbons and oxygenates on groundwater resources." *Environ. Sci. Technol.*, 38(1), 42-48.
- Shorr, G. L., and Rifai, H. S. (2002). "A closer look at the MTBE behavior within the subsurface." *Proc. of Int. Petroleum Environmental Conf.*, Albuquerque, NM.
- Stevens, G. J., Metcalf, M. J., and Robbins, G. A. (2006). "Evaluation of the effects of the Connecticut ban of MTBE on ground water quality." Dept. of Natural Resources Management and Engineering, Univ. of Connecticut, Storrs, CT.
- Suffita, J. M., and Mormile, M. R. (1993). "Anaerobic degradation of known and potential gasoline oxygenates in the terrestrial subsurface." *Environ. Sci. Technol.*, 27, 976-978.
- Thornton, S. F., Bottrell, S., Pickup, R., Spence, M. J., and Spence, K. (2006). "Processes controlling the natural attenuation of fuel hydrocarbons and MTBE in the UK Chalk aquifer." *CL:AIRE Research Project Rep. RP3. CL:AIRE*, London. ([www.claire.co.uk](http://www.claire.co.uk)).
- U.S. Environmental Protection Agency (EPA). (2005). "Monitored natural attenuation of MTBE as a risk management option at leaking underground storage tanks." *EPA/600/R-04/1790*, Cincinnati, OH.
- U.S. Environmental Protection Agency (EPA). (2009). "National primary drinking water standards." *EPA 816-F-09-004*. (<http://www.epa.gov/safewater/consumer/pdf/mcl.pdf>).
- United States Geological Survey (USGS). (1995). "Occurrence of the gasoline additive MTBE in shallow ground water in urban and agricultural areas." *NAWQA USGS Fact Sheet FS-114-95*, National Water Quality Assessment Program, Department of Interior, Denver, CO.
- United States Geological Survey (USGS). (2001). "Occurrence and distribution of methyl-tert-butyl ether and other volatile organic compounds in drinking water in the Northeast and Mid-Atlantic regions of the United States, 1993-1998." *U.S. Geological Survey Water Resources Investigation Rep. 00-4228*, East Hartford, CT.
- Weaver, J. W., Haas, J. E., and Sosik, C. B. (1996). "Analysis of the gasoline spill at East Patchogue, New York." *Proc. of the ASCE Conf. on Non-aqueous Phase Liquids in the Subsurface Environment*, Assessment and Remediation, Washington, D.C.
- Weaver, J. W., Haas, J. E., and Sosik, C. B. (1999). "Characteristics of gasoline releases in the water table aquifer of Long Island." *National Ground Water Association/American Petroleum Institute conf., 1999, Petroleum Hydrocarbons Conf. and Exposition*, Houston, TX.
- Weaver, J. W., and Small, M. C. (2002). "MTBE: Is a little bit ok?" *proc. 2002 Petroleum Hydrocarbons and Organic Chemicals in Ground Water®: Prevention, Assessment, and Remediation*, National Ground Water Association, Westerville, OH.
- Weaver, J. W., and Wilson, J. T. (2000). "Diving plumes and vertical migration at petroleum hydrocarbon release sites." *LUSTLine Bulletin 36*, November 2000, 12-15.
- Wiedemeier, T. H., Rifai, H. S., Newell, C. J., and Wilson, J. T. (1999). *Natural attenuation of fuels and chlorinated solvents in the subsurface*, John Wiley and Sons, New York.
- Wilson, B. H., Shen, H., Pope, D., and Schemmeling, S. (2003). "Comparison of plume lengths for MTBE and BTEX at 212 South Carolina sites." Amherst, MA, Amherst Scientific Publishers.
- Wilson, J. T., and Kolhatkar, R. (2002). "Role of natural attenuation in life cycle of MTBE plumes." *J. Environ. Eng.*, 128(9), 876-882.
- Wilson, J. T., Ross, R. R., and Acrec, S. (2005). "Using direct push tools to map hydrostratigraphy and predict MTBE plume diving." *Ground Water Monit. Rem.*, 25(3), 93-102.
- Wilson, R. D., Thornton, S. F., and Mackay, D. M. (2004). "Challenges in monitoring the natural attenuation of spatially variable plumes." *Biodegradation*, 15, 359-369.
- Yeh, C. K., and Novak, J. T. (1991). "Anaerobic biodegradation of oxygenates in the subsurface." *Proc. of the Petroleum Hydrocarbons and Organic Chemicals in Groundwater*.
- Zeeb, P., and Wiedemeier, T. H. (2007). "Technical protocol for evaluating the natural attenuation of MTBE." American Petroleum Institute (API) Publication 4761 (May), 1-186.



Copyright of Journal of Environmental Engineering is the property of American Society of Civil Engineers and its content may not be copied or emailed to multiple sites or posted to a listserv without the copyright holder's express written permission. However, users may print, download, or email articles for individual use.

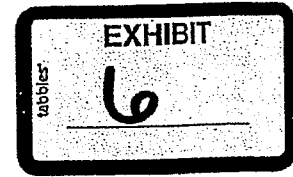

## Review of Quantitative Surveys of the Length and Stability of MTBE, TBA, and Benzene Plumes in Groundwater at UST Sites

by John A. Connor<sup>1</sup>, Roopa Kamath<sup>2</sup>, Kenneth L. Walker<sup>2</sup>, and Thomas E. McHugh<sup>2</sup>

### Abstract

Quantitative information regarding the length and stability condition of groundwater plumes of benzene, methyl tert-butyl ether (MTBE), and tert-butyl alcohol (TBA) has been compiled from thousands of underground storage tank (UST) sites in the United States where gasoline fuel releases have occurred. This paper presents a review and summary of 13 published scientific surveys, of which 10 address benzene and/or MTBE plumes only, and 3 address benzene, MTBE, and TBA plumes. These data show the observed lengths of benzene and MTBE plumes to be relatively consistent among various regions and hydrogeologic settings, with median lengths at a delineation limit of 10  $\mu\text{g/L}$  falling into relatively narrow ranges from 101 to 185 feet for benzene and 110 to 178 feet for MTBE. The observed statistical distributions of MTBE and benzene plumes show the two plume types to be of comparable lengths, with 90th percentile MTBE plume lengths moderately exceeding benzene plume lengths by 16% at a 10- $\mu\text{g/L}$  delineation limit (400 feet vs. 345 feet) and 25% at a 5- $\mu\text{g/L}$  delineation limit (530 feet vs. 425 feet). Stability analyses for benzene and MTBE plumes found 94 and 93% of these plumes, respectively, to be in a nonexpanding condition, and over 91% of individual monitoring wells to exhibit nonincreasing concentration trends. Three published studies addressing TBA found TBA plumes to be of comparable length to MTBE and benzene plumes, with 86% of wells in one study showing nonincreasing concentration trends.

### Introduction

Over the past two decades, thousands of underground storage tank (UST) sites across the United States have been investigated to assess the potential impacts of gasoline fuel leaks on the underlying soil and groundwater. This experience has generated extensive information regarding the nature and extent of groundwater plumes

containing benzene, methyl tert-butyl ether (MTBE), and tert-butyl alcohol (TBA). In the 1990s, when regulations required that gasolines be blended with oxygenate additives like MTBE for more efficient combustion, some researchers predicted that, in the event of a gasoline release to groundwater, MTBE would form much longer groundwater plumes compared to benzene (Fogg et al. 1998; Odencrantz 1998; Weaver and Small 2002). These authors based their predictions upon considerations that (1) MTBE is more soluble and less sorptive than benzene and could therefore travel farther than benzene in groundwater, in the absence of other attenuation mechanisms; and (2) MTBE, unlike benzene, was suspected to be relatively resistant to biodegradation by native soil bacteria (Yeh and Novak 1991; Sufliata and Mormile 1993; Mormile et al. 1994).

These predictions were initially supported by the discovery of a few exceptionally long MTBE plumes extending thousands of feet downgradient of the release

<sup>1</sup>Corresponding author: GSI Environmental Inc., Houston, TX 77098; 713-522-6300; fax: 713-522-8010; jconnor@gsi-net.com

<sup>2</sup>GSI Environmental Inc., Houston, TX 77098.

Received November 2013, accepted May 2014.

© 2014 GSI Environmental Inc. *Groundwater* published by Wiley Periodicals, Inc. on behalf of National Ground Water Association.

This is an open access article under the terms of the Creative Commons Attribution License, which permits use, distribution and reproduction in any medium, provided the original work is properly cited.

doi: 10.1111/gwat.12233

point, such as in Long Island, New York (Weaver et al. 1996, 1999). In contrast to these few exceptionally long plumes, several studies conducted in the mid-1990s that compiled information from numerous UST sites found the measured lengths of benzene and MTBE plumes to be comparable (Happel et al. 1998; Mace and Choi 1998). However, some authors questioned whether these results were reliable, postulating that younger MTBE plumes could be continuing to expand while older benzene plumes might be stable or diminishing in size, and/or noting that proper delineation of plume lengths could be hampered by diving plume conditions or other limitations (Happel et al. 1998; Mace and Choi 1998; Shih et al. 2004).

Subsequent scientific studies have improved our understanding of the lifecycle of contaminant plumes and the behavior of gasoline additives in groundwater. Specifically, field and laboratory investigations have found MTBE to biodegrade in groundwater under both aerobic and anaerobic conditions (Mackay et al. 2001, 2007; Wilson et al. 2002; Gray et al. 2002; McKelvie et al. 2007a). Published studies conducted from 1995 to 2013 have compiled field data from thousands of UST sites across the country, providing information on the measured lengths of MTBE and benzene plumes in groundwater and/or the observed plume stability condition (Rice et al. 1995; Buscheck et al. 1996; Mace et al. 1997; Happel et al. 1998; Reid et al. 1999; Reisinger et al. 2000; Shorr and Rifai 2002; Wilson 2003; Rifai and Rixey 2004; Shih et al. 2004; Stevens et al. 2006; Tarr and Galonski 2007; Kamath et al. 2012). In addition, three studies have addressed the behavior of TBA plumes found in conjunction with MTBE gasoline releases (Shih et al. 2004; Kamath et al. 2012; McHugh et al. 2013).

## Purpose of Review

In this paper, we have reviewed the results of 13 published studies of multiple plumes to characterize the statistical distribution of plume lengths, plume stability conditions, and concentration trends for benzene, MTBE, and TBA plumes at UST sites. These studies have applied a variety of technical criteria and methodologies to achieve a representative measurement of plume lengths and stability conditions at retail gasoline sites. In total, the studies provide quantitative data on over 550 MTBE plumes and over 1300 benzene plumes at retail gasoline sites in a variety of hydrogeologic settings.

This review paper updates prior publications that compiled information on large populations of benzene and MTBE plumes (Newell and Connor 1998) by incorporating the results of additional multi-plume studies conducted over the past 15 years. In addition, this study incorporates the results of three studies that have addressed TBA plume behavior in addition to benzene and MTBE (Shih et al. 2004; Kamath et al. 2012; McHugh et al. 2013). This paper describes the methodology employed to review and compile these data, presents statistical summaries of benzene, MTBE, and TBA plume characteristics, and addresses the significance and limitations of these data.

Compilation of the data from these 13 separate studies is intended to provide a more complete understanding of plume behavior across multiple regions, as well as summary statistics on the observed length and stability condition of these plumes. This review serves to compile information generated over two decades of scientific investigation so as to provide the reader the benefit of the accumulated knowledge and weight of evidence that could not be obtained from the individual studies on their own.

## Compilation of Data from Published Studies

We have surveyed the published literature to identify prior studies that have compiled quantitative data on groundwater plume conditions at multiple UST sites in the United States. Table 1 lists 13 studies that provide quantitative information and statistical summaries regarding the lengths and/or stability conditions of benzene, MTBE, and/or TBA groundwater plumes. Appendix S1 includes summary data from each paper tabulated as the basis for this paper.

### Technical Specifications of Quantitative Surveys of Plume Characteristics

Each of the studies compiled in this paper has employed one or more technical criteria to obtain a representative sampling of plume characteristics from among existing groundwater monitoring records at UST sites. Key considerations include the following:

1. *Nature of Release.* These studies provide information on plume conditions associated with gasoline fuel releases from UST systems, principally retail fuel marketing facilities. Plumes associated with other potential sources of release (pipelines, refineries, tank farms, truck spills, etc.) or materials (diesel fuel, bulk additives, etc.) were not included in these databases.
2. *Survey of Multiple Site Locations.* Each of the studies provides quantitative data on multiple benzene, MTBE, and/or TBA plumes. Individual studies on plume lengths include 22 to 289 sites per study. Studies on plume stability conditions include 34 to 271 sites per study, with one study addressing the overall plume concentration trends observed at over 4000 UST sites in California (McHugh et al. 2013).
3. *Duration of Groundwater Monitoring History.* A number of the studies selected sites with longer-term monitoring periods so as to establish plume trends with less uncertainty associated with seasonal fluctuations, sampling variability, and attenuation rates for compounds, such as MTBE, which have been observed to require longer acclimation periods for biodegradation. For those studies that specified minimum monitoring periods, the minimum monitoring periods required exceeded one year in duration, with most of the studies requiring three or more years.
4. *Number of Groundwater Monitoring Points.* For most of the studies reviewed, plume characterization was based upon a minimum number of three to eight monitoring points per site to define the plume length or

**Table 1**  
**Summary of Studies on Plume Length and Plume Stability Conditions Based upon Data from Multiple UST Sites**

Study	State	No. of Sites Meeting Minimum Specifications	Minimum Specifications for Evaluation Sites	Plume Length Reported?	M, B in Same Wells?	Plume Stability Condition Evaluated?	
						Length Versus Time	GW Conc. Trend
1. Rice et al. (1995)	CA	271	8 events; 6 wells	B (271 sites)	—	B (271 sites)	B (271 sites)
2. Buscheck et al. (1996)	CA	119	NR	BTEX/Benzene (62 sites) <sup>1</sup>	—	—	BTEX (119 sites)
3. Mace et al. (1997)	TX	227	6 wells	B (217 sites) <sup>2</sup>	—	B (217 sites)	B (227 sites)
4. Happel et al. (1998)	CA	63	1 sampling event; 8 wells	M (50 sites), B (50 sites) <sup>3</sup>	Yes (43 sites)	—	—
5. Mace and Choi (1998)	TX	289	Three events (1995–1997)	M (89 sites <sup>4</sup> ), B (289 sites)	—	M, B (20 sites) <sup>5</sup>	M (471 wells)
6. Reid et al. (1999), Reisinger et al. (2000)	FL	55	3 years; Minimum 3 wells with detections MTBE	M (55 sites), B (54 sites)	Yes	M (45 sites)	—
7. Shorr and Rifai (2002), Rifai et al. (2003), Rifai and Rixey (2004)	TX	36	3 years; Minimum 6 wells; Minimum 3 years MTBE data	M (36 sites), B (36 sites)	Yes	M (36 sites), B (36 sites)	M (1074 wells), B (1206 wells) <sup>6</sup>
8. Wilson (2003)	SC	212	NR	M (212 sites), BTEX (212 sites)	Yes	—	—
9. Shih et al. (2004)	CA	96	1 year; sufficient wells; proper lab QA/QC	M (96 sites), B (95 sites), TBA (86 sites)	Yes	M (96 sites), B (94 sites), TBA (86 sites) <sup>7</sup>	—
10. Stevens et al. (2006)	CT	22	4 years; active UST; no NAPL; consistent monitoring program; no active remediation	—	—	—	M (83 wells)
11. Tarr and Galonski (2007)	NH	25	M detections	—	—	—	M (78 wells)
12. Kamath et al. (2012)	CA, NJ, AK, OR, NV	48	Min. 6 wells	M (35 sites), B (34 sites), TBA (22 sites)	Yes, including TBA	M (41 sites), B (42 sites), TBA (34 sites)	M (42 sites, 306 wells), B (43 sites, 288 wells), TBA (34 sites, 241 wells)
13. McHugh et al. (2013)	CA	>4000	2001 to 2011	—	—	—	M (4190 sites) B (4404 sites), TBA (3675 sites)
Total	—	—	—	M (573 sites), B (1320 sites), TBA (108 sites)	474 sites	M (238 sites), B (680 sites), TBA (120 sites)	—

M = Methyl tert-butyl ether (MTBE); B = Benzene; BTEX = Benzene, toluene, ethylbenzene, and xylene; TBA = tert-butyl alcohol; NR = not reported; — = not analyzed; NAPL = nonaqueous phase liquid; QA/QC = quality assurance/quality control; UST = underground storage tank.  
<sup>1</sup>Buscheck et al. (1996) reported the percentage of sites with BTEX plume lengths less than 50 feet, between 50 and 100 feet, between 100 and 200 feet, and greater than 200 feet. The terms BTEX and benzene appear to be used interchangeably within this study.  
<sup>2</sup>Mace and Choi (1998) also presented benzene plume length data, and these data were used to compare with MTBE; Mace et al. (1997) benzene plume length results are not presented in this paper to prevent double-counting the same dataset.  
<sup>3</sup>Benzene plume lengths were estimated based on a 1-µg/L contour limit, inconsistent with the other studies, and therefore could not be used for weighted mean calculations in our paper.  
<sup>4</sup>Mace and Choi (1998) estimated plume lengths at 99 sites, but 10 of these sites had plume lengths of 0 feet.  
<sup>5</sup>Mace and Choi (1998) estimated plume behavior (i.e., plume stability) over time at 20 sites based on plume lengths measured at three different events but did not present the full results of their analysis, and their incomplete results are not analyzed in this paper.  
<sup>6</sup>Shorr and Rifai (2002) only presented the number of wells with near zero or decreasing trends, and their plume stability results are not aggregated in this paper because relative percentages of wells in each trend category were not specified.  
<sup>7</sup>Shih et al. (2004) aggregated the plume length dataset before statistical analysis of plume stability and concluded that while the plume length decreased for MTBE and increased for benzene and TBA, these results were not statistically significant at a 95% confidence interval.

stability condition, with most of these studies requiring six or more monitoring points. The actual number of monitoring wells employed at most sites exceeded this minimum specification, with reported average numbers of monitoring points ranging from approximately 4 to 17 per site.

#### Methodologies for Characterization of Plume Length

The studies reviewed for this paper evaluated plume length based upon a site-by-site evaluation of groundwater monitoring data. Plume lengths were determined based upon measured site data by either of two methods: (1) hand-contouring of the measured concentrations on a scaled map of the sampling locations to the designated concentration limit, or (2) using an empirical or analytical method to estimate the plume length when the existing monitoring well network did not extend downgradient to the specified plume delineation limit. We refer the reader to the individual studies for method particulars.

The prior studies have employed a variety of concentration limits for the purpose of delineating plume length. In our review, based upon consideration of the action levels employed under many state regulatory programs in the United States, we have focused on MTBE and benzene plumes that have been delineated to a 5 or 10 µg/L (micrograms per liter) concentration limit. For benzene, many state agencies employ a 5 µg/L action level (corresponding to the Federal Primary Maximum Contaminant Level [MCL] for benzene in drinking water) for remediation of groundwater that is considered a potential drinking water source. MTBE action levels are generally higher and more variable among state agencies, with levels as low as 5 µg/L applied in California (Secondary MCL for MTBE; CDPH 2006). Evaluation of the plumes delineated to concentration limits of 5 or 10 µg/L provides a conservative basis for characterization of plumes subject to remedial action, as a number of states employ less stringent groundwater cleanup criteria, particularly for MTBE. TBA plumes were evaluated at a 10 µg/L (Shih et al. 2004) and 12 µg/L (Kamath et al. 2012) limit, consistent with California's drinking water notification level of 12 µg/L. Although these contour limits were not identical, the two datasets were combined in this study at an assumed level of 10 µg/L to increase the number of TBA sites, which have been evaluated in far fewer studies than either benzene or MTBE.

#### Methodologies for Classification of Plume Stability Conditions

As defined in prior publications (Rice et al. 1995; Newell and Connor 1998; ASTM 2010), the stability condition of an affected groundwater plume can be characterized according to the following stages (Figure 1):

1. *Expanding Plume*: The plume length and/or concentrations are increasing over time. Commonly observed immediately after the spill material reaches the groundwater and the dissolved chemicals are transported by moving groundwater.

2. *Stable/No Trend Plume*: The plume length and/or concentrations are not changing over time, indicating that the rate at which the dissolved chemical mass is entering the groundwater is balanced by natural attenuation mechanisms, such as dilution, dispersion, sorption, and biodegradation. "Stable" and "No Trend" were considered equivalent designations in a number of the studies. For those papers that distinguished between stable and no trend plumes, both designations indicate the plume concentration to be neither decreasing nor increasing with time; however, the "No Trend" designation entails a higher amplitude of variation (i.e., higher coefficient of variation) than the "Stable" designation.
3. *Shrinking Plume*: The plume length and/or concentrations are diminishing over time, indicating that the rate of mass release from the source area has reduced to the extent that the attenuation factors remove and disperse mass faster than it is entering the groundwater system.
4. *Non-Detect or Exhausted Plume*: In some cases, the affected groundwater zone may diminish to non-detectable levels in the groundwater, while at other sites, the process may slow or terminate in an "exhausted" condition, with trace concentrations of gasoline components remaining near the original source location.

At a given site, measurements can be conducted to determine if a plume is in an expanding, stable, shrinking, or exhausted condition (ASTM 2010). The plume stability condition can be characterized either on the *trend of the plume length* over time or the *trend of plume concentrations* over time in individual monitoring wells.

In the various studies identified on Table 1, the stability of the plume length over time was determined either by: (1) evaluating plume contour maps at different times to determine changes in the length of the plume, or (2) conducting statistical trend analyses on the concentrations measured at monitoring wells, typically located at the downgradient toe of the plume. For the purpose of analysis of plume concentration trends over time, various visual and statistical methods were employed to categorize trends as increasing, decreasing, or stable; we refer the reader to the individual studies for method particulars. While the reports used a variety of methods to characterize plume stability, the similarity of their results points to the consistency of MTBE, benzene, and TBA plume behavior across the various published studies and supports aggregating these results, as done in our study.

#### Statistical Review of Published Studies

To facilitate comparison of the typical lengths of MTBE, benzene, and TBA plumes at UST sites, overall median and 90th percentile plume lengths have been estimated as the weighted mean of the median and 90th percentile values reported in the individual studies. This calculation is based upon the understanding that, for sufficiently large datasets, order statistics, such as the median and 90th percentile values, are normally

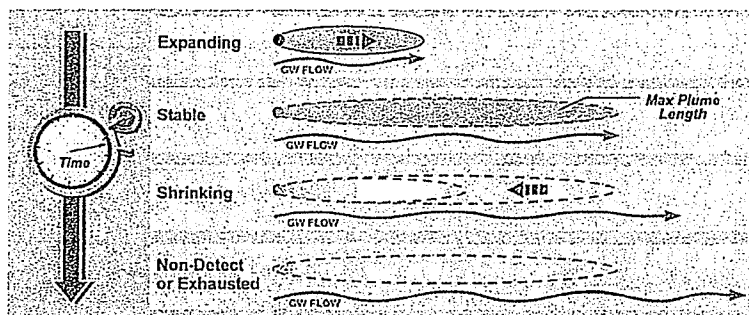

Figure 1. Schematic of groundwater plume stages at a typical UST site following termination of a spill or leak.

distributed, even if the underlying populations are not normally distributed. A weighted mean, based on the number of samples, has been employed to reduce the influence of smaller sample populations, which may exhibit greater variability in order statistics than larger sample populations. In other words, studies with more sites were weighted more heavily than studies with fewer sites. Similarly, the weighted mean approach was utilized to combine the results of the plume stability and concentration trend analyses.

The McHugh et al. (2013) study considered over 4000 UST sites to evaluate the overall trends of the maximum concentrations of MTBE, TBA, and benzene in groundwater over time. They did not address site-specific plume length or stability conditions, but provided important information regarding the net change in chemical concentrations over time in groundwater across these sites. Given the large number of sites they evaluated compared to the other published studies we reviewed, these results were not combined into the concentration trend summary statistics because they would overwhelm the weighted mean calculations; however, the results of McHugh et al. (2013) are compared with the summary statistics in this paper.

### Limitations of These Studies

The authors of the various studies have identified possible limitations in their databases and, when feasible, have employed steps to mitigate the effects of these limitations on their findings. For example, a number of the studies note that, at many UST sites, the affected groundwater plumes are not fully delineated due to access restrictions or other limitations on the number and placement of groundwater sampling points. In addition, some authors note that, if the plume stability condition is not considered, comparison of older, stable plume lengths to younger, expanding plumes could be misleading, as the expanding plumes will not have achieved full length. Some authors also suggest that differences in MTBE and benzene plume lengths could reflect the effect of variable site conditions if the MTBE and benzene plumes are from different sites with distinctly different distributions of key attenuation parameters.

These limitations have been addressed by the authors of the 13 plume studies in a variety of manners. In some studies, plume lengths have been evaluated only for plumes with full delineation, based on a specified minimum number of monitoring points. In other studies, the maximum downgradient extent of the plume has been estimated based upon extrapolation of measured monitoring points, using the method described by Freeze and Cherry (1979) or Newell et al. (2002). Kamath et al. (2012) found this plume length estimation method to provide a reasonably conservative match to measured plume lengths on sites where both measurement and estimation methods were applied. Furthermore, six of the 10 studies that evaluate plume length compare benzene and MTBE plume lengths from the same sites under the same hydrogeologic conditions.

In addition, 11 of the 13 studies have addressed the stability condition of the plumes, providing a basis for determining whether variations in plume age and associated stability condition (e.g., young expanding plume vs. older shrinking plume) could account for observed differences in the lengths of MTBE and benzene plumes. The vast majority of both benzene and MTBE plumes were found to be in a nonexpanding condition, showing that the concern of young versus old plumes is not a factor for plume length. The McHugh et al. (2013) study relied upon the maximum annual concentration of each plume constituent as a conservative basis to track plume concentration trends over time, based upon the consideration that the maximum concentration is likely near the source and therefore less likely to be affected by the extent of plume delineation or the change in the number of monitoring wells over time.

### Findings of Previous Studies

#### Evaluation of Plume Lengths: MTBE, Benzene, and TBA

##### *Statistical Distribution of MTBE, Benzene, and TBA Plume Lengths*

As identified in Table 1, 10 of the 13 published studies address benzene and MTBE plume lengths, providing data on a total of 391 and 132 sites for MTBE plumes at 10

and 5 µg/L delineation limits, respectively, and 826 and 165 sites for benzene plumes at 10 and 5 µg/L delineation limits, respectively. Two published studies also estimated plume lengths for TBA at a total of 108 sites (see Table S1 for tabulated values). Figure 2A and 2B provides side-by-side comparisons of the reported lengths of benzene and MTBE plumes from each of the 13 studies that evaluated plumes at a 5 and 10 µg/L plume delineation limit. Figure 3A and 3B summarize the weighted mean plume dimensions for MTBE, benzene, and TBA at delineation limits of 10 and 5 µg/L, respectively.

#### *Consistency of MTBE and Benzene Plume Lengths Among Various Studies*

The distributions of plume lengths shown in Figure 2 are relatively consistent among studies conducted in a variety of regions in the United States. For example, for plumes delineated to a 10 µg/L concentration limit (see Figure 2A), the median lengths of benzene plumes (826 sites) fall within the range of 101 to 185 feet, while the median lengths of MTBE plumes (391 sites) fall within a slightly narrower range of 110 to 178 feet (Table S1). Similarly, at this same delineation limit, the 90th percentile plume lengths range from 386 to 454 feet for MTBE (336 sites) and 261 to 480 feet for benzene (772 sites; Table S1).

The relatively narrow range of these plume length statistics across hundreds of UST sites suggests that plume lengths are consistent across a broad range of hydro-geologic settings and conditions. This observation is in agreement with prior studies that have found factors such as groundwater hydraulic conductivity and site lithology to be poor predictors of plume length among large numbers of plumes (Reid et al. 1999; Mace et al. 1997; Newell and Connor 1998; Shorr and Rifai 2002; Wilson 2003).

#### *Comparable Lengths of MTBE and Benzene Plumes*

The lengths of the benzene and MTBE plumes reported in the various studies are relatively comparable at both the median and 90th percentile levels, as illustrated by the weighted means of plume length statistics shown in Figure 3. The 90th percentile statistic is of particular interest in this regard as it incorporates the vast majority (90%) of gasoline plumes for which these data have been compiled. At a 10 µg/L delineation limit, the 90th percentile MTBE and benzene plume lengths are 400 feet (336 sites) and 345 feet (772 sites), respectively, showing MTBE plume lengths to be only 16% greater than those of benzene plumes (Figure 3A; Table S1).

At a delineation limit of 5 µg/L, the MTBE and benzene plume lengths are still found to be comparable, although with a moderately more pronounced difference; the 90th percentile MTBE (only evaluated in the Shih et al. 2004 study) and benzene plume lengths are 530 feet (96 sites) and 425 feet (165 sites), respectively, showing MTBE plumes to be 25% longer than benzene plumes (Figure 3B; Table S1). In general, the benzene plume lengths reported in the various studies are consistent with the study by Buscheck et al. (1996) that evaluated 62

UST sites in California and found that 85% of benzene plumes were less than 200 feet long. The Buscheck et al. (1996) study presented a range of plume lengths rather than a statistical distribution and thus could not be directly included in our statistical summary.

In absolute terms, the difference in these MTBE and benzene plume lengths ranges from only 55 to 105 feet (for 90th percentile plume lengths at the 10 and 5 µg/L delineation limits, respectively). The similar plume behavior of benzene and MBTE may reflect their biodegradation characteristics, as both compounds are biodegraded in aerobic groundwater and in most anaerobic geochemical settings.

#### *Exceptionally Long Plumes*

The maximum MTBE plume lengths identified in the studies addressed in this review paper generally fall in the range of 1000 to 1700 feet (see Figure 2). However, other publications have reported longer MTBE plumes (e.g., greater than 2000 feet) at individual UST sites (Weaver et al. 1996, 1999; ESTCP 2003; Thuma et al. 2001; McKelvie et al. 2007b). Consequently, while it is recognized that such exceptionally long MTBE plumes do exist, the small number of such plumes is consistent with the statistical distribution observed in the 13 studies, where MTBE plumes greater than 1400 feet in length correspond to less than 1% of the plume population. Incorporation of this small number of exceptionally long MTBE plumes into the data sets addressed in our review would not affect the weighted means of the median and 90th percentile plume lengths presented on Figure 3.

#### *Lengths of TBA Plumes Compared to MTBE and Benzene Plumes*

Two studies addressed the behavior of TBA plumes in addition to benzene and MTBE (Kamath et al. 2012; Shih et al. 2004) for a total of 108 sites. The weighted mean results from these studies (Figure 3A) indicate that the 90th percentile TBA plume length (420 feet at 10 µg/L; Table S1) is 5% greater than the 90th percentile MTBE plume determined from these and other studies. Similarly, the median TBA plume from the two studies at 10 µg/L is 15% longer than the median MTBE plume determined from a larger number of studies. However, the two studies that addressed TBA (Shih et al. 2004; Kamath et al. 2012) found TBA plume lengths to be comparable to benzene and MTBE plume lengths, with TBA plume lengths falling in between benzene and MTBE plume lengths. Shih et al. (2004) calculated 90th percentile values of the benzene, MTBE, and TBA plume lengths to be 341, 531, and 433 feet, respectively. Kamath et al. (2012) calculated the 90th percentile values of the measured and estimated plume lengths for benzene, MTBE, and TBA to be 356, 454, and 366 feet, respectively. Taken together, the aggregated results and individual studies suggest that TBA plume lengths are similar to MTBE and benzene plumes.

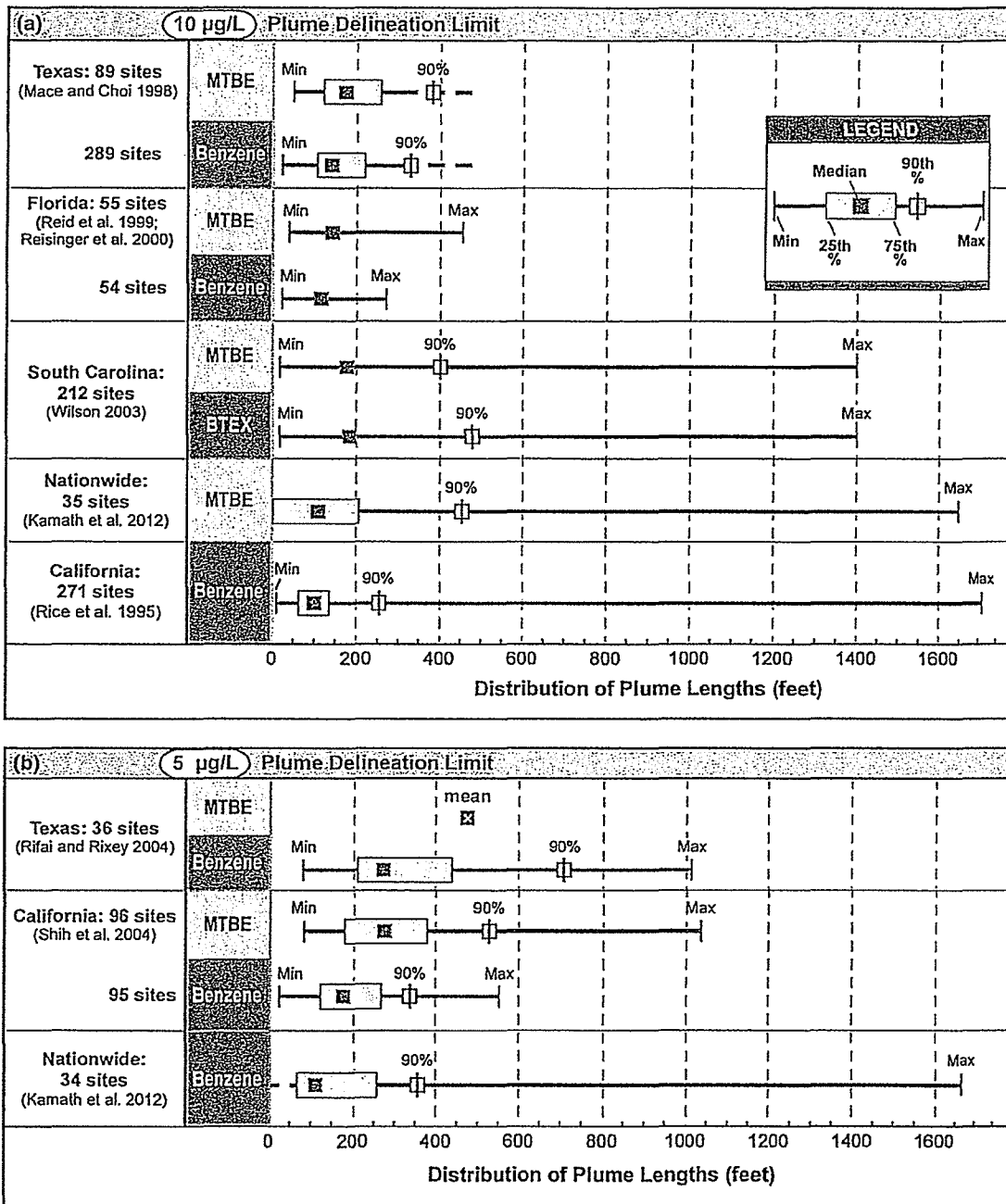

Figure 2. Summary of surveys of plume lengths in groundwater: MTBE versus benzene.

**Evaluation of Plume Stability Conditions: MTBE, Benzene, and TBA**

*Stability Condition of Plume Lengths Over Time*

Five studies have evaluated the stability of plume length over time for a combined 122 sites for MTBE plumes, 566 sites for benzene plumes, and 34 sites for TBA plumes (Reid et al. 1999; Reisinger et al. 2000; Kamath et al. 2012; Shorr and Rifai 2002; Rice et al. 1995; Mace et al. 1997). For each stability category, we

have computed a weighted mean of the percentage of sites falling into that category. Table S2 reports these weighted mean values, as well as the values reported in each study, rounded to the nearest whole number for consistency.

Figure 4 compares the combined plume length trend distributions for MTBE, benzene, and TBA. These studies consistently found that the vast majority of both MTBE and benzene plume lengths are not increasing in length over time. For MTBE plumes, the percent of plume lengths found to be stable, no trend, decreasing, or



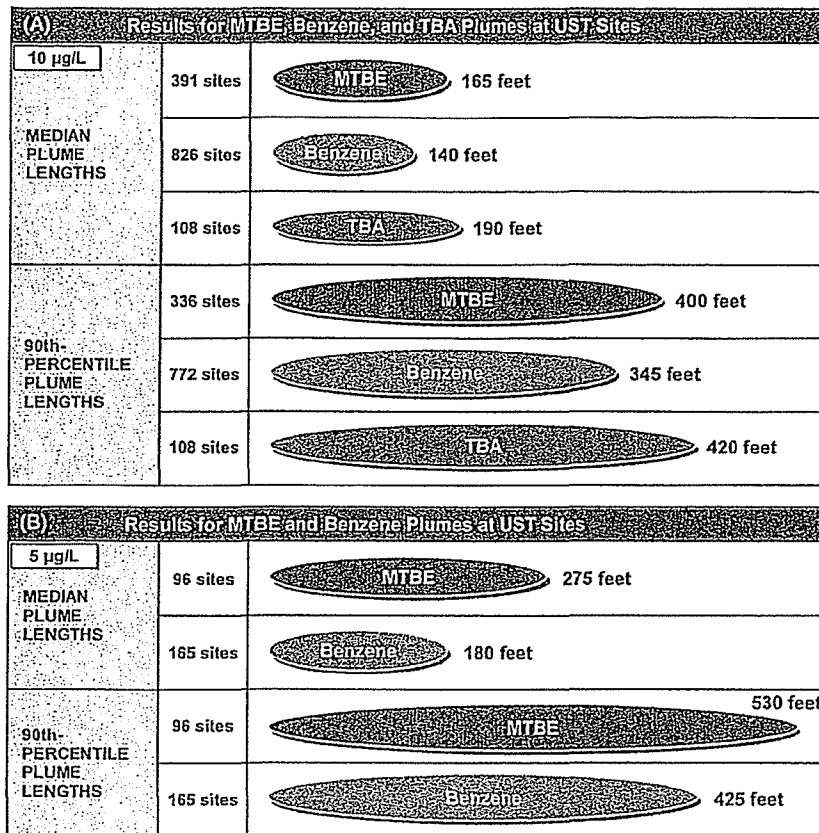

Figure 3. Weighted means of median lengths and 90th percentile lengths of MTBE, TBA, and benzene plumes. (A) Weighted means of plume lengths defined by 10 µg/L concentration limit. (B) Weighted means of plume lengths defined by 5 µg/L concentration limit. Lengths are estimated as the weighted mean of median and 90th percentile plume length values reported in various scientific surveys, rounded to the nearest 5 feet, for plumes delineated to a 10 µg/L concentration limit and 5 µg/L concentration limit. Data have been compiled for MTBE, benzene, and TBA plumes in groundwater underlying UST sites across the nation (see Table S1 for studies used to compile these summary lengths).

exhausted ranges from 90 to 96% among three studies, with the weighted mean percentage of plumes that are nonincreasing equal to 93%. Similarly, for benzene plumes, among four studies, the percent of plume lengths found to be stable, no trend, decreasing, or exhausted ranges from 92 to 97%, with the weighted mean percentage of plumes found to be nonincreasing equal to 94%. The overall percentages of plume lengths observed to be increasing over time is 6% for both MTBE plumes and benzene plumes.

The study by Kamath et al. (2012) specifically addressed the presence of detached MTBE plumes, that is, displacement of the plume mass downgradient from the original source point. They found this condition to occur at only 5% of MTBE sites (2 of 41 sites). Furthermore, these detached plumes were observed to be decreasing in area over time (Kamath et al. 2012). For the purposes of our analysis, the detached plumes were not considered as either increasing or nonincreasing.

Figure 4 also displays the trend distributions for TBA, as determined by Kamath et al. (2012). These data

show that the majority of TBA plumes (68%) are stable or shrinking in length, while 26% are increasing. The percentage of nonincreasing plumes for TBA is lower than for benzene and MTBE (94 and 93%, respectively, are not increasing in length), which may reflect the temporary build-up of TBA concentrations in groundwater following biodegradation of MTBE (Kamath et al. 2012).

#### Concentration Trends in Individual Monitoring Wells Over Time

Seven studies have evaluated concentration trends of benzene and MTBE in individual wells over time (Mace and Choi 1998; Stevens et al. 2006; Tarr and Galonski 2007; Kamath et al. 2012; Buscheck et al. 1996; Rice et al. 1995; Mace et al. 1997), for a combined 938 wells for MTBE and 905 wells for benzene. Kamath et al. (2012) evaluated TBA concentration trends over time in 241 wells. Figure 5 shows the concentration trend distributions for MTBE, benzene, and TBA, with the percentage of plumes falling into each stability category calculated as weighted means among the seven

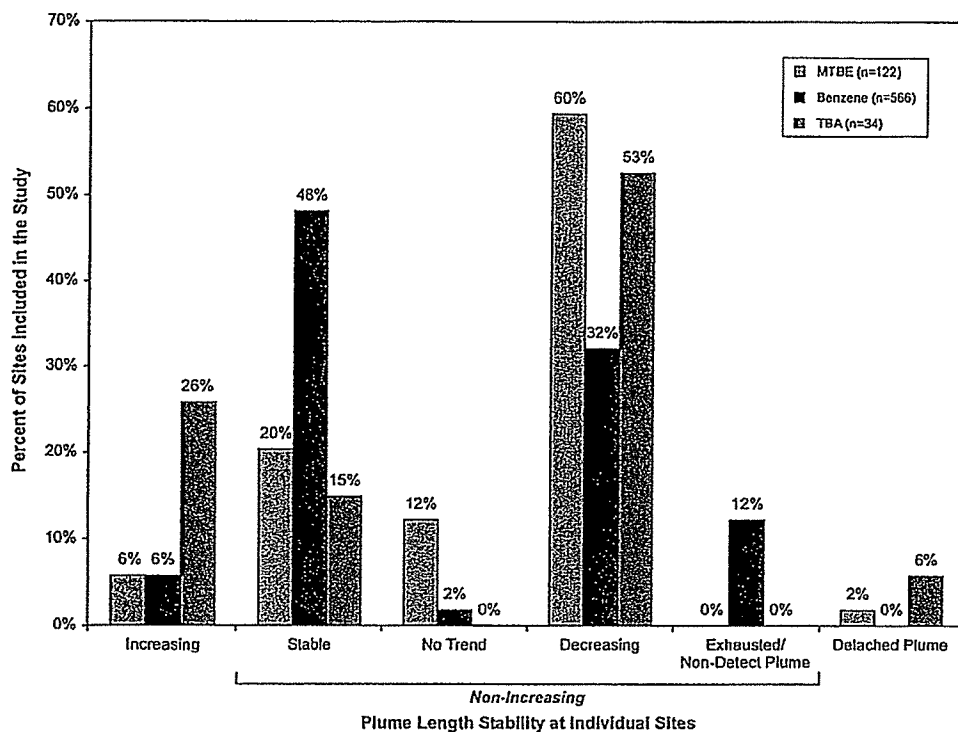

Figure 4. Comparison of plume length stability conditions for MTBE, benzene, and TBA plumes at UST sites. Data have been compiled for MTBE, benzene, and TBA plumes in groundwater underlying UST sites across the nation (see Table S2 for studies used to compile these stability percentages).

studies (see Table S3 for detailed data). In addition to these studies, McHugh et al. (2013) evaluated overall plume concentration trends for MTBE, benzene, and TBA for over 4000 sites in California. The McHugh study addressed the net change in the maximum plume concentrations at each site but did not characterize the plume stability condition per se in the same manner as the other studies; consequently, the weighted means shown on Figure 5 do not include the McHugh et al. (2013) results.

Figure 5 compares the combined distributions of well concentration trends for MTBE (938 wells), benzene (905 wells), and TBA (241 wells). As shown, MTBE and benzene again exhibit similar distributions, with the vast majority of wells showing nonincreasing concentrations over time for both MTBE (91%) and benzene (92%). However, unlike the plume length distribution, a higher percentage of wells exhibit decreasing concentrations for benzene (63%) than for MTBE (45%). Nevertheless, the combined percentage of stable, decreasing, or no trend wells is again comparable for the two compounds, corresponding to 80% of wells for MTBE and 84% of wells for benzene.

Evaluation of TBA concentration trends by Kamath et al. (2012) found stability condition distributions to be roughly comparable to those of benzene and MTBE, with 86% of the wells demonstrating nonincreasing trends. The moderately higher percentage of wells with increasing

TBA concentration trends (14%, compared to 9% and 8% for MTBE and benzene, respectively) may reflect the production of TBA as a by-product of MTBE biodegradation, resulting in temporary replenishment of TBA concentrations until the MTBE source is depleted. Under this scenario, TBA concentrations in turn decrease as the MTBE source mass diminishes and the TBA itself is biodegraded.

Two studies specifically addressed MTBE plume conditions before and after the end of MTBE use as a gasoline additive in Connecticut (Stevens et al. 2006) and New Hampshire (Tarr and Galonski 2007). In both studies, in the 2 years following termination of MTBE use, the percentage of monitoring wells displaying a *decreasing* MTBE concentration trend was observed to increase. In Connecticut, Stevens et al. (2006) found that 93% of the 83 monitoring wells evaluated showed decreasing concentrations of MTBE 2 years after termination of MTBE use. By pooling the monitoring wells across 22 sites, they also determined that 55% of the sites showed a statistically significant decrease in MTBE concentrations between pre- and post-ban data (90th confidence level); only 5% (1 site) showed a statistically significant increase in MTBE concentrations. A similar study of 78 wells in New Hampshire (Tarr and Galonski 2007) reported that, after termination of MTBE use, 85% of monitoring wells exhibited decreasing concentrations, compared to decreasing concentrations at 68% of monitoring wells

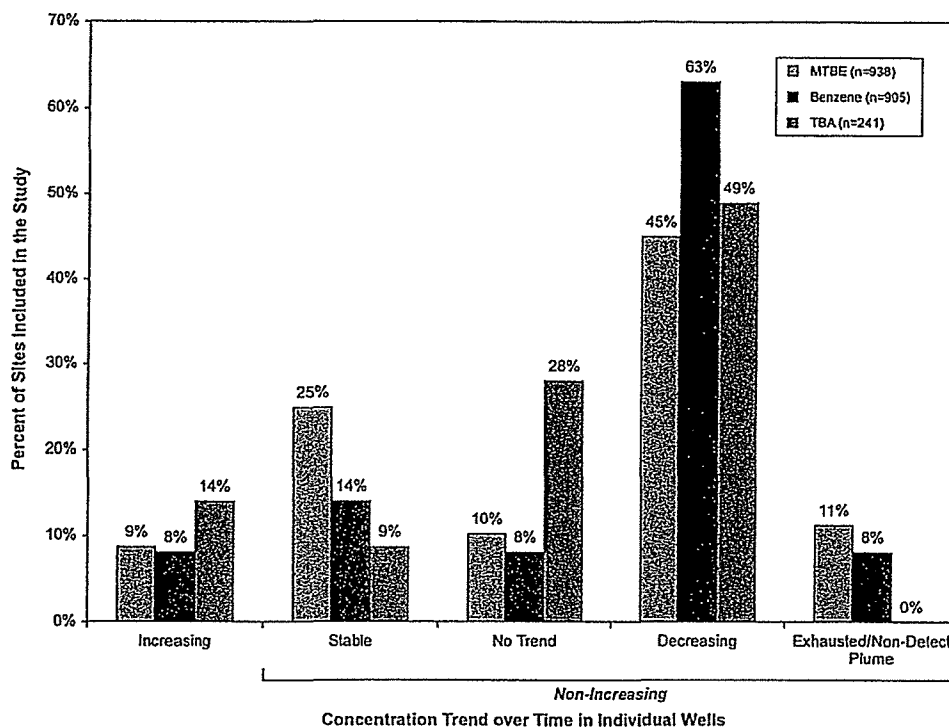

Figure 5. Comparison of concentration versus time trends for MTBE, benzene, and TBA in monitoring wells at UST sites. Data have been compiled for MTBE, benzene, and TBA concentration trends in groundwater underlying UST sites across the nation (see Table S3 for studies used to compile these concentration trends).

prior to the termination of MTBE use in gasoline. These studies demonstrated the decrease in MTBE concentrations with time following termination of MTBE use in these states.

McHugh et al. (2013) compiled data from over 4000 UST sites from the California GeoTracker database to evaluate the overall trends of benzene, MTBE, and TBA concentrations in groundwater over time. These monitoring data showed a large decrease in the groundwater concentrations of gasoline constituents over the period of 2001 to 2011 (85% decrease for benzene, 96% for MTBE, and 87% for TBA), measured as the change in the median of the maximum site concentrations over time. In addition, records of the sites for which continuous monitoring records were available for the full 10-year period (benzene: 1128 sites; MTBE: 1109 sites, TBA: 816 sites) showed benzene and MTBE levels to decrease continuously over this time period, while the maximum concentrations of TBA increased moderately over the period of 2001 to 2004 and then decreased from 2005 to 2011. The study found that the temporary build-up and subsequent decrease of TBA concentrations could be closely matched by a sequential first-order degradation model, which accounted for the generation of TBA as a product of MTBE degradation, followed by the biodegradation of the TBA itself (McHugh et al. 2013).

## Conclusions

In this paper, we have combined the results of 13 previously published studies that surveyed the length and stability condition of affected groundwater plumes associated with releases of gasoline fuels from USTs at numerous service station facilities. These studies combined have addressed over 500 plumes for MTBE, over 1300 plumes for benzene, and 108 plumes for TBA, plus evaluation of concentration trends of all three gasoline constituents over a 10-year period for over 4000 UST sites in California. Employing a variety of approaches, these studies arrive at similar findings with regard to plume length and stability, which suggests that, in combination, these data and the related statistical parameters presented in this review paper provide a reliable characterization of benzene, MTBE, and TBA plume behavior at the majority of UST sites across the United States. Key findings regarding the statistical distribution of plume lengths and plume stability conditions at UST sites include the following:

1. *Comparison of MTBE and Benzene Plumes.* The plume delineation studies show MTBE and benzene plumes to be of comparable length at most sites. For example, at a 10 µg/L delineation limit, the 90th percentile MTBE and benzene plume lengths are 400 feet (336 sites) and 345 feet (772 sites), respectively, a relative difference of 16%. Similarly, at a 5 µg/L delineation limit, the 90th percentile MTBE and benzene plume lengths are

530 feet (96 sites) and 425 feet (165 sites), respectively, a relative difference of 25%, although these values should be considered tentative due to smaller numbers of wells and only one study for MTBE. The vast majority of wells for both MTBE (91%) and benzene (92%) exhibit nonincreasing concentrations over time (i.e., stable, no trend, decreasing, or exhausted), and plume lengths also are predominantly nonincreasing over time for MTBE (93%) and benzene (94%). Consequently, reported plume lengths for benzene and MTBE are likely indicative of their maximum future lengths, as the plumes are generally not increasing in size and concentration.

2. *TBA Plumes Compared to MTBE and Benzene Plumes.* TBA plumes have been found to be of comparable length to benzene and MTBE plumes, with the majority of TBA plumes also nonexpanding (68%), although at a lower percentage than observed for MTBE or benzene plumes (Kamath et al. 2012). At over 4000 sites evaluated, TBA concentration trends over time showed an initial increase, followed by a decreasing concentration at rates comparable to those observed for MTBE and benzene (McHugh et al. 2013).
3. *Consistency Among Various Studies:* The various plume studies, conducted in different geographic regions and in a variety of hydrogeologic regimes, have found plume length statistics to fall into a relatively narrow range, suggesting that hydrogeologic conditions may be less important than other factors (such as the spill volume and biodegradation effects) in defining plume behavior, as has been observed in these and other studies (Reid et al. 1999; Mace et al. 1997; Newell and Connor 1998; Shorr and Rifai 2002; Wilson 2003). Rather, the similar biodegradation characteristics of MTBE and benzene, both of which are degradable in aerobic and most anaerobic geochemical settings, may be responsible for the comparable dimensions and stability conditions of these plumes.

## Supporting Information

Additional Supporting Information may be found in the online version of this article:

Appendix S1. Review of Quantitative Surveys of the Length and Stability of MTBE, TBA, and Benzene Plumes in Groundwater at UST Sites.

Table S1. Statistical plume length data from the literature for MTBE, benzene, and TBA

Table S2. Plume stability results for MTBE, benzene, and TBA

Table S3. Concentration trend results for MTBE, benzene, and TBA

Table S4. Results from Stevens et al. (2006) analysis

## References

ASTM. 2010. Standard Guide for Remediation of Ground Water by Natural Attenuation at Petroleum Release Sites. Designation: E1943-98 (Reapproved 2010), 374–416.

- Buscheck, T.E., D.C. Wickland, and D.L. Kuehne. 1996. Multiple lines of evidence to demonstrate natural attenuation of petroleum hydrocarbons. In *Proceedings of the Petroleum Hydrocarbons and Organic Chemicals in Ground Water*, 445–460, Houston, Texas, National Groundwater Association/American Petroleum Institute, November.
- California Department of Public Health (CDPH). 2006. Secondary Maximum Contaminant Levels and Compliance. California Code of Regulations, Title 22, Division 4: Environmental Health, Chapter 15: Domestic Water Quality and Monitoring Regulations, Article 16, Secondary Water Standards, Section 64449.
- ESTCP. 2003. Technical Report TR-2222-ENV, In Situ Bioremediation of MTBE in Groundwater, ESTCP Project No. CU-0013. Prepared by: Dr. Paul Johnson, Dr. Cristin Bruce, and Karen Miller for the Environmental Security Technology Certification Program and Naval Facilities Engineering Service Center, June.
- Fogg, G.E., M.E. Mays, J.C. Trask, C.T. Green, E.M. LaBolle, T.W. Shenk, and D.E. Rolston. 1998. Impacts of MTBE on California Groundwater. In *Health and Environmental Assessment of MTBE: Report to the Governor and Legislature of the State of California as Sponsored by SB 521*, vol. 4, Ground and Surface Water. 101 pp.
- Freeze, R.A., and J.A. Cherry. 1979. *Groundwater*. Englewood Cliffs, New Jersey: Prentice Hall.
- Gray, J.R., G. Lacrampe-Couloume, D. Gandhi, K.M. Scow, R.D. Wilson, D.M. Mackay, R.D. Wilson, and B. Sherwood Lollar. 2002. Hydrogen isotopic fractionation: A new approach for monitoring biodegradation of methyl tert-butyl ether. *Environmental Science and Technology* 36, no. 9: 1931–1938.
- Happel, A.M., E.H. Beckenbach, and R.U. Halden. 1998. *An Evaluation of MTBE Impacts to California Groundwater Resources*. Lawrence Livermore National Laboratory: UCRL-AR-130897. Report submitted to the California State Water Resources Control Board Underground Storage Tank Program, Department of Energy Office of Fossil Fuels, and the Western States Petroleum Association. 68 pp.
- Kamath, R., J.A. Connor, T.E. McHugh, A. Nemir, M.P. Le, and A.J. Ryan. 2012. Use of long-term monitoring data to evaluate benzene, MTBE, and TBA plume behavior in groundwater at retail gasoline sites. *Journal of Environmental Engineering* 138, no. 4: 458–469.
- Mace, R.E., and W.J. Choi. 1998. The size and behavior of MTBE plumes in Texas. In *Proceedings of the Petroleum Hydrocarbons and Organic Chemicals in Ground Water*, 1–11, November 11–13, Houston, Texas.
- Mace, R.E., R.S. Fisher, D.M. Welch, and S.P. Parra. 1997. *Extent, Mass, and Duration of Hydrocarbon Plumes from Leaking Petroleum Storage Tank Sites in Texas*. Austin, Texas: Bureau of Economic Geology, University of Texas at Austin. Geologic Circular 97-1.
- Mackay, D.M., N.R. de Sieyes, M.D. Einarson, K.P. Feris, A.A. Pappas, I.A. Wood, L. Jacobson, L.G. Justice, M.N. Noske, J.T. Wilson, C.J. Adair, and K.M. Scow. 2007. Impact of ethanol on natural attenuation of MTBE in a normally sulfate-reducing aquifer. *Environmental Science and Technology* 41, no. 6: 2015–2021.
- Mackay, D.M., R.D. Wilson, K.M. Scow, M.D. Einarson, B. Fowler, and I.A. Wood. 2001. In situ remediation of MTBE at Vandenberg Air Force Base, CA. *Contaminated Soil, Sediment & Water*: 43–46.
- McHugh, T.E., P.R. Kulkarni, C.J. Newell, J.A. Connor, and S. Garg. 2013. Progress in remediation of groundwater at petroleum sites in California. *Groundwater* [Epub ahead of print].
- McKelvie, J.R., D. Mackay, N. de Sieyes, G. Lacrampe-Couloume, and B. Sherwood Lollar. 2007a. Quantifying MTBE biodegradation in the Vandenberg Air Force Base

- ethanol release study using stable carbon isotopes. *Journal of Contaminant Hydrology* 94, no. 3–4: 157–165.
- McKelvie, J.R., S.K. Hirschorn, G. Lacrampe-Couloume, J. Lindstrom, J. Braddock, K. Finneran, D. Trego, and B. Sherwood-Lollar. 2007b. Evaluation of TCE and MTBE in situ biodegradation: Integrating stable isotope, metabolic intermediate, and microbial lines of evidence. *Ground Water Monitoring & Remediation* 27, no. 4: 63–73.
- Mormile, M.R., S. Liu, and J.M. Sufliita. 1994. Anaerobic biodegradation of gasoline oxygenates: Extrapolation of information to multiple sites and redox conditions. *Environmental Science and Technology* 28, no. 9: 1727–1732.
- Newell, C.J., and J.A. Connor. 1998. Characteristics of dissolved petroleum hydrocarbon plumes: Results from four studies. American Petroleum Institute Soil and Groundwater Bulletin 8. Washington, DC: American Petroleum Institute.
- Newell, C.J., H.S. Rifai, J.T. Wilson, J.A. Connor, J.A. Aziz, and M.P. Suarez. 2002. Groundwater issue: Calculation and use of first-order rate constants for monitored natural attenuation studies. In EPA/540/S-02/500. Washington, DC: United States Environmental Protection Agency.
- Odenrantz, J.E. 1998. Implications of MTBE for intrinsic remediation of underground fuel tank sites. *Remediation Journal* 8, no. 3: 7–16.
- Reid, J.B., H.J. Reisinger, P.G. Bartholomae, J.C. Gray, and A.S. Hullman. 1999. Comparative MTBE Versus Benzene Plume Behavior. BP Oil Company Florida Facilities. Marietta, Georgia: Integrated Science & Technology, Inc.
- Reisinger, H.J., J.B. Reid, and P.J. Bartholomae. 2000. MTBE and benzene plume behavior: A comparative perspective. *Soil, Sediment and Groundwater Journal*, 43-46.
- Rice, D.W., R.D. Grose, J.C. Michaelsen, B.P. Dooher, D.H. MacQueen, S.J. Cullen, W.E. Kastenber, L.G. Everett, and M.A. Marino. 1995. California Leaking Underground Fuel Tank (LUFT) Historical Case Analyses. UCRL-AR\_122207, Environmental Protection Department, Environmental Restoration Division, Lawrence Livermore National Laboratory, Livermore, California. Submitted to the California State Water Resources Control Board Underground Storage Tank Program and the Senate Bill 1764 Leaking Underground Fuel Tank Advisory Committee.
- Rifai, H.S., and W.G. Rixey, 2004. Final Report: Characterizing the Intrinsic Remediation of MTBE at Field Sites. EPA Grant Number: R828598C791, Subproject 791. [http://cfpub.epa.gov/ncer\\_abstracts/index.cfm/fuseaction/display.abstractDetail/abstract/5882/report/F](http://cfpub.epa.gov/ncer_abstracts/index.cfm/fuseaction/display.abstractDetail/abstract/5882/report/F) (accessed October 21, 2013).
- Rifai, H.S., G.G. Shorr, and A. Bagga. 2003. MTBE behavior at field sites and plume characterization. In *Proceedings of the Petroleum Hydrocarbons and Organic Chemicals in Ground Water*, 138–145, August 19–22, Costa Mesa, California.
- Shih, T., Y. Rong, T. Harmon, and M. Suffet. 2004. Evaluation of the impact of fuel hydrocarbons and oxygenates on groundwater resources. *Environmental Science & Technology* 38, no. 1: 42–48. DOI:10.1021/es0304650.
- Shorr, G.L., and H.S. Rifai. 2002. A closer look at MTBE behavior within the subsurface. In *Proceedings of the International Petroleum Environmental Conference*, October 22–25, Albuquerque, New Mexico.
- Stevens, G.J., M.J. Metcalf, and G.A. Robbins. 2006. *Evaluation of the Effects of the Connecticut Ban of MTBE on Ground Water Quality*. Storrs, Connecticut: Department of Natural Resources Management and Engineering, University of Connecticut.
- Sufliita, J.M., and M.R. Mormile. 1993. Anaerobic biodegradation of known and potential gasoline oxygenates in the terrestrial subsurface. *Environmental Science and Technology* 23, no. 5: 976–978.
- Tarr, J.M., and A.M. Galonski. 2007. MTBE after the Ban. In *Proceedings of the Petroleum Hydrocarbons and Organic Chemicals in Ground Water*, 148, November 5–6, Houston, Texas, National Groundwater Association.
- Thuma, J., G. Hinshalwood, V. Kremesec, and R. Kolhatkar. 2001. Application of ground water fate and transport models to evaluate contaminant mass flux and remedial options for a MTBE plume on Long Island, N.Y. In *Proceedings of the National Ground Water Association Conference: Petroleum Hydrocarbons and Organic Chemicals in Ground Water*, November 14–16. Houston, Texas.
- Weaver, J.W., and M.C. Small. 2002. MTBE: Is a little bit ok? In *Proceedings of the Petroleum Hydrocarbons and Organic Chemicals in Ground Water*, 206–219, November 6–8, Atlanta, Georgia.
- Weaver, J.W., J.E. Haas, and C.B. Sosik. 1999. Characteristics of gasoline releases in the water table aquifer of Long Island. In *Proceedings of the Petroleum Hydrocarbons and Organic Chemicals in Ground Water*, November 17–19, 262, Houston, Texas, National Ground Water Association/American Petroleum Institute.
- Weaver, J.W., J.E. Haas, and J.T. Wilson. 1996. Analysis of the gasoline spill at East Patchogue, New York. In *Proceedings of the American Society of Civil Engineers Conference on Non-Aqueous Phase Liquids in the Subsurface Environment: Assessment and Remediation*, November 12–14, Washington, DC.
- Wilson, B.H. 2003. Comparison of plume lengths for MTBE and BTEX at 212 South Carolina sites. In *MBTE Remediation Handbook*, ed. E.E. Moyer and P.T. Kostecki, 635–638. Amherst, Massachusetts: Amherst Scientific Publishers.
- Wilson, R.D., D.M. Mackay, and K.M. Scow. 2002. In situ MTBE degradation supported by diffusive oxygen release. *Environmental Science and Technology* 36, no. 2: 190–199.
- Yeh, C.K., and J.T. Novak. 1991. Anaerobic biodegradation of oxygenates in the subsurface. In *Proceedings of the Petroleum Hydrocarbons and Organic Chemicals in Ground Water*, 427–441, Houston, Texas, National Ground Water Association/American Petroleum Institute.

## FORUM

# A Comparison of Benzene and Toluene Plume Lengths for Sites Contaminated with Regular vs. Ethanol-Amended Gasoline

by G.M.L. Ruiz-Aguilar, K. O'Reilly, and P.J.J. Alvarez

## Abstract

This article describes various statistical analyses of plume-length data to evaluate the hypothesis that the presence of ethanol in gasoline may hinder the natural attenuation of hydrocarbon releases. Plume dimensions were determined for gasoline-contaminated sites to evaluate the effect of ethanol on benzene and toluene plume lengths. Data from 217 sites in Iowa (without ethanol; set 1) were compared to data from 29 sites in Kansas that were contaminated by ethanol-amended gasoline (10% ethanol by volume; set 2). The data were log-normally distributed, with mean benzene plume lengths ( $\pm$  standard deviation) of  $193 \pm 135$  feet for set 1 and  $263 \pm 103$  feet for set 2 (36% longer). The median lengths were 156 feet and 263 feet (69% longer), respectively. Mean toluene plume lengths were  $185 \pm 131$  feet for set 1 and  $211 \pm 99$  feet for set 2 (14% longer), and the median lengths were 158 feet and 219 feet (39% longer), respectively. Thus, ethanol-containing BTEX plumes were significantly longer for benzene ( $p < 0.05$ ), but not for toluene. A Wilcoxon signed rank test showed that toluene plumes were generally shorter than benzene plumes, which suggests that toluene was attenuated to a greater extent than benzene. This trend was more pronounced for set 2 (with ethanol), which may reflect that benzene attenuation is more sensitive to the depletion of electron acceptors caused by ethanol degradation. These results support the hypothesis that the presence of ethanol in gasoline can lead to longer benzene plumes. The importance of this effect, however, is probably site-specific, largely depending on the release scenario and the available electron acceptor pool.

## Introduction

The use of ethanol as a gasoline additive is likely to increase in the near future as a substitute for the oxygenate MtBE (Powers et al. 2001a, 2001b). Regulatory renewable fuel requirements will also lead to additional ethanol use. Therefore, it is important to understand how ethanol affects the fate and transport of hydrocarbons in ground water. Previous laboratory studies have shown that the presence of ethanol could have undesirable effects on the biodegradation of BTEX (i.e., benzene, toluene, ethylbenzene, and *ortho*-, *para*-, and *meta*-xylene). Specifically, ethanol is often degraded preferentially and contributes to the depletion of nutrients and electron acceptors (e.g.,  $O_2$ ) that would otherwise be available to support BTEX biodegradation (Corseuil et al. 1998; da Silva and Alvarez 2002; Ruiz-Aguilar et al. 2002). In addition, high ethanol concentrations ( $>10\%$ ), which could occur initially at the source, could also enhance BTEX solubility and decrease sorption-related retardation, enhancing hydrocarbon migration (da Silva and Alvarez 2002; Powers et al. 2001b; Rao et al. 1990). These findings suggest that ethanol may hinder BTEX natural attenuation, which could result in longer BTEX plumes

and a greater risk of exposure. Nevertheless, little is known about the magnitude and significance of this potential plume-elongation effect.

Plume dimensions and stability are important parameters to characterize for risk management because they determine the area of influence and the potential duration of exposure. Several investigators have developed mathematical models for predicting the effect of ethanol (added to gasoline at 10% by volume) on BTEX plume length (Table 1). These screening models predict that ethanol would increase the maximum BTEX plume length (i.e., when steady state is reached) by anywhere from  $\sim 10\%$  to 150%. Whereas these models provide valuable insight into the potential ground water impacts of ethanol in gasoline, they are based on simplifying and influential assumptions and have not yet been validated with field data. Therefore, there is a need for empirical evaluations of the effect of ethanol on BTEX plume length.

This article describes statistical analyses of plume-length data to evaluate the general hypothesis that the presence of ethanol in gasoline hinders the natural attenuation of hydrocarbons, resulting in longer BTEX plumes compared to reg-

EXHIBIT

7

tabbles

**Table 1**  
Modeling Efforts to Assess the Effect of Ethanol on Benzene Plume Length

Citation	Conceptual Model	Increase in Benzene Plume Length
Heermann and Powers (1996)	2-D transport from a pool of gasoline. Focus on cosolvency and interface mass transfer. Biodegradation not included.	$\leq + 10\%$ (for xylene not benzene)
Malcom Pirnie Inc. (1998)	Steady-State, 2-D transport from a gasoline pool. First-order decay of benzene when $C_{EtOH} < 3 \text{ mg l}^{-1}$ . First-order decay of ethanol.	+ 17-34 %
McNab et al. (1999)	3-D aqueous transport. Continuous slow release of gasoline (up to 3 gpd) to a growing NAPL pool at the water table. First-order decay of ethanol and benzene. Benzene degradation rate constant defined by inverse correlation to BOD conc. at the source.	$\sim + 100\%$
Molson et al. (2002)	3-D transport from a gasoline source at the water table at a residual saturation. Aerobic decay with $O_2$ as the sole electron acceptor quantified by Monod kinetics. Microbial growth incorporated.	+ 10-150 %

ular-gasoline releases. This article also addresses the likelihood that ethanol would hinder the natural attenuation of benzene to a greater extent than toluene due to differences in their biodegradability under the strictly anaerobic conditions induced by ethanol.

## Methodology

### Plume Data

Two sets of ground water data were collected from about 600 gasoline-contaminated sites. One of the data sets (set 1) was obtained from the Iowa Department of Natural Resources, Underground Storage Tanks Section (IDNR TIER-2 database). This database contained no information about the presence of ethanol; thus, the data were screened to exclude sites with suspected contamination by ethanol-amended gasoline. A review of site investigation reports and telephone surveys were conducted for this purpose. Many of the set 1 sites were also discarded because of insufficient data to plot the required plume contours (e.g., plumes not bracketed by downgradient wells) or because contamination resulted from multiple sources (e.g., overlapping plumes). Therefore, only 217 Iowa sites (contaminated with regular gasoline) were included in set 1. The other data set (set 2) was obtained from the Kansas Department of the Environment and Health (KDEH), and corresponded to 29 sites contaminated with gasohol (i.e., gasoline with 10% ethanol by volume). Site investigation reports did not show salient differences between the two data sets regarding release and response scenario (e.g., amount released, age of spill, or remedial activities). None of these sites reported MTBE contamination. In addition, MTBE is unlikely to affect BTEX or ethanol degradation in contaminated aquifers

(da Silva and Alvarez 2002; Deeb et al. 2001; Ruiz-Aguilar et al. 2002). Thus, MTBE was not a factor in this study.

### Determination of Plume Lengths

Benzene and toluene plume lengths were determined by contouring data from monitoring wells (which were typically separated by about 100 feet), using a computer algorithm based on Hardy's multiquadric method for plotting two-dimensional concentration contours (Saunderson 1994). This algorithm was incorporated into the Iowa RBCA TIER2 Interpolation Program version 2.17, which interfaces with the IDNR TIER-2 database. This approach eliminated subjectivity associated with drawing the plumes by hand. Selected computer-generated plumes were compared to the corresponding hand-drawn plumes for validation purposes. Plume lengths were then measured as the longest distance between the identified source and the  $5 \mu\text{g/L}$  contour, which corresponds to the drinking water standard for benzene.

### Statistical Analyses

Plume length data were imported into Minitab (version 13.1, State College, Pennsylvania), which was used to calculate population statistics for each data set. These statistics included the population mean, standard deviation, median, maximum, and minimum. Distribution analyses were performed using the Anderson-Darling test for log-normality at the 95% significance level (Freedman et al. 1998). A Kruskal-Wallis test was also performed to determine whether BTEX plumes were significantly longer in set 2 (with ethanol) than in set 1 (without ethanol). This nonparametric test, which ranks plume lengths from low to high and then analyzes the ranks (Lehmann 1975), is very robust to test differences in population medians (Johnson and Mizoguchi 1978). Two-sample

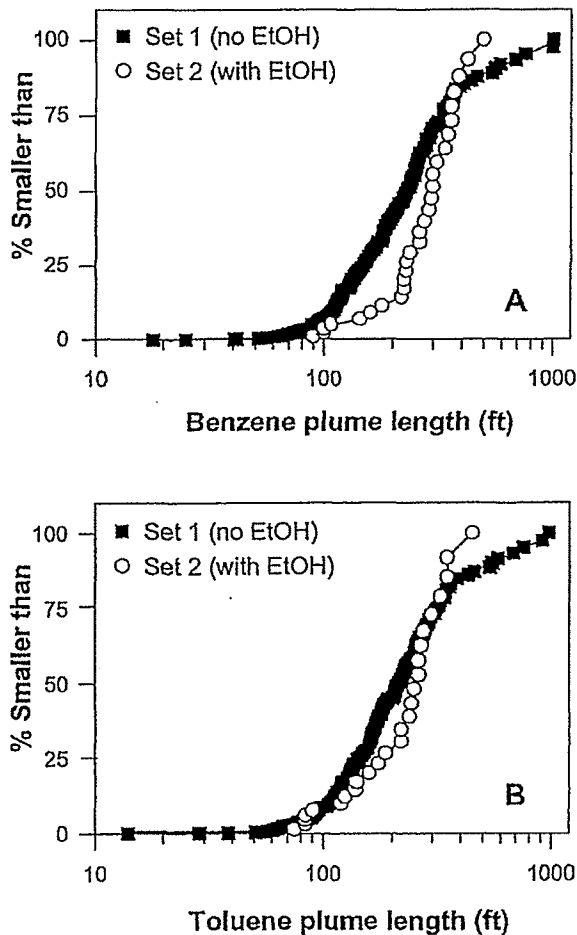

Figure 1. Cumulative distribution of (a) benzene and (b) toluene plume lengths for set 1 (Iowa data, without ethanol) and set 2 (Kansas data, with ethanol).

Student's t-tests (Freedman et al. 1998) were also performed to determine if average benzene and toluene plume lengths were significantly different between the two data sets. Finally, a Wilcoxon signed-rank test was performed to test if benzene plumes were generally longer than toluene plumes, and to determine if this trend was statistically significant.

## Results and Discussion

Plume length data were log-normally distributed ( $p = 0.275$  for benzene and  $0.394$  for toluene) according to an Anderson-Darling test. The cumulative distribution of the plume lengths shows that benzene plumes were generally longer for set 2 (with ethanol) than for set 1 (without ethanol) (Figure 1a). For example, 92% of benzene plumes in set 2 were longer than 150 feet, compared to only 74% for set 1. The same trend was observed for plumes longer than 250 feet. In this case, 69% of benzene plumes in set 2 were longer than 250 feet, compared to 45% for set 1. However, none of the 29 plumes in set 2 was longer than 500 feet, compared to 12% of the 217

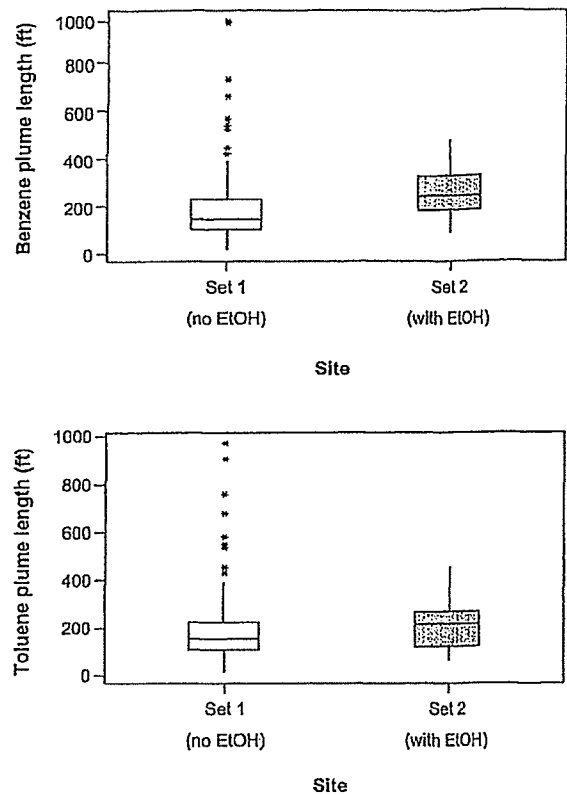

Figure 2. Box plots of the benzene and toluene plume length data. The line across the box represents the median. The bottom and top of the box represent the first and third quartiles (Q1 and Q3). The whiskers extend to the lowest and highest observations inside the region defined by  $Q1 - 1.5(Q3 - Q1)$  and  $Q3 + 1.5(Q3 - Q1)$ . Individual points with values outside these limits (outliers) are plotted with asterisks.

plumes in set 1. This trend reversal reflects that set 1 was a much larger data set and contained both the smallest and largest plumes. Note that these longer plumes are statistical outliers, as determined by the Tukey method (Tukey 1977; Figure 2). Similar results were observed for toluene, although the apparent elongation effect of ethanol was not as pronounced (Figure 1b).

Box plots corroborated that BTEX plumes with ethanol (set 2) were generally longer than those from set 1, without ethanol (Figure 2). A Kruskal-Wallis test showed that the median length of benzene plumes was significantly longer for set 2 than for set 1 (263 versus 156 ft  $p < 0.001$ ; Figure 3). On the other hand, the difference for toluene plumes was not statistically significant (219 versus 158 feet,  $p = 0.073$ ). Note that the median length for benzene and toluene plumes without ethanol is within 15% of that reported by Newell and Connor (1998) (i.e., 132 feet). This value was obtained from a compilation of four surveys (Groundwater Services 1997; Mace et al. 1997; Rice et al. 1995; Newell and Connor 1990), covering a total of 604 sites presumably contaminated with gasoline without ethanol.



Table 2 Summary Statistics for Benzene and Toluene Plume Length Data				
Parameters	Compound			
	Benzene		Toluene	
	Set 1 (no EtOH)	Set 2 (with EtOH)	Set 1 (no EtOH)	Set 2 (with EtOH)
Number of sites	217	29	211	26
Minimum (ft)	18	90	14	75
Median (ft)	156	263	158	219
Maximum (ft)	1005	500	973	450
Mean (ft) ± Std. deviation	193 ± 135	263 ± 103	185 ± 131	211 ± 99
p - value	0.002*		0.243	

\*Data were significantly different ( $p < 0.05$ ) as determined by a two-sample student's t-test.

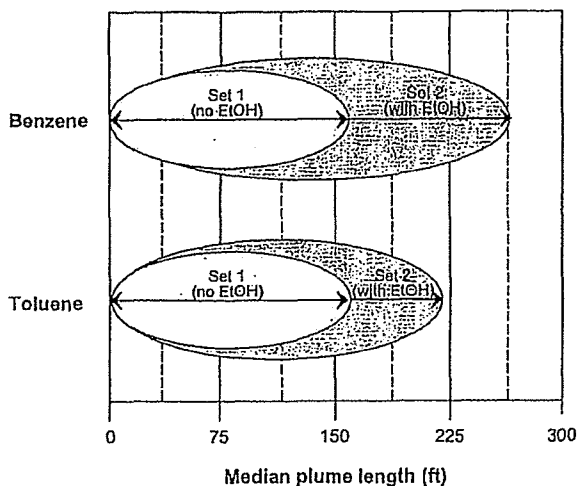

Figure 3. Median length of set 1 (Iowa data, without ethanol) versus set 2 plumes (Kansas data, with ethanol). The difference was significantly different for benzene ( $p < 0.001$ ), but not for toluene ( $p = 0.073$ ), as established by a Kruskal-Wallis test.

Table 2 summarizes the central tendencies of benzene and toluene plume lengths. The average length of BTEX plumes with ethanol was higher than the corresponding value without ethanol (by 36% or 70 feet for benzene, and by 17% or 26 feet for toluene). Similar to the Kruskal-Wallis test, two-sample student's t-tests showed that these differences were statistically significant for benzene ( $p = 0.002$ ) but not for toluene ( $p = 0.243$ ). Whereas an increase of 70 feet in the average length of benzene plumes is statistically significant, this does not imply that the corresponding increase in public health risk will also be significant.

Benzene plumes were generally longer than toluene plumes, and this difference was more pronounced for the data set with ethanol (set 2). Specifically, the average benzene plume was 20% longer than the average toluene plume for set 2, compared to a 4% difference for the data set without ethanol (set 1). A Wilcoxon signed rank test showed that both of these

Table 3 Predominant Lithologic Characteristics of the Sites Considered in This Study		
Material	Percent of Sites Where Material was Dominant	
	Set 1 (no ethanol)	Set 2 (with ethanol)
Clay	40	31
Limestone	4	0
Mixed	28	34
Sand	15	23
Shale	0	3
No data available	13	9

Table 4 Benzene Plume Length Statistics, Segregated by Dominant Type of Aquifer Material*			
Dominant Aquifer Material	Number of sites	Benzene Plume Length Average (ft)	Standard Deviation (ft)
<b>Set 1 (no ethanol, Iowa)</b>			
Clay	85	184	107
Limestone	8	155	105
Mixed	59	172	84
Sand	35	249	215
No data available	31	199	164
<b>Set 2 (with ethanol, Kansas)</b>			
Clay	8	242	89
Mixed	9	283	105
Sand	8	250	92
Shale	1	288	0
No data available	3	292	201

\*For a given set, differences between categories were not significantly different.

differences were statistically significant ( $p < 0.05$ ), which suggests that the potential elongating effect of ethanol could be more pronounced for benzene than for toluene (Figure 3). Benzene, which is the most toxic of the BTEX compounds, is relatively recalcitrant under the anaerobic conditions exacerbated by an ethanol-driven consumption of electron acceptors (Corseuil et al. 1998; Heider et al. 1998). Toluene is more frequently reported to degrade under anaerobic conditions. The methyl group in toluene is electrophilic and facilitates nucleophilic attack by water (Alvarez and Vogel 1995) or by anaerobic catabolic enzymes such as benzyl succinate synthase (Heider et al. 1998). This facilitates the initiation of degradation without the action of an oxygen requiring oxygenase enzyme. The higher biodegradability of toluene and its higher tendency than benzene to be retarded by sorption (Alvarez et al. 1998) are conducive to shorter plumes.

As is commonly the case for many epidemiological studies, it should be pointed out that the inferences of our statistical analysis are constrained by other factors besides the presence of ethanol that could influence plume length. Although Iowa and Kansas have a similar geologic history, unaccounted confounding factors include hydrogeologic and geochemical characteristics that control the rates of advection,

dilution, sorption, volatilization, and biodegradation, as well as site heterogeneity and the release and response scenarios. Unfortunately, logistical and cost constraints often preclude the quantification of these processes at gasoline-contaminated sites. Therefore, these factors could not be included in our statistical analysis, with the exception of considering borehole data that permitted the categorization of the sites according to the dominant type of aquifer material (Table 3). These data suggest that a slightly higher percentage of sites in set 1 were less permeable than in set 2 (i.e., 46% vs. 33% were clay-rich and 19% vs. 24% were sandy). Although plumes were generally longer in sandy than in clay-rich aquifers, the standard deviations for a given lithologic category were relatively large, as illustrated for benzene plumes (Table 4). Therefore, the dominant type of aquifer material did not have a statistically significant effect on plume length. This finding is consistent with previous plume studies (Rice et al. 1995; Mace et al. 1997). This does not mean that the type of aquifer material (and its associated permeability and sorption capacity) does not affect plume length. Rather, it implies that other factors that were not quantified could be more influential.

In spite of the many potentially confounding factors associated with field data, it should be recognized that (1) such confounding factors were likely randomized by the relatively large data set considered; (2) Kansas plumes were longer even though temperatures tend to be slightly warmer in Kansas than in Iowa, which is conducive to faster biodegradation; and (3) the results of the statistical analysis show a strong consistency of association with experimental and modeling results and with biologically plausible explanations discussed previously. Therefore, this work supports the hypothesis that the presence of ethanol in gasoline can lead to longer benzene plumes. These results should provide a basis for further field studies involving controlled gasohol releases to improve our gasohol-release risk assessment capabilities.

## Conclusion

This study investigated the potential magnitude and significance of BTEX plume elongation by the presence of ethanol in gasoline. There was a statistically significant difference in mean benzene plume lengths between gasoline- versus gasohol-contaminated sites. The mean toluene plume lengths were not significantly different. Ethanol apparently hinders the biodegradation of benzene to a greater extent than toluene because benzene is less degradable under strictly anaerobic conditions that are exacerbated by the depletion of electron acceptors during ethanol degradation. The significance of this effect, however, is probably site-specific, largely depending on the release scenario and the available electron acceptor pool.

## Acknowledgments

We thank Greg Hattan (KDHE) for providing the Kansas data, Jim Humeston (IDNR) for the Iowa data. Rich Keller, Jose Fernandez, Jason Assouline, Russ Sawvel, and Zeb Squires are gratefully acknowledged for their help in data processing, and Steve Hillis for valuable advice about the statistical analysis. This project was funded by the American

Petroleum Institute and by the U.S. Environmental Protection Agency.

## References

- Alvarez, P.J.J., and T.M. Vogel. 1995. Degradation of BTEX and their aerobic metabolites by indigenous microorganisms under nitrate-reducing conditions. *Water Science Technology* 31, 15–28.
- Alvarez, P.J.J., R.C. Heathcote, and S.E. Powers. 1998. Caution against interpreting gasoline release dates based on BTEX ratios in ground water. *Ground Water Monitoring & Remediation* 18, no. 4: 69–76.
- Corseuil, H.X., C.S. Hunt, R.C. Ferreira dos Santos, and P.J.J. Alvarez. 1998. The influence of the gasoline oxygenate ethanol on aerobic and anaerobic BTX degradation. *Water Resources Research* 33, no. 7: 2056–2072.
- da Silva, M.L.B., and P.J.J. Alvarez. 2002. Effects of ethanol versus MtBE on BTEX natural attenuation in aquifer columns. *Journal of Environmental Engineering* 128, no. 9: 862–867.
- Deeb, R.A., H.Y. Hu, J.R. Hanson, K.M. Scow, and L. Alvarez-Cohen. 2001. Substrate interactions in BTEX and MTBE mixtures by an MTBE-degrading isolate. *Environmental Science and Technology* 35, 312–317.
- Freedman, D., R. Pisani, and R. Purves. 1998. Tests of significance. In *Statistics*, 3rd ed. New York: WW Norton & Co. Inc.
- Groundwater Services Inc. 1997. Florida RBCA planing study. Prepared for Florida Partners in RBCA Implementation. Groundwater Services Inc., Houston, Texas. Available at [www.GSI-net.com](http://www.GSI-net.com).
- Heerman, S.E., and S.E. Powers. 1998. Modeling the partitioning of BTEX in water-reformulated gasoline systems containing ethanol. *Journal of Contaminant Hydrology* 34, no. 4: 315–341.
- Heermann, S.E., and S.E. Powers. 1996. The dissolution of BTEX compounds from oxygenated gasoline. In American Chemical Society Division of Environmental Chemistry preprints of extended abstracts, 212th. ACS 36, no. 1: 221–224.
- Heider, J., A.M. Spomann, H.R. Beller, and F. Widdel. 1998. Anaerobic bacterial metabolism of hydrocarbons. *FEMS Microbiological Review* 22, 459–473.
- Johnson, D.B., and T. Mizoguchi. 1978. Selecting the Kth Element in  $X + Y$  and  $X_1 + X_2 + \dots + X_m$ . *S.I.A.M. Journal Comp.* 7, 147–153.
- Lehmann, E.L. 1975. Nonparametrics. In *Statistical Methods Based on Ranks*, ed. Holden-Day.
- Mace, R.E., R.S. Fisher, D.M. Welch, and S.P. Parra. 1997. Extent, mass, and duration of hydrocarbon plumes from leaking petroleum storage tank sites in Texas. Bureau of Economic Geology. University of Texas at Austin. Geologic Circular 97-1.
- Malcom Pirnie Inc. 1998. Evaluation of the fate and transport of ethanol in the environment. Report prepared for the American Methanol Institute.
- McNab, W., S.E. Heermann, and B. Dooper. 1999. Screening model evaluation of the effects of ethanol on benzene plume lengths. Vol. 4, Ch. 4, LLNL Report UCRL-AR-135949-Report to the California Environmental Council in Response to Executive Order D-5-99.
- Molson, J.W., J. Barker, E.O. Frind, and M. Shirmir. 2002. Modeling the impact of ethanol on the persistence of benzene in gasoline-contaminated groundwater. *Water Resources Research* 38, no. 1: 4(1–12).
- Newell, C.J., L.P. Hopkins, and P.B. Bedient. 1990. A hydrogeologic database for groundwater modeling. *Ground Water* 28, no. 5: 703–714.
- Newell, C.J., and J.A. Connor. 1998. Characteristics of dissolved petroleum hydrocarbon plumes: Results from four studies. In *Proceedings of the 1998 Petroleum Hydrocarbons and Organic*

*Chemicals in Ground Water: Prevention, Detection and Remediation, Conference and Exposition*, Houston, Texas, 51–59. Westerville, Ohio: NGWA.

- Powers, S.E., D.W. Rice, B. Dooher, and P.J.J. Alvarez. 2001a. Replacing MTBE with ethanol as a gasoline oxygenate: How may groundwater resources be impacted? *Environmental Science and Technology* 35, no. 1: 24A–30A.
- Powers, S.E., C.S. Hunt, S.E. Heermann, H.X. Corseuil, D. Rice, and P.J.J. Alvarez. 2001b. The transport and fate of ethanol and BTEX in groundwater contaminated by gasoline. *Critical Reviews Environmental Science Technology* 31, no. 1: 79–123.
- Rao, P.S.C., L.S. Lee, and R. Pinal. 1990. Cosolvency and sorption of hydrophobic organic chemicals. *Environmental Science and Technology* 24, no. 5: 647–654.
- Rice, D.W., R.D. Grose, J.C. Michaelsen, B.P. Dooher, D.H. MacQueen, S.J. Cullen, W.E. Kastenber, L.G. Everett, and M.A. Marion. 1995. California leaking underground fuel tank (LUFT) historical case analysis. Environmental Protection Department. Nov. 16.
- Ruiz-Aguilar, G.M.L., J.M. Fernandez-Sanchez, R.S. Kane, D. Kim, and P.J.J. Alvarez. 2002. Effect of ethanol and MtBE on BTEX degradation: response variability for different aquifer materials under various electron-accepting conditions. *Environmental Toxicology Chemistry* 21, no. 12: 2631–2639.
- Saunderson, H.C. 1994. Multiquadratic surface, C. Computers. *Geosciences* 207, nos. 7-8: 103–1122.
- Tukey, J.W. 1977. *Exploratory Data Analysis*. Reading, Massachusetts: Addison Wesley.

## Biographical Sketches

*Graciela Ruiz-Aguilar is a post-doctoral fellow in the Department of Civil and Environmental Engineering at the University of Iowa, where she is conducting research on the anaerobic bioremediation of BTEX-ethanol mixtures. She has a Ph.D. in biotechnology and bioengineering from the Instituto Politecnico Nacional-CINVESTAV, in Mexico City, Mexico. Her studies focused on fungal technologies for PCB degradation*

*Kirk T. O'Reilly is a senior environmental specialist with ChevronTexaco's Energy Research and Technology Co. He has a B.S. in biological science from the University of California, Irvine, an M.S. in biology from Portland State University, and a Ph.D. in biochemistry from the University of Idaho. He has 16 years experience investigating the microbial and chemical aspects of the natural attenuation and active remediation of impacted ground water. Since 1996 his research has focused on oxygenate-related issues.*

*Pedro J. Alvarez is a professor in the Department of Civil and Environmental Engineering at the University of Iowa, where he also serves as associate director for the Center for Biocatalysis and Bioprocessing. He has a B. Eng. in civil engineering from McGill University, and an M.S. and a Ph.D. in environmental engineering from the University of Michigan. His research interests are related to the implications and applications of biological treatment processes to remove hazardous substances from contaminated ground water, waste water and soil. He is a P.E. and a Diplomate of the American Academy of Environmental Engineers.*

## Third International Conference on Pharmaceuticals and Endocrine Disrupting Chemicals in Water

Minneapolis, Minnesota • March 19–21, 2003

What is the scope of the threat to humans and wildlife from endocrine disrupting chemicals and prescribed pharmaceuticals? What are the maximum "safe" levels for these substances and how can we proactively prevent such substances, primarily developed to improve life, from causing harm? What new advances will change toxicology forever?

- Occurrence of Pharmaceuticals and Endocrine Disrupting Chemicals (EDCs) in Water
- Sources and Fate and Transport of EDCs
- Human Health Effects from Exposure to EDCs
- Antibiotics and Drug Resistant Bacteria
- Distribution and Effects on Wildlife
- Ground Water and Risk Management
- Proteomic and Genomic Approaches for Assessing EDCs' Effects on Cells
- Technologies for Detection, Evaluation of Metabolism, and Activities of EDCs
- Innovative and Cost-Effective Remediation and Treatment Technologies

### Co-sponsors:

U.S. EPA National Risk Management Research Laboratory  
U.S. Geological Survey Toxic Substances Hydrology Program  
Technical University of Berlin  
Brown Cancer Center, University of Louisville  
Minnesota Department of Health

National Ground Water Association  
601 Dempsey Road  
Westerville, OH 43081  
Phone: 800.551.7379  
Fax: 614.898.7786  
[www.ngwa.org](http://www.ngwa.org) and [wellowner.org](http://wellowner.org)

Plan now to attend this state-of-the-art conference! Log on to our Web site and go to "Events and Education" for the most current information on this and other conferences. You may register online at NGWA's Web site or call one of our Customer Service Representatives at 800.551.7379.

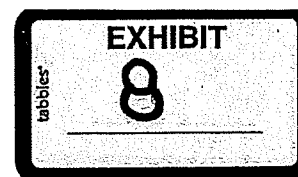

## Evaluation of the Impact of Fuel Hydrocarbons and Oxygenates on Groundwater Resources

TOM SHIH,<sup>\*,1,2</sup> YUE RONG,<sup>1</sup>  
THOMAS HARMON,<sup>5</sup> AND MEL SUFFET<sup>1</sup>

*Environmental Science and Engineering Program, University of California at Los Angeles, 46-081 CHS, Box 951771, Los Angeles, California 90095-1772, Department of Civil and Environmental Engineering, University of California at Los Angeles, 5732 C BH, Box 951593, Los Angeles, California 90095-1593, and California Environmental Protection Agency, Regional Water Quality Control Board, 320 4th Street, Suite 200, Los Angeles, California 90013*

The environmental behavior of fuel oxygenates (other than methyl *tert*-butyl ether [MTBE]) is poorly understood because few data have been systematically collected and analyzed. This study evaluated the potential for groundwater resource contamination by fuel hydrocarbons (FHCs) and oxygenates (e.g., *tert*-butyl alcohol [TBA], *tert*-amyl methyl ether [TAME], diisopropyl ether [DIPE], ethyl *tert*-butyl ether [ETBE], and MTBE) by examining their occurrence, distribution, and spatial extent in groundwater beneath leaking underground fuel tank (LUFT) facilities, focusing on data collected from over 7200 monitoring wells in 868 LUFT sites from the greater Los Angeles, CA, region. Excluding the composite measure total petroleum hydrocarbons as gasoline (TPH<sub>G</sub>), TBA has the greatest site maximum (geometric mean) groundwater concentration among the study analytes; therefore, its presence needs to be confirmed at LUFT sites so that specific cleanup strategies can be developed. The alternative ether oxygenates (DIPE, TAME, and ETBE) are less likely to be detected in groundwater beneath LUFT facilities in the area of California studied and when detected are present at lower dissolved concentrations than MTBE, benzene, or TBA. Groundwater plume length was used as an initial indicator of the threat of contamination to drinking water resources. Approximately 500 LUFT sites were randomly selected and analyzed. The results demonstrate MTBE to pose the greatest problem, followed by TBA and benzene. The alternative ether oxygenates were relatively localized and indicated lesser potential for groundwater resource contamination. However, all indications suggest the alternative ether oxygenates would pose groundwater contamination threats similar to MTBE if their scale of usage is expanded. Plume length data suggest that in the absence of a completely new design and construction of the underground storage tank (UST) system, an effective

management strategy may involve placing greater emphasis on UST program for ensuring adequate enforcement and compliance with existing UST regulations.

### 1. Introduction

The production and use of fuel oxygenates, particularly methyl *tert*-butyl ether (MTBE), have increased dramatically since the early 1990s as a consequence to federal and state regulations designed to improve air quality. The 1990 Federal Clean Air Act (CAA) Amendments mandated the use of winter oxyfuel or reformulated gasoline (RFG) to reduce carbon monoxide or ozone-forming hydrocarbon emissions in carbon monoxide and ozone nonattainment regions, respectively (1). In theory, the federal oxyfuel and RFG requirements do not specify a particular oxygenate, and gasoline refiners have several oxygenate options, including ethers (e.g., MTBE, diisopropyl ether [DIPE], ethyl *tert*-butyl ether [ETBE], *tert*-amyl methyl ether [TAME]) and alcohols (e.g., ethanol or *tert*-butyl alcohol [TBA]). In practice, however, MTBE has emerged as the dominant oxygenate in oxyfuel and RFG due to its lower cost and favorable transfer and blending characteristics (2). Currently, MTBE accounts for 85% of all oxygenates used in the United States or roughly 15 billion L year<sup>-1</sup> (3). While ethanol accounts for about 7% of the United States oxygenated fuel supply, ethanol is generally not used outside of the Midwest (4).

Fuel oxygenates can be accidentally introduced to subsurface environments during the refining, distribution, and storage of oxygenated fuels. Spills and leaks of oxygenate-containing gasoline pose a greater risk to groundwater resources as compared to that caused by other petroleum constituents (e.g., monoaromatics such as benzene, toluene, ethylbenzene, and total xylenes [BTEX]). Comparing to other petroleum constituents, fuel oxygenates are significantly more water soluble and are not adsorbed as readily to soil particles (see Table S1, Supporting Information), allowing them to travel farther and faster in groundwater (4–6). In addition, owing in part to their molecular structure, ether oxygenates including MTBE have been shown to resist biodegradation (7–11). The persistence and mobility of MTBE in subsurface environment, combined with its relative quantity in oxyfuel and RFG as compared to other gasoline constituents, have contributed to its dominant presence and frequent detection in groundwater plumes (4) and community water systems (CWS) (12). The relatively low odor threshold of MTBE renders many of these drinking water supplies with even low-level MTBE contamination to be unusable (13).

Concerns about potential groundwater contamination from MTBE have led several states to consider or enact MTBE bans (4). Unless the oxygenate requirements are removed through modification of the CAA, state- and federal-level bans of MTBE mean refiners must replace MTBE with another oxygenate. As a result, interest in the use and the environmental fate and transport of alternative oxygenates has increased significantly (14). However, to date, the state of knowledge is still quite limited for oxygenates DIPE, ETBE, TAME, and TBA (which together make up a total of up to 8% of United States oxygenates market). There are virtually no data on the environmental behavior of these other oxygenates (15), due primarily to difficulties in delineating their extent in the environment, lack of systematic analytical procedures for their determination as a group, and lack of regulatory requirement for their analysis. The extent and magnitude of

\* Corresponding author phone: (213) 576-6729; fax: (213) 576-6700; e-mail: Tshih@ucla.edu.

<sup>1</sup> Environmental Science and Engineering Program, University of California at Los Angeles.

<sup>2</sup> California Environmental Protection Agency.

<sup>5</sup> Department of Civil and Environmental Engineering, University of California at Los Angeles.

oxygenate contamination (other than MTBE) in the United States remains unknown. It is imperative that the environmental impacts of alternative oxygenates be properly assessed, since limited evidence available suggests they would pose groundwater contamination threats similar to MTBE (4), if used in similar percent by volume amounts.

This paper characterizes the potential for groundwater contamination of fuel hydrocarbons (FHCs) and oxygenates by examining their occurrence, distribution, and extent at leaking underground fuel tank (LUFT) sites. Specifically, data on the frequency of detection, maximum concentration, and contaminant plume length in groundwater of FHCs and oxygenates at LUFT sites in the greater Los Angeles region are presented. Contaminant plume length is the primary measure in this research because it reflects the potential of the contaminant to impact receptors. Secondary analysis of the correlation among FHC and oxygenate plume lengths and concentrations and time series analysis of contaminant plume length are also presented. In addition, this paper addresses the role of fuel oxygenates in influencing the behavior of FHC plumes at LUFT sites. Analysis of these data provides information on the current extent/magnitude of impact to groundwater resources caused by fuel releases, addresses the fate and transport of released gasoline constituents, and provides a basis for making preliminary predictions on the implications of the expected shift to alternative oxygenates as MTBE is phased out, or reduced, in gasoline.

The approach utilized is to treat LUFT sites as statistical populations (7). LUFT sites are particularly important because they represent major point sources of gasoline constituents and the leading cause of FHC and oxygenate groundwater contamination. According to U.S. Environmental Protection Agency's (USEPA) Safe Drinking Water Information System, some 385 000 known releases of gasoline have already occurred at LUFT sites nationally (5) and approximately 35% of the CWS wells have one or more LUFT sites within a 1-km radius of the well (5). This paper focuses California, specifically the Los Angeles region, as California's large consumption of fuel oxygenates makes the state an important environmental indicator for the national impacts of oxygenates. In fact, California's consumption of MTBE accounts for approximately one-fourth of global MTBE consumption (4) and some 6700 MTBE LUFT sites are located within 0.8-km radius of CWS wells in the state (16). Los Angeles, which comprises about 28% of the population in California (17), exemplifies a typical RFG-program participating metropolitan area.

## 2. Experimental Section

**2.1.1. Characterization of Contaminant Spatial Extent at LUFT Sites.** Groundwater plume length for a given contaminant is defined as the distance from the source area to the farthest edge of the plume at a predetermined concentration contour. In this paper, the dissolved plume length in groundwater for FHC (benzene), oxygenates (MTBE, DIPE, ETBE, TAME, and TBA), and total petroleum hydrocarbons as gasoline (TPH<sub>G</sub>) were investigated. TPH<sub>G</sub> is a useful indicator of the presence and magnitude of gasoline contamination and includes C<sub>4</sub>-C<sub>12</sub> compounds. Dissolved concentration contours were defined to 5 µg L<sup>-1</sup> for benzene and ether oxygenates to 10 µg L<sup>-1</sup> for TBA, and to 100 µg L<sup>-1</sup> for TPH<sub>G</sub>, taking into account both uniformity across different analytes as well as their method detection limits (MDLs). For each site, analytical data from groundwater monitoring wells, estimates of average groundwater gradient directions, and best professional judgment in extrapolating the most down-gradient well contaminant concentrations to the respective predetermined concentration contours were used to contour the groundwater plume for estimating spatial extent. Other

investigators (1, 16, 18) have applied similar methods for characterizing plume length.

Clearly, plume length as defined is two-dimensional. The lack of depth-specific data and other site-specific knowledge across the population of LUFT sites investigated in this paper preclude evaluation of plume transport in the vertical direction. In areas of significant recharge, this can bias the measurements toward shorter plumes, since a typical monitoring well screened across the water table may fail to detect the leading edge of the plume as it is deflected downward in response to the infiltration of recharge from above. Further, fluctuating flow directions as well as errors in their determination can result in monitoring well network configurations that create additional biases in plume length measurement. Despite these shortcomings, plume length remains an important indicator of the spatial extent of solute plumes and, in this paper, reflects the potential/relative potential of the FHCs and oxygenates to impact receptors.

**2.1.2. Site Selection and Sampling Protocol for Contaminant Plume Length Study.** From a list of over 1100 active LUFT facilities in the greater Los Angeles region, 500 facilities were randomly selected for site evaluation. Facilities qualified for inclusion in the plume length study if (a) sufficient groundwater monitoring data were available to define the contaminant plume lengths, (b) groundwater monitoring data covered at least the time period from 3rd quarter 2000 to 2nd quarter 2001, (c) at least one of the five fuel oxygenates of interest (MTBE, TBA, DIPE, ETBE, and TAME) was used or detected at the site, (d) at least one of the FHCs (TPH<sub>G</sub> and benzene) was used or detected at the site, and (e) site analytical data met California Regional Water Quality Control Board-Los Angeles Region's (CRWQCB-LA) laboratory quality assurance testing requirements (19).

To investigate the influence of oxygenates on FHC plume length at LUFT sites, a distinct "FHC-only" population of LUFT facilities was identified for comparison. From the same list of LUFT facilities referenced above, 700 facilities were randomly selected for site evaluation. The "FHC-only" population was selected based on identical facility inclusion criteria as above, with the exception that none of the five oxygenates of interest was used or detected at the site (as demonstrated by soil and groundwater historical data). For TPH<sub>G</sub> and benzene, only for 53 and 52 facilities, respectively, were plume lengths able to be estimated after examination of all 700 randomly selected sites.

**2.2. Occurrence and Distribution of FHCs and Oxygenates at LUFT Sites.** To investigate the occurrence/distribution of FHCs and oxygenates, data from LUFT sites were analyzed to determine the frequency of detection of FHCs and oxygenates at LUFT sites, their maximum site concentrations, and the correlation among these gasoline constituents. As part of the recent regulatory requirements adopted by the California State Water Resources Control Board, responsible parties for LUFT sites were required to submit laboratory analytical data and reports to the state Geotracker Internet Database in the Electronic Deliverable Format (EDF). From a list of over 1100 active LUFT facilities in the greater Los Angeles region, over 850 facilities had submitted their laboratory analytical data and reports in EDF, which ensured the data that were transmitted were of known quality and met all laboratory testing requirements specified by the regulatory agency (section 2.4). The resulting EDF from these facilities uniformly analyzed, at a minimum, FHC (BTEX), oxygenates (MTBE, DIPE, ETBE, TAME, and TBA) and TPH<sub>G</sub>. An extensive data analysis was conducted of the electronic data and hardcopy reports from these facilities. For the time period between January and March of 2002, a total of over 7200 monitoring wells were sampled for these facilities.

**2.3. Site Setting and Representativeness.** To determine whether the LUFT sites selected for this study were repre-

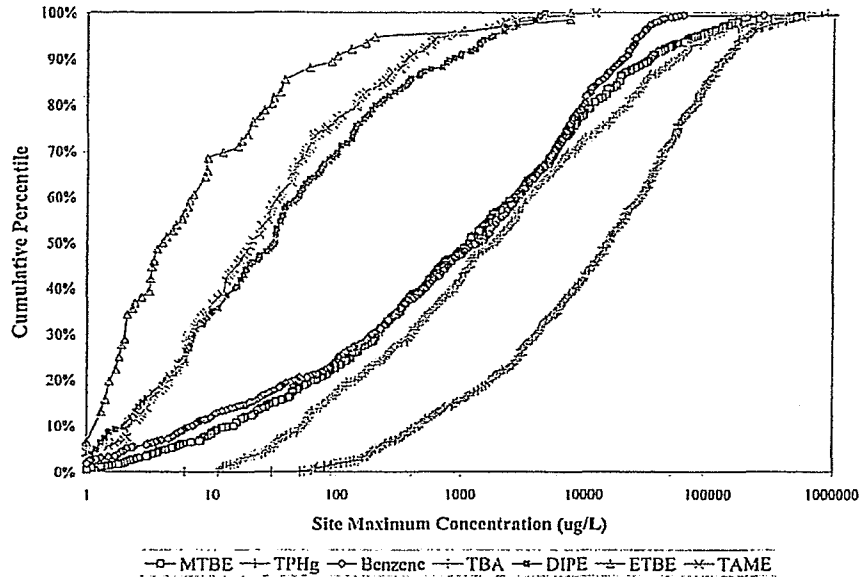

FIGURE 1. Plot of cumulative percentile of site maximum concentration for FHCs (TPH<sub>c</sub> and benzene) and oxygenates (MTBE, TBA, DIPE, ETBE, and TAME).

TABLE 1. Summary Statistics on LUFT Site Maximum Analyte Concentrations and Site Analyte Detection Frequencies<sup>a</sup>

	MTBE	TPH <sub>c</sub>	benzene	DIPE	ETBE	TAME	TBA
minimum ( $\mu\text{g L}^{-1}$ )	0.46	30	0.3	0.36	0.35	0.38	6
maximum ( $\mu\text{g L}^{-1}$ )	$1.6 \times 10^7$	$9.98 \times 10^8$	$4.2 \times 10^7$	4 700	7 500	12 000	$4.4 \times 10^6$
median ( $\mu\text{g L}^{-1}$ )	1 200	15 000	1 370	30	4	20	1 880
mean ( $\mu\text{g L}^{-1}$ )	44 840	3 783 500	83 750	290	260	240	30 120
<i>g</i> -mean ( $\mu\text{g L}^{-1}$ )	900	11 400	700	31	7	24	1 730
LUFT sites with detected analyte ( <i>n</i> )	718	797	716	206	77	159	530
analyte site detection frequency (%)	82.7	91.8	82.5	23.7	8.9	18.3	61.1

<sup>a</sup> Note: *g*-mean denotes geometric mean.

representative of the majority of LUFT sites in California, statistical analyses of site hydrogeology and contaminant impact were conducted in manner similar to Happel et al. (1) and reported in detail in text and figures in the Supporting Information.

**2.4. Analytical Methods.** The analysis of oxygenates as a group using conventional analytical procedures designed for petroleum hydrocarbons has been shown to be problematic (1, 20). USEPA Method 8020/21B, a protocol routinely employed for the analysis of LUFT samples, was unfit for monitoring of TBA and frequently yielded false-positive and inaccurate results when ether oxygenates were monitored in aqueous samples containing high TPH<sub>c</sub> concentrations (>1000  $\mu\text{g L}^{-1}$ ). In contrast, Halden et al. (20) demonstrated that USEPA Method 8260B (gas chromatography/mass spectrometry) was a robust protocol for oxygenates over a wide range of TPH<sub>c</sub> background concentrations. To ensure that appropriate protocols for the analysis of oxygenates were utilized, only those groundwater samples from LUFT sites that had been analyzed for BTEX and ether and alcohol oxygenates using USEPA Method 8260B were used for this study. TPH<sub>c</sub> was analyzed using USEPA Method 8015 nonaromatic, nonhalogenated chromatograph procedure. Laboratory MDLs for TPH<sub>c</sub>, BTEX, TBA, and ether oxygenates were set at 100, 1, 10, and 2  $\mu\text{g L}^{-1}$ , respectively.

### 3. Results and Discussions

**3.1. Occurrence and Distribution of FHCs and Oxygenates at LUFT Sites.** To determine the frequency of detection of FHCs and oxygenates at LUFT sites, their maximum site

concentrations, and the correlation among these gasoline constituents, groundwater monitoring data from over 7200 monitoring wells in EDF were analyzed from 868 LUFT sites in the greater Los Angeles region. At a reporting limit of 100, 1, 10, and 2  $\mu\text{g L}^{-1}$ , for TPH<sub>c</sub>, benzene, TBA, and ether oxygenates, respectively, 96% of the EDF-LUFT sites contained at least one FHC or oxygenate, 92% contained at least two analyzed compounds, 60% contained at least four compounds, and 1.5% contained all seven FHC and oxygenate compounds. TPH<sub>c</sub> was the analyte most frequently detected at 91.8% of EDF-LUFT study sites, followed by MTBE and benzene at 82.7% and 82.5%, TBA at 61.1%, and the alternative ether oxygenates DIPE, TAME, and ETBE at 23.7%, 18.3%, and 8.9%, respectively.

The site maximum analyte concentration (SMAC) was a good indicator of the source analyte concentration or strength in groundwater. SMAC was determined for each of the seven FHCs and oxygenates at individual EDF-LUFT study sites. Figure 1 depicts a comparison of the SMAC cumulative distributions. The results indicate that, excluding the composite measure TPH<sub>c</sub>, TBA has the greatest site maximum concentrations, followed by MTBE/benzene and DIPE, TAME, and ETBE. The mean, geometric mean, median, and other relevant measures are displayed in Table 1 for LUFT sites with detectable levels of analyte. The log-normality of the data sets, confirmed by graphical tools and more quantitative measures (e.g., coefficient of variation, the Shapiro-Wilk Test (21), and skewness), necessitated a natural log data transformation before computation of the *t*-test (21—

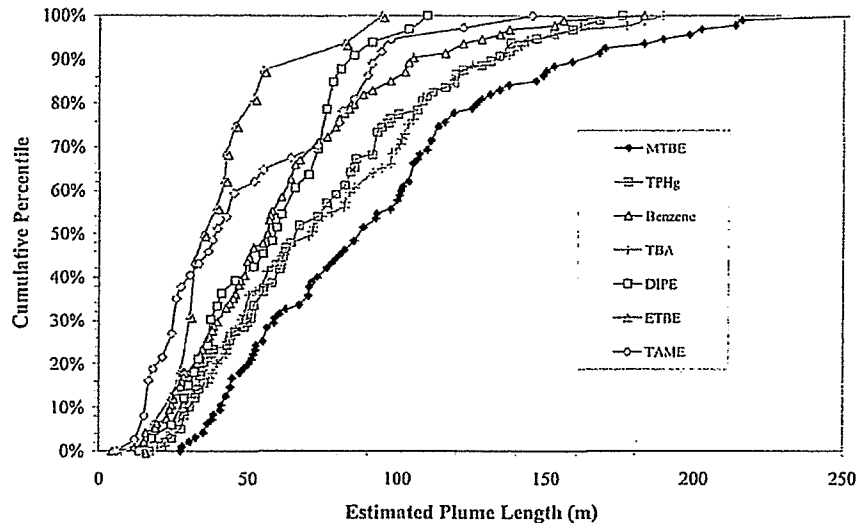

FIGURE 2. Plot of plume length cumulative percentile for FHCs (TPH<sub>C</sub> and benzene) and oxygenates (MTBE, TBA, DIPE, ETBE, and TAME). Note: benzene, ether oxygenate, TBA, and TPH<sub>C</sub> plume lengths were defined to 5, 5, 10, and 100 μg L<sup>-1</sup> dissolved concentration contours, respectively.

23) to examine the significance of variations in concentration observed among the FHC and oxygenate compounds. Bonferroni probability (*Bon. p*) was provided as protection for performing multiple *t*-tests simultaneously. Among the FHC and oxygenates, TPH<sub>C</sub> has the greatest geometric mean site maximum concentration, followed by TBA, MTBE, benzene, and the ether oxygenates DIPE, TAME, and ETBE (Table 1), confirming what is observed in Figure 1. The student *t*-test verified statistically significant ( $\alpha = 0.05$ , *Bon. p* < 0.05) differences for 20 out of 21 possible pairwise comparisons among the seven FHC and oxygenate compounds.

The study observations indicate low concentrations of alternative ether oxygenates (DIPE, ETBE, and TAME) at LUFT sites (e.g., 50% of the detected maximum site concentrations for ETBE, TAME, and DIPE were less than 5, 20, and 30 μg L<sup>-1</sup>, respectively (Figure 1)). Examinations of gasoline surveys provide definitive knowledge of which oxygenate and what volumes of that oxygenate are being used in a particular region of the country. As demonstrated by the 1995–1997 EPA Oxygenate Type Analysis and RFG Survey Data (24), the quantity of alternative ether oxygenates (DIPE, ETBE, and TAME) in Los Angeles area gasoline are near trace amounts (<<1% by weight), which may explain their low soluble source concentrations observed.

In addition, high TBA source concentrations were observed. In fact, excluding the composite measure TPH<sub>C</sub>, TBA has the greatest geometric mean site maximum groundwater concentration among our study analytes. This finding may be explained in terms of the solubility and sources of TBA. Even though TBA was added to gasoline in significantly lesser amounts than MTBE or benzene, its high miscibility meant that small quantities of TBA could translate into high groundwater concentrations. Further, different sources of TBA (as gasoline additive, impurity, or oxidation byproduct of MTBE) could by themselves, or in combination, result in the detected TBA in groundwater at LUFT sites.

**3.2. Characterization of Contaminant Spatial Extent at LUFT Sites.** Contaminant plume length was used as an initial indicator of the threat of contamination to drinking water sources by contaminants present in shallow groundwater at LUFT sites and was estimated according to procedures in section 2.1.1. Figure 2 presents FHC and oxygenate plume lengths in terms of cumulative percentile. The results indicate

that among the FHCs and oxygenates, MTBE has the greatest plume length, followed by TBA/TPH<sub>C</sub>, benzene, and the alternative oxygenates DIPE, TAME, and ETBE. The difference in plume length is clearly distinguishable, as in the case of MTBE versus FHC and MTBE versus other oxygenates. In contrast, pairwise comparisons between TBA/TPH<sub>C</sub>, benzene/DIPE, and TAME/ETBE cumulative distributions indicate that for these pairs, the variation in plume length is difficult to distinguish as demonstrated by the overlapping cumulative percentile curves.

The statistical significance of the plume length differences among the FHC and oxygenate groups was examined using the two sample *t*-test (after log-transformation). The log-normality of the data sets indicates that the geometric mean and the median are better descriptors of the LUFT plume population. Table 2 summarizes the data. Among the FHC and oxygenates, MTBE has the greatest geometric mean plume length at 83 m, followed by TPH<sub>C</sub>/TBA at 64 and 63 m, benzene/DIPE at 51 and 50 m, and TAME/ETBE at 36 and 34 m. The student *t*-test verified statistically significant ( $\alpha = 0.05$ , *Bon. p* < 0.05) differences for pairwise comparisons of MTBE and TBA to DIPE, ETBE, and TAME as well as comparisons between MTBE and TBA, MTBE and benzene, and TBA and benzene. In contrast, pairwise comparisons of DIPE, ETBE, and TAME to one another as well as benzene to DIPE or ETBE were not.

Contaminant groundwater plume length is influenced by factors such as hydrogeologic characteristics, matrix chemical interactions, source strength, biodegradation, and intrinsic properties of the chemical of interest. Under steady-state conditions, the differences in plume length among the FHCs and oxygenates at a particular site may be attributed primarily to differences in source strength and degradability of the contaminant. The lower source strengths of alternative ether oxygenates (DIPE, ETBE, and TAME) (Figure 1) as compared to MTBE, TBA, or FHCs may have contributed in large part to the observed localization of these plumes. In contrast, since the FHCs have source strengths of similar magnitudes as compared to MTBE and TBA (Figure 1), it is likely the significantly greater biodegradability of the FHCs (TPH<sub>C</sub> and benzene) relative to TBA and ether oxygenates favored the more restricted plume migrations from the source areas as compared to MTBE and TBA plumes.

TABLE 2. Summary Statistics on Estimated LUFT Site Analyte Plume Length in Groundwater<sup>a</sup>

	MTBE (5 µg L <sup>-1</sup> )	TPH <sub>C</sub> (100 µg L <sup>-1</sup> )	benzene (5 µg L <sup>-1</sup> )	DIPE (5 µg L <sup>-1</sup> )	ETBE (5 µg L <sup>-1</sup> )	TAME (5 µg L <sup>-1</sup> )	TBA (10 µg L <sup>-1</sup> )
facilities (n)	96	99	95	34	17	37	86
min (m)	26	11	7	14	15	6	15
max (m)	317	259	168	119	94	137	192
median (m)	84	66	51	58	35	40	61
mean (m)	96	75	60	55	39	47	73
<i>g</i> -mean (m)	83	64	51	50	34	36	63

<sup>a</sup> Note: *g*-mean denotes geometric mean.

TABLE 3. Change in Analyte Groundwater Plume Length over Time (1 year)<sup>a</sup>

	MTBE (5 µg L <sup>-1</sup> )	TPH <sub>C</sub> (100 µg L <sup>-1</sup> )	benzene (5 µg L <sup>-1</sup> )	DIPE (5 µg L <sup>-1</sup> )	ETBE (5 µg L <sup>-1</sup> )	TAME (5 µg L <sup>-1</sup> )	TBA (10 µg L <sup>-1</sup> )
case (n)	96	99	94	33	16	35	86
<i>g</i> -mean change (m)	-1.5	-0.3	0.6	0	1.5	1.2	3.7
<i>g</i> -mean (m)	83	64	51	50	34	36	63
% change	-1.8	-0.5	1.2	0	4.4	3.3	5.9
<i>P</i> value	0.28	0.89	0.61	0.94	0.58	0.19	0.06

<sup>a</sup> Note: negative *g*-mean change indicates that the plume length for the selected analyte decreased over time, while positive *g*-mean change indicates the opposite.

**3.3. Time Series Analysis of Contaminant Spatial Extent at LUFT Sites.** Contaminant plume lengths in groundwater were tracked for 1 year for a population of LUFT sites (section 2.1.2 for site selection). A total of 464 individual plumes were tracked resulting in a total of 1856 plume lengths estimated over four quarters (Figure S3, Supporting Information). Comparison of the cumulative percentile (CP) curves over four quarters indicate that for MTBE, TPH<sub>C</sub>, and benzene, the overlapping CP curves suggest the changes in plume length over this time period are not discernible—either the plume lengths are stable or the time period examined is not sufficient for changes to develop and/or be detected. In contrast, comparison of the CP curves for the alternative oxygenates ETBE, TAME, and TBA indicates a somewhat discernible trend of increasing plume lengths over the 1-year period. This trend is most apparent in the case of TBA, where the plume length increase over 1 year is ~6%. Decreases in contaminant plume length beneath LUFT study sites over time are likely to be the result of decreasing source strength from ongoing source removal and cleanup as well as biodegradation. Increases in contaminant plume length over time, on the other hand, may be due to a variety of factors. The more recent release of gasoline formulations containing significantly greater quantities of oxygenates may not have afforded sufficient time for oxygenate plumes to reach maximum plume configurations. As for TBA, since it is also a degradation product of MTBE, it is possible that as the MTBE plume farther away from the source area continues to degrade into TBA at concentrations above detection limit; these changes in TBA concentration would be detected by the peripheral monitoring network and thus result in increases in plume length contour.

To assess whether the plume length differences that develop over time were statistically significant, paired *t*-tests were performed (after log-transformation) for each FHC and oxygenate compound. The results indicate that after 1 year, none of the plume length differences that occurred during this period was significant at  $\alpha = 0.05$  (Table 3).

Rice et al. (25) conducted a trend analysis for benzene plume lengths with time and determined that approximately 60% of the sites studied contained no significant temporal trends, while 32% and 8% of the sites have decreasing and increasing temporal trends, respectively. While the vast majority of benzene and TPH<sub>C</sub> plumes are apparently stable

(1, 25), it remains to be seen whether oxygenate plumes have reached steady state. The different release histories of these compounds can be a factor in interpreting the plume length results. If the oxygenate plumes have not reached steady state, then the observed plume length results may not be indicative of future plume lengths. Time-series analysis of plume length data presented in this paper does lend some support to the stability of the plumes, FHC or oxygenate. However, substantially longer time-series analyses are needed to verify this assumption.

**3.4. Impact of Fuel Oxygenates on FHC Plume Lengths.** Several laboratory, modeling, and small-scale case studies have been conducted to investigate the impact of ethanol on FHC plumes (26–28). It has been demonstrated that high concentrations of ethanol have the potential to increase the spatial extent of FHC plumes primarily through (1) the reduction in the biotransformation rates of FHC attributed to a reduction of available electron-acceptor species that participate in biogeochemical oxidation/reduction reactions (27) and (2) increases in the solubility of FHCs through a cosolvency effect (28). To investigate whether the presence of fuel oxygenates other than ethanol can influence the mobility and spatial extents of FHC in a similar manner, two distinct populations of LUFT sites were identified. One population was composed of LUFT sites where oxygenates had been used or detected, versus another where none of the five oxygenates of interest had been used or detected (see section 2.1.2 for site selection/protocol). Figure 3 compares the FHC plume lengths at “FHCs only” versus at “FHCs and oxygenates” LUFT sites. A student *t*-test (after log-transformation) was used to test the significance of variations in TPH<sub>C</sub> and benzene plume lengths between the two populations of LUFT sites. The results indicate that TPH<sub>C</sub> and benzene plumes are significantly (at  $\alpha = 0.1$ ) longer (+20–30%) in the presence of oxygenates.

By comparing FHC (TPH<sub>C</sub> and benzene) plume lengths at LUFT sites that differ only in one respect (e.g., the presence or absence of oxygenates), an attempt was made to adjust for other differences between the population of LUFT sites. However, the presence or absence of oxygenates at LUFT sites may itself be indicative of the relative age of the spill. Not until the passage of 1990s CAA mandating the use of RFG or oxyfuel has the addition of oxygenate been so widespread and at such a dramatic scale. Consequently, LUFT



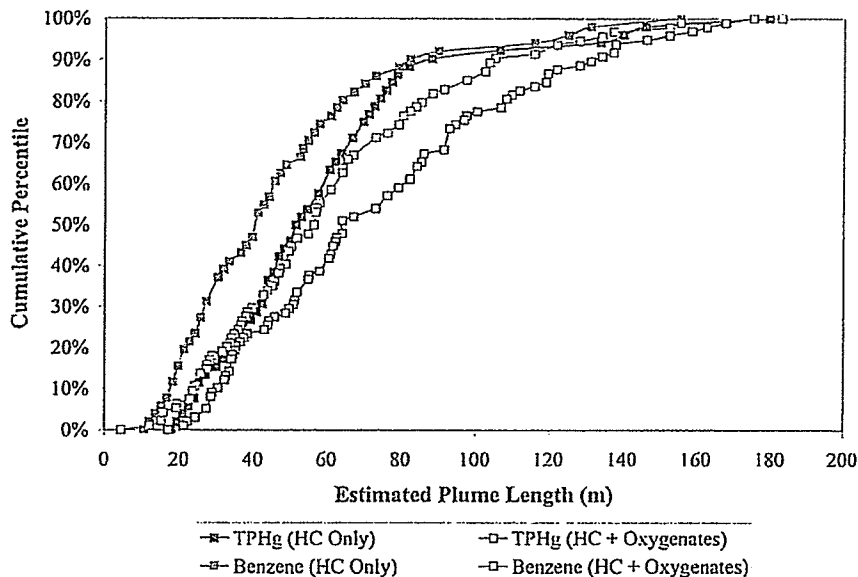

FIGURE 3. Comparison of TPH<sub>6</sub> and benzene plume lengths at "hydrocarbons only" versus at "hydrocarbons and oxygenates" LUFT sites. TPH<sub>6</sub> and benzene plume lengths were defined to 100 and 5  $\mu\text{g L}^{-1}$  dissolved concentration contours, respectively.

sites contaminated with both FHCs and oxygenates tend to have at least one or more recent fuel release(s). Conversely, LUFT sites impacted by only FHCs tend to have more aged source zones created by older spills from gasoline without oxygenate additives. Differences in the age of the spill can influence the length of FHC plumes since LUFT sites with more aged source zones also tend to have plumes that, relative to plumes at newer source zones, are stabilized or shrinking. Future work is needed to determine whether the increase in the FHC spatial extent is caused by the presence of oxygenates (e.g., through the mechanism of competition for electron acceptor species or the cosolvency effect) or is merely an artifact created by the inherent differences in the age of the spill resulting from the study design of separating LUFT sites into discrete populations ('FHCs-only' versus 'FHCs and oxygenates').

#### 4. Implications

The site detection frequencies and maximum groundwater concentrations for TBA, MTBE, and benzene were elevated. While the groundwater samples beneath LUFT sites across the states frequently are analyzed for a suite of FHC (e.g., BTEX) and some oxygenate (e.g., MTBE) compounds, the analysis for other oxygenates in most states has seldom been performed. Site groundwater concentrations and plume length data indicate TBA contamination at a scale similar to MTBE. In addition, due to its physical/chemical properties, TBA is often the regulatory driver for treatment considerations at LUFT sites. Therefore, the presence of TBA needs to be confirmed at gasoline-impacted sites, and if confirmed, a specific cleanup strategy needs to be developed that accounts for its presence along with any other FHC or oxygenate compounds that are present. In contrast to benzene, MTBE, and TBA, the site detection frequencies and maximum groundwater concentrations for alternative ether oxygenate DIPE, ETBE, and TAME beneath LUFT facilities were low. Plume length comparisons also indicate these alternative ether oxygenates to be localized relative to MTBE, TBA, or FHCs. Even though data from this study suggests that current risk from the alternative ether oxygenates to groundwater resources at LUFT sites should be minimal, caution should be applied against over-interpretation of the data in antici-

pating the consequences of possible scale-up in usage of these compounds. An appropriate parallel may be found in the progression of the MTBE problem. Prior to the 1990s, when MTBE was used primarily as an octane booster, it made up only 1–3% by volume of some gasoline. It was only after the scale of MTBE usage escalated in response to the 1990s CAA Amendments that the environmental consequences associated with its use became apparent. All indications (e.g., physical/chemical characteristics such as high solubilities and low biodegradabilities (relative to FHCs)) suggest that the alternative ethers would pose groundwater contamination threats similar to MTBE if their scales of usage were expanded.

With the staggering number of LUFT facilities located in close proximity to community drinking water sources, LUFT sites represent major point sources of gasoline constituents and the leading cause of FHC and oxygenate groundwater contamination. There is little doubt that a large proportion of underground storage tank (UST) systems at gasoline stations leak, and that is apparently true even for upgraded, double-tank systems. The number of leaks indicates that the problem is primarily in the design of the system, which arises from real estate limitations, fire defense considerations, and a defense against accidents and vandalism (29). In the absence of completely new design and construction of the system that emphasizes detection, repair, and containment, an effective management strategy may involve placing greater emphasis on a UST program for ensuring adequate enforcement and compliance with existing UST regulations. In California, existing UST regulations require, specifically, the upgrading of USTs and the institution of leak detection systems. The plume lengths data indicate that under a well-managed UST program, with prompt detection and cleanup of source contaminants associated with failed UST systems, FHC and oxygenate plume lengths in the hundreds of meters were quite rare. The overwhelming majority of plumes associated with release(s) from LUFT facilities were relatively "localized". For instance, an examination of plume lengths of alternative ether oxygenate DIPE, ETBE, and TAME found 90% of the plumes were less than 100 m from the source area. Even in the case of MTBE, 90% of the MTBE plumes were observed to be less than 165 m. The adequate compliance with existing UST regulations may decrease the prob-

ability of future leakage and allow for prompt response and cleanup of possible sources. This scenario could provide adequate safeguard against widespread and catastrophic impact of FHC and oxygenate plumes on groundwater sources since under these conditions the FHC and oxygenate plumes are likely to be localized.

#### Acknowledgments

Assistance for this project was provided by David Bacharowski, Joe Luera, Nhan Bao, and Sapna Hiranandani of CRWQCB-LA. The authors would also like to acknowledge the work previously conducted by Ann Happel, Brenden Dooher, and Dave Rice of Lawrence Livermore National Laboratory. This work followed some of their methods in delineating the environmental impacts from LUFT populations (1, 26).

#### Supporting Information Available

Analyses of site setting and representativeness and correlation among SMAC and among contaminant plume lengths are reported in detail in text, tables, and figures in the Supporting Information. This material is available free of charge via the Internet at <http://pubs.acs.org>.

#### Literature Cited

- (1) Happel, A. M.; Beckenbach, E. H.; Halden, R. U. *An Evaluation of MTBE Impacts to California Groundwater Resources*; 1998; UCRL-AR-130897.
- (2) Squillace, P. J.; Zogorski, J. S.; Wilber, W. G.; Price, C. V. *Environ. Sci. Technol.* 1996, 30, 1721–1730.
- (3) *The Report of the Blue Ribbon Panel on Oxygenates in Gasoline*; 1999; EPA 420-R-99-021.
- (4) Franklin, P. M.; Koshland, C. P.; Lucas, D.; Sawyer, R. F. *Environ. Sci. Technol.* 2000, 34(18), 3857–3863.
- (5) Johnson, R.; Pankow, J.; Bender, D.; Price, C.; Zogorski, J. *Environ. Sci. Technol.* 2002, 34(9), 210A.
- (6) Rong, Y. *Environ. Forensics* 2001, 2, 9–11.
- (7) Deeb, R. A.; Hu, H. Y.; Hanson, J. R.; Scow, K. M.; Cohen, L. A. *Environ. Sci. Technol.* 2001, 35, 312–317.
- (8) Mormile, M. R.; Liu, S.; Sulflita, J. M. *Environ. Sci. Technol.* 1994, 28, 1727–1732.
- (9) Yeh, C. K.; Novak, J. T. *Water Environ. Res.* 1994, 66, 744–756.
- (10) Squillace, P. J.; Pankow, J. F.; Korte, N. E.; Zogorski, J. S. *Environ. Toxicol. Chem.* 1997, 16, 1836–1844.
- (11) Fayolle, F.; Vandecasteele, J. P.; Monot, F. *Appl. Microbiol. Biotechnol.* 2001, 56, 339–349.
- (12) Squillace, P. J.; Moran, M. J.; Lapham, W. W.; Price, C. V.; Clawges, R. M.; Zogorski, J. S. *Environ. Sci. Technol.* 1999, 33(23), 4176–4187.
- (13) Stocking, A.; Suffet, I. H.; McGuire, M. J.; Kavanaugh, M. *AWWA* 2001, 93(3), 95–105.
- (14) Deeb, R. A.; McMillan, B.; Kavanaugh, M. C. *Environmental Fate and Transport of Fuel Oxygenates*; Proceedings of Petroleum Hydrocarbons and Organic Chemicals in Groundwater, 2001, Houston, Texas.
- (15) Ellis, P. *A Circle Vicious: what do we know about the other oxygenates?* New England Interstate Water Pollution Control Commission, L.U.S.T.LINE, Bulletin 37, March 2001.
- (16) Happel, A.; Dooher, B.; Beckenbach, E. *MTBE Impacts to California Groundwater*; USEPA Blue Ribbon Panel, March 25, 1999, UCRL-MI-133696.
- (17) Williams, P. R. D.; Sheehan, P. J. *AEHS Contaminated Soil Sediment & Water*; spring 2001, pp 23–28.
- (18) Dooher, B. P. *Screening Analysis of Potential Groundwater Resource Impacts from Gasoline Containing Ethanol or MTBE*; 1999, UCRL-AR-135949.
- (19) California Regional Water Quality Control Board—Los Angeles. *General Laboratory Testing Requirements for Petroleum Hydrocarbon Impacted sites*; June 5, 2000.
- (20) Halden, R. U.; Happel, A. M.; Schoen, S. R. *Environ. Sci. Technol.* 2001, 35(7), 1469–1474.
- (21) Bohrnstedt, G. W.; Knoke, D. *Statistics for Social Data Analysis*; F. E. Peacock Publishers, Inc.: Itasca, IL, 1988.
- (22) Rong, Y. *Environ. Geosci.* 1997, 4(3), 149–152.
- (23) Rong, Y. *Environ. Forensics* 2000, 1, 213–220.
- (24) USEPA 1995 and 1996 Oxygenate Type Analysis RFG Survey Data. <http://www.epa.gov/otaq/consumer/fuels/mtbe/oxy-95-00.pdf>
- (25) Rice, D. W.; Grose, R. D.; Michaelson, J. C.; Dooher, B. P.; MacQueen, D. H.; Cullen, S. J.; Kastenburger, W. E.; Everett, L. E.; Marino, M. A. *California Leaking Underground Fuel Tank Historical Case Analyses*; 1995; UCRL-AR-122207.
- (26) Rice, D.; Powers, S. E.; Alvarez, P. J. *Potential Scenarios for Ethanol-containing Gasoline released into Surface and Sub-surface Waters*; 1999; UCRL-AR-135949.
- (27) Alvarez, P. J.; Hunt, C. S. *The effect of ethanol on BTEX biodegradation and natural attenuation*; 1999; UCRL-AR-135949.
- (28) McNab, W.; Heermann, S. E.; Dooher, B. *Screening Model Evaluation of the Effects of Ethanol on Benzene Plume Lengths*; 1999; UCRL-AR-135949.
- (29) Green, J. *Soil, Sediment & Groundwater*; MTBE special issue, March 2000.

Received for review May 9, 2003. Revised manuscript received September 5, 2003. Accepted October 1, 2003.

ES0304650

## United States Department of State 12.1

---

**Reference:** Keystone XL Project  
Risk Analysis

**Request:**

DOS recently received a copy of a report that questions the validity of the risk analysis for the proposed Keystone XL Project that is summarized in the Section 3.13 of the supplemental draft EIS and included, in part, in Appendix P to the draft EIS. The undated report, *Analysis of Frequency, Magnitude and Consequence of Worst-Case Spills From the Proposed Keystone XL Pipeline*, was prepared by John Stansbury, Ph.D., P.E. DOS requests that Keystone provide a response to that report, indicating whether or not the author has accurately portrayed the Keystone risk analysis, whether or not the author has made valid assumptions regarding the analysis of risk included in the report, and any other responses that would assist DOS in comparing the information in the report to the risk analysis submitted by Keystone. Please include in your response any clarification to the existing risk assessment that may be required to adequately address valid concerns (if any) raised in the Stansbury report.

**Response Part A:**

An initial response to the Stansbury Report was previously provided to DOS. That response is repeated below. It is supplemented with the information in Response Part B.

The Stansbury/Friends of the Earth Report (Stansbury Report) attempts to build on a foundation of inaccurate assumptions that lead to greatly exaggerated estimates of releases of oil and consequences. This is simply the latest case of opportunistic fear-mongering, dressed up as an academic study.

The Keystone Pipeline system is subject to comprehensive pipeline safety regulation under the jurisdiction of the U.S. Department of Transportation, Pipeline and Hazardous Materials Safety Administration (PHMSA). As the recent State Department Supplemental Draft Environmental Impact Statement (SDEIS) recognizes, PHMSA is responsible for protecting the American public and the environment by ensuring the safe and secure movement of hazardous materials to industry and consumers by all transportation modes, including pipelines. To protect the public and environmental resources, Keystone is required to construct, operate, maintain, inspect, and monitor the pipeline in compliance with the PHMSA regulations at 49 CFR Part 195, as well as relevant industry standards and codes. These regulations specify pipeline material and qualification standards, minimum design requirements, required measures to protect the pipeline from internal, external corrosion, and many other aspects of safe operation.

Above and beyond the PHMSA regulations, Keystone has agreed to comply with 57 additional Special Conditions developed by PHMSA for the Keystone XL Project. Keystone has agreed to

Prepared By: Meera Kothari, Jesse Bajnok & Heidi Tillquist

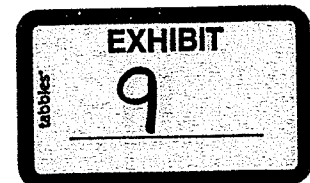

incorporate these conditions into its design and construction, and its manual for operations, maintenance, and emergencies required by 49 CFR 195.402. These 57 Special Conditions are attached as Appendix C to the SDEIS.

PHMSA and the State Department took these 57 Special Conditions into account in the SDEIS. It is significant to note the finding in the SDEIS with respect to these conditions:

Incorporation of those conditions would result in a Project that would have a degree of safety over any other typically constructed domestic oil pipeline system under current code and a degree of safety along the entire length of the pipeline system similar to that which is required in High Consequence Areas (HCAs) as defined in 49 CFR 195.450. (SDEIS p. 2-9)

Based on an initial review, below are some of the major mistakes and misrepresentations in the Stansbury Report.

**1. Stansbury Report Mistake: “River crossings are especially vulnerable,” going on to describe “the pipeline is more susceptible to corrosion because it is below ground and pressures are relatively high.”**

**The Facts: Keystone XL Pipeline is not vulnerable at river crossings; document referenced in report does not suggest it is.**

Background: The Summary report states (p. 2) that that “River crossings are especially vulnerable,” going on to describe that here “the pipeline is more susceptible to corrosion because it is below ground and pressures are relatively high.”

In the corresponding section of Professor Stansbury’s full report, headed “Most Likely Spill Locations” (p. 6), the author states that adjacent to rivers, “the pipeline is susceptible to high rates of corrosion because it is below ground (DNV, 2006).” (Note that there is no reference in this section of the report to the additional claim in the Summary that at river crossings “pressures are relatively high.”)

Nowhere in the 2006 DNV document cited is there any suggestion that buried pipe at river crossings is more vulnerable to corrosion than any other portion of the buried pipeline. Nor is there any support for the statement in the summary about relative operating pressure at river crossings increasing susceptibility to corrosion.

The only statement in the DNV report remotely related to this unfounded assertion is this: “The Keystone Pipeline is being designed to consist entirely of below ground pipe except within Pump Station fence lines. Sections of the pipeline below ground were considered to be more likely to incur corrosion than above ground sections.”

Further, the statement in the DNV report was made within a section that highlights special measures Keystone will employ to eliminate risk of external corrosion. Keystone employs an approach to corrosion protection that has virtually eliminated failure due to external corrosion in the 30-plus years it has been in use. It includes fusion bond epoxy coating (FBE) coupled with active cathodic protection, which places a small current on the pipe preventing loss of metal due to corrosion. Keystone also will be inspected more frequently than standard regulations require, to ensure the effectiveness of this system.

Prepared By: Meera Kothari, Jesse Bajnok & Heidi Tillquist

Relative to other failure modes at river crossings, such as flooding or increased river flows scouring the river bottom or banks and exposing the pipe and making it vulnerable to damage or breakage, Keystone will utilize the horizontal directional drill (HDD) crossing method that places the pipe 25 feet or more below the river bottom at locations where scour is considered a potential threat. Other measures at river crossings further reduce the likelihood of failure. For instance, each of the river crossings mentioned in the report (Yellowstone, Missouri, Platte) will be installed using the HDD method and will utilize heavy-walled pipe with sacrificial abrasion-resistant coating applied over the FBE to further ensure the protective capability of the coating. These measures make these locations among the **least likely for a release** on the entire pipeline.

**2. Stansbury Report Mistake: The report incorrectly asserts that TransCanada ignored 23% of statistical pipeline failures (pp. 1, 4).**

**The Facts: TransCanada’s analysis accurately represents historical data and does not overlook 23% of incidents as claimed**

Background: The report incorrectly asserts that TransCanada ignored 23% of statistical pipeline failures (pp. 1, 4). In part because the PHMSA data does not identify the cause for 23% of pipeline incidents, TransCanada used a more detailed assessment of causes of historical pipeline incidents, evaluating Keystone against each of these threats to establish an accurate risk profile. The applicable threats to the pipeline were determined using established pipeline industry standards ASME B31.8S and API 1160. This fact was noted within the DNV report itself:

“It should be noted that the factors are similar but not identical to the U.S. Department of Transportation Office of Pipeline Safety (OPS) categories of failure (e.g., third party harm).” (DNV 2006, p. 3)

**3. Stansbury Report Mistake: TransCanada “arbitrarily assigned a drain-down factor” for the pipeline**

**The Facts: TransCanada estimates of volume released – arbitrarily adjusted in the Stansbury Report – use results of a detailed study prepared by the California Fire Marshal**

In calculating how much oil might be released from a pipeline after it is secured and isolated, the author claims TransCanada “arbitrarily assigned a drain-down factor” for the pipeline (p. 9). Not noted, however, is that TransCanada’s methodology reflects not TransCanada’s judgment but rather the results of an independent assessment by the California Fire Marshal in its role as a regulator in California. The report is well known and respected among pipeline regulators and risk assessors. After labeling use of the California Fire Marshal figure for retained volume “arbitrary,” it is ironic that the author goes on to say the factor “is likely too high” and cuts it in half with no further justification.

**4. Stansbury Report Mistake: TransCanada’s adjustment to risk factors are arbitrary and improper**

**The Facts: TransCanada adjustments to risk factors are consistent with industry experience**

Prepared By: Meera Kothari, Jesse Bajnok & Heidi Tillquist

Background: The Summary report states that “TransCanada arbitrarily and improperly adjusted spill factors” (p. 1). The full report written by Professor Stansbury is less strident, suggesting the adjustments are “probably not appropriate” (p. 4).

The majority of pipeline infrastructure in North America was constructed many decades ago at a time when the materials, coating systems, and ongoing inspection capabilities that will be used for Keystone XL were not available. Studies show the benefits of these technologies in reducing pipeline incidents. For instance (as described in para. #1 above), the corrosion protection Keystone uses has virtually eliminated external corrosion as a cause of failure. Approximately two thirds of the pipelines in the US were constructed prior to 1970. It is therefore entirely appropriate to use an incident frequency for Keystone XL that is derived from pipelines of its class. To do otherwise would be like trying to estimate the gas mileage of a 2011 model car by using the average gas mileage of all cars built since the 1920s.

This is corroborated by observations included in the SDEIS, including:

“It is likely that both incident frequency analyses tend to overestimate the likely spill frequency of the proposed Project since both analyses rely on data that include incidents on older pipelines that would not be operated under the Project-specific Special Conditions developed by PHMSA and incorporated into the design, construction, operations, and maintenance plans for the proposed Project.” (SDEIS, p. 3-98)

Examples of measures taken by TransCanada to reduce risk on Keystone include:

- External corrosion – Keystone employs an approach to corrosion protection that has virtually eliminated failure due to external corrosion in the 30-plus years it has been in use. It includes fusion bond epoxy coating and active cathodic protection, which places a small current on the pipe preventing loss of metal due to corrosion. Keystone has agreed to a special regulatory condition requiring the pipeline to be internally inspected with an instrumented device that monitors the pipe wall for anomalies. Any wall degradation due to corrosion would be detected and addressed prior to failure. (These requirements are covered by several PHMSA Special Conditions, including #9, 10, 11, 33, 35-39, 42, 53.)
- External impact – Keystone will be buried at a deeper depth to minimize risk of external impact. In addition, pipe walls will exhibit greater puncture resistance and fracture control properties. Keystone will take additional steps to minimize risk of accidental excavation damage. (Required by PHMSA Special Conditions #7, 19, 40, 41, 48, 53, 54).
- Internal corrosion – Limit sediment and water content of oil shipped to 0.5%. Run cleaning tools twice per year in the first year and as necessary based on integrity analysis. Implement a crude oil monitoring and sampling program to ensure products transported meet specifications. Perform internal inspections at increased frequency. (Required by PHMSA Special Conditions #33, 34, 42, 53)
- Mechanical defect – enhanced material requirements and QA/QC program as described in PHMSA Special Conditions #1, 2, 4, 5, 6, 8, 12, 22.

**5. Stansbury Report Mistake: The report erroneously relies on disproven assumptions on corrosivity of oil to be shipped.**

Prepared By: Meera Kothari, Jesse Bajnok & Heidi Tillquist

**The Facts: Independent analysis of oil sands derived crude oils has conclusively demonstrated that, below 450 degrees Fahrenheit, these oils are not corrosive to steel.**

Background: The Stansbury Report states Keystone is subject to higher failure rates due to corrosivity of oil to be shipped (p. 5). Independent analysis of oil sands derived crude oils has conclusively demonstrated that, below 450 degrees Fahrenheit, these oils are not corrosive to steel. The maximum operating temperature anywhere in the pipeline is 150 degrees. (Supplemental Draft EIS, Keystone XL, p. 3-112.) A recent independent assessment of crude oil quality by the firm Crude Quality Inc., including corrosion potential, has been completed and provided to the U.S. Department of State supporting these findings.

Keystone XL will ship a wide variety of crude oil types including conventional oil, shale oil, partially upgraded synthetic oil and oil sands derived bitumen blends. None of these crude types create a risk of destroying the pipeline from within and causing leaks. Furthermore these products have shipped and are currently being shipped across to the US via other cross-border pipelines from Canada. It would be an uneconomic business proposition to spend \$13 billion dollars constructing a pipeline system that would be destroyed by the product it transported.

#### **6. Stansbury Report Mistake: The erroneously states that abrasive sediment in the crude oil will cause higher failure rates**

**The Facts: The oil that will be shipped on Keystone XL “shall have no physical or chemical characteristics” that would damage or harm the pipeline.**

Background: Report states Keystone is subject to higher failure rates due to abrasive sediment (p. 5). However, as clarified in the SDEIS, oil transported by Keystone must meet strict limits for sediment and water. (SDEIS, p. 3-116)

Special Condition 34 (see Appendix C of this SDEIS) addresses the sediment and water content of the crude oil that would be transported by the proposed Project and states the following:

“Internal Corrosion: Keystone shall limit basic sediment and water (BS&W) to 0.5% by volume and report BS&W testing results to PHMSA in the annual report.”

The FERC-approved tariff for transport of oil on the Keystone Pipeline system also requires that all oil to be shipped:

“shall have no physical or chemical characteristics that may render such Petroleum not readily transportable by Carrier or that may materially affect the quality of other Petroleum transported by Carrier or that may otherwise cause disadvantage or harm to Carrier or the Pipeline System, or otherwise impair Carrier’s ability to provide service on the Pipeline System.” (SDEIS, Pp. 3-116.)

#### **7. Stansbury Report Mistake: The report erroneously states bitumen will sink, therefore “posing significant threat” to water resources.**

**The Facts: The gravity of crude oils that Keystone XL would transport are less than the specific gravity of water.**

Prepared By: Meera Kothari, Jesse Bajnok & Heidi Tillquist

Background: The report states bitumen will sink “posing significant threat” (p. 19). This issue was addressed in the SDEIS, which includes the following summary statement: “the specific gravity of the crude oils that would be transported on the proposed pipeline ranges from about 0.85 to about 0.93, less than the specific gravity of water. These crude oils, therefore, tend to float on water...” (SDEIS, p. 3-104)

**8. Stansbury Report Mistake: The report suggests that TransCanada will cut back on monitoring and maintenance activities, causing increased risk in out years (p. 5).**

**The Facts: Contrary to a suggestion in the Stansbury Report, monitoring and maintenance activities are a required condition of operation.**

Background: The report suggests that TransCanada will cut back on monitoring and maintenance activities, causing increased risk in out years (p. 5). However, the U.S. Code of Federal Regulations requires many of these monitoring and maintenance activities as a condition of operation. TransCanada has voluntarily committed to 57 additional safety conditions that include other enhanced monitoring and maintenance activities as additional conditions of continued operation. For instance, in order to continue to operate the pipeline, TransCanada must perform in-line inspection with a smart pig, conduct corrosion surveys, and perform valve inspections at specified frequencies – these are not discretionary. Additionally, TransCanada must meet requirements to patrol the pipeline every two weeks.

In addition to regulatory requirements, continuing to invest in the safety of the pipeline makes sense from a business perspective. Paying for increased maintenance is built into TransCanada’s contracts with its shippers such that variable integrity spending costs are flowed through to the shippers. Additionally, the FERC rate allows the uncommitted toll to rise at a greater than inflation rate which allows for recovery of maintenance costs. There is therefore no financial incentive for TransCanada to cut back on monitoring and maintenance and a substantial financial penalty associated with leaks in the form of fines, cleanup costs, lawsuits and reputational damage. It is therefore not reasonable to suggest that TransCanada or another owner would increase their liability in order to reduce an expense that is flowed through to the customers.

**9. Stansbury Report Mistake: The report tries to suggest that because shutdown on another pipeline took longer, that increased time should be the new assumption on shutdown time (pp. 7-8).**

**The Facts: Keystone time to shutdown has been accurately reflected in the risk analysis and is consistent with Keystone’s record.**

Background: The Stansbury Report tries to suggest that because shutdown on another pipeline took longer, that increased time should be the new assumption on shutdown time (pp. 7-8). However, the author does not address the differences in system design and operating characteristics (including single phase flow in Keystone) that make it unlikely that Keystone operators would experience difficulty detecting a leak. Nor does he address industry information sharing nor the workings of the regulatory regime, both of which serve to make it unlikely that operational errors are repeated.

Prepared By: Meera Kothari, Jesse Bajnok & Heidi Tillquist



Additionally, Keystone has established its own operating record that demonstrates prompt reaction time to any indication of an operational abnormality. These response records align with the shut down times conveyed in Keystone's risk assessment report.

**10. Stansbury Report Mistake: Report suggests that enough oil to fill a dozen Olympic-sized swimming pools would go unnoticed in Nebraska (pp. 8-9).**

**The Facts: The report's calculation of spill volume for "small" leak not credible because it ignores leak detection methodologies designed to detect low rate or seepage releases.**

Background: In assessing worst-case "small" leak, the Stansbury Report suggests that enough oil to fill a dozen Olympic-sized swimming pools would go unnoticed in Nebraska (pp. 8-9). The estimate ignores leak detection methodologies designed to detect low rate or seepage releases.

As described below, Keystone will utilize a state-of-the-art integrated leak detection system. Real-time computerized systems can detect spills as low as 1.5 percent of throughput. In addition to surveillance and public reporting, Keystone will implement a non-real time mass balance procedure that can detect spills below 1.5 percent of throughput.

Data from actual pipeline spills demonstrate that substantial leaks do not go undetected for long periods of time. Further, those spills that are not detected within the first 48 hours are typically relatively small. PHMSA records (2001 through 2009) indicate that the majority of spills are 3 barrels or less, regardless of detection time. These data also indicate that the majority of spills are detected within 2 hours, with 99 percent of spills detected within 7 days. Of those spills not detected within the first 48 hours, the majority of spills were 15 barrels or less. In summary, large spills do not remain undetected for substantial periods of time.

The pipeline will be monitored 24 hours a day, 365 days a year from the Operations Control Center (OCC) using a sophisticated Supervisory Control and Data Acquisition (SCADA) system. Keystone will utilize multiple leak detection methods and systems that are overlapping in nature and progress through a series of leak detection thresholds. The leak detection methods are as follows:

- Remote monitoring performed by the OCC Operator 24/7, which consists of monitoring pressure and flow data received from pump stations and valve sites fed back to the OCC by the Keystone SCADA system. Remote monitoring is typically able to detect leaks down to approximately 25 to 30 percent of the pipeline flow rate.
- Software-based volume balance systems that monitor receipt and delivery volumes. These systems are typically able to detect leaks down to approximately 5 percent of the pipeline flow rate.
- Computational Pipeline Monitoring or model-based leak detection systems that break the pipeline into smaller segments and monitor each of these segments on a mass balance basis. These systems are typically capable of detecting leaks down to a level of approximately 1.5 to 2 percent of pipeline flow rate.
- Computer-based, non-real time accumulated gain/(loss) volume trending to assist in identifying low rate or seepage releases below the 1.5 to 2 percent by volume detection thresholds.

Prepared By: Meera Kothari, Jesse Bajnok & Heidi Tillquist

- Direct observation methods, which include aerial patrols, ground patrols, and public and landowner awareness programs that are designed to encourage and facilitate the reporting of suspected leaks and events that may suggest a threat to the integrity of the pipeline.

The leak detection system will be configured in a manner capable of sending an alarm to the OCC operators through the SCADA system and also will provide the OCC operators with a comprehensive assortment of display screens for incident analysis and investigation. In addition, there will be a redundant, stand-by OCC to be used in case of emergency.

Keystone also will have an Emergency Response Program (ERP) in place to respond to incidents. The ERP contains comprehensive manuals, detailed training plans, equipment requirements, resources plans, auditing, change management and continuous improvement processes. The Integrity Management Program (IMP) (49 CFR Part 195) and ERP will ensure Keystone will operate the pipeline in an environmentally responsible manner.

**11. Stansbury Report Mistake: The report relies on old claims that the emergency response plan for the Keystone pipeline is “woefully inadequate”**

**The Facts: Contrary to assumptions in the Stansbury Report, the Emergency Response capability for Keystone XL will meet or exceed requirements.**

Background: The Stansbury Report relies on old claims that the emergency response plan for the Keystone pipeline is “woefully inadequate” (p. 3). This accusation was one of the items reviewed in detail in the SDEIS.

“DOS and PHMSA have reviewed these hypothetical spill response scenarios prepared by Keystone and would also review a final ERP to be prepared by Keystone prior to startup of the proposed pipeline...Based on its review of the hypothetical spill response scenarios, *DOS considers Keystone’s response planning appropriate and consistent with accepted industry practice.*” (SDEIS, p. 3-122)

**12. Stansbury Report Mistake: The report includes exaggerated descriptions of the physical extent of benzene.**

**The Facts: The exaggerated claims in the report do not match any oil-spill experience; furthermore, benzene concentration in heavy oils Keystone will ship will be comparable to other heavy oils shipped in the U.S. and will generally be lower than benzene concentrations in lighter crudes and in refined products such as gasoline.**

Background: Benzene concentration in heavy oils Keystone will ship will be comparable to other heavy oils shipped in the U.S. and will generally be lower than benzene concentrations in lighter crudes and in refined products such as gasoline.

Exaggerated descriptions of the physical extent of benzene in the Stansbury Report do not match any oil-spill experience. The report does not account for emergency response containment and cleanup. Examination of field data collected from large spills into rivers typically finds that concentrations of petroleum products become undetectable in a relatively short distance. For example, following a 10,000 barrel release in 2007 from the Coffeerville Refinery in Kansas into

the Verdigris River, the EPA found no detectable concentrations of petroleum products 20 miles downstream at the closest municipal water intake.

**13. Stansbury Report Mistake: The report claims TransCanada cut risk factors in half.**

**The Facts: TransCanada reflected the results of industry studies regarding failure rates of pipe-related equipment, reducing by half the anticipated number of failures caused by material defect.**

Background: TransCanada assumed that its pipeline would be constructed so well that it would have only half as many spills as the other pipelines in service. Not true. Rather, TransCanada reflected the results of industry studies regarding failure rates of pipe-related equipment, reducing by half the anticipated number of failures caused by material defect. As discussed in item #4 above, measures that help achieve this performance are among the Special Conditions to which TransCanada has committed.

Here is the statement from the TransCanada report: “A 50% reduction in the DOT leak frequency was applied to the entire pipeline because the U.S. portion of Keystone will consist of entirely new materials and be constructed to meet current standards and requirements.” [DNV section 4.1.13, page 13] The statement occurs in a section of the DNV report describing risk of mechanical defect. Other risk factors are adjusted differently for above-ground and below-ground pipe for instance.

**14. Stansbury Report Mistake: The report suggests that releases at pump station sites means Keystone is using less reliable pipe.**

**The Facts: None of the pump stations releases involved pipeline.**

Background: As of June 1, 2011 the Keystone pipeline has experienced fourteen (14) unplanned releases within pump/valve station facility sites, averaging 5-10 barrels each. None of these incidents have involved the pipeline itself. In two cases, nearby adjacent property was affected by spray. Otherwise, the incidents were contained within our pump station facility. Equipment has been replaced or repaired. In all cases, Keystone’s operation personnel immediately isolate all releases and clean up and remediation efforts are employed to mitigate any effects to the environment.

TransCanada meets or exceeds all notification and reporting requirements to all state and federal agencies. In many of these cases, reporting to regulatory agencies was not required due to the very small volume of these spills. TransCanada has taken a transparent approach to proactively report all spills to federal and state regulatory agencies regardless of volume. Pipelines are the safest method of transporting the oil that must be moved throughout North America everyday.

## **Response Part B:**

Mr. Stansbury's document referenced above (the "Stansbury document") does not accurately portray the Keystone XL risk analysis nor has the author made valid assumptions regarding the analysis of the risk included in the report. The discussion below responds to a number of the points in the Stansbury document.

- 1. The expected frequency of spills from the Keystone XL pipeline reported by TransCanada (DNV, 2006) was evaluated. (Stansbury document at p. 1)**

The DNV 2006 report is irrelevant to Keystone XL Pipeline Project. The Keystone XL pipeline project risk assessment is based on the Keystone XL Pipeline Project Risk and Consequence Analysis, April 2009 and Appendix A, Analysis of Incident Frequencies and Spill Volumes For Environmental Consequence Estimation for the Keystone XL Project, July 2009.

- 2. The worst-case spill volume at the Hardisty Pumping Station was understated. (Stansbury document at pp. 1-2).**

The Hardisty Pump Station in Alberta Canada is irrelevant to the risk assessment for the US segments of the Keystone XL pipeline Project. Moreover, Stansbury's worst case spill estimates are based on incorrect assumptions, as discussed below.

- 3. The primary difference between Stansbury's worst-case spill estimate and TransCanada's estimate is that TransCanada used 19 minutes as the expected time to shut down pumps and close valves (TransCanada states that it expects the time to be 11.5 minutes for the Keystone XL pipeline). Since a very similar pipeline recently experienced a spill (the Enbridge spill), and the time to finally shut down the pipeline was approximately 12 hours, and during those 12 hours the pipeline pumps were operated for at least 2 hours, the assumption of 19 minutes or 11.5 minutes is not appropriate for the shut-down time for the worst-case spill analysis. Therefore, worst-case spill volumes are likely to be significantly larger than those estimated by TransCanada. (Stansbury document at p. 2).**

Keystone has calculated the worst case discharge for the Keystone XL pipeline in accordance with 49 CFR §194.105. The Stansbury document suggests that, because shutdown on another pipeline took longer, that increased time should be used as the shut down time assumption for the Keystone XL Pipeline. Enbridge's pipeline was constructed in 1969, while Keystone XL Pipeline would be constructed in 2013 and would meet or exceed current regulatory standards. Stansbury does not take into account that the Keystone XL pipeline is instrumented at every mainline valve and has new, state-of-the-art leak detection and operator training systems that make it unlikely that Keystone operators would experience difficulty detecting a leak. Nor does he address industry information sharing or the workings of the regulatory regime, both of which serve to make it unlikely that alleged operational errors on one system are repeated on another system.

In addition, Stansbury does not take into account the fact that worst case discharge is determined using a large leak that would be instantaneously detected by the leak detection system resulting

Prepared By: Meera Kothari, Jesse Bajnok & Heidi Tillquist

in immediate initiation of shut down procedures. Nonetheless, in determining its worst case discharge, Keystone conservatively assumed a 10 minute leak confirmation period, plus nine minutes for pump shut down, plus a 3 minute valve closure time, for a total of 22 minutes. While detection of a smaller leak may require additional confirmation time, the small volumes released would not approach worst case discharge amounts. For example, Keystone has experienced small leaks at pumping stations on the Keystone system which resulted in releases that were a fraction of the estimated worst case discharge volumes. Despite being small, these leaks were identified by the sophisticated leak detection system employed on the pipeline and appropriate shut down and isolation measures were initiated. It is incorrect to assume that there could be a small leak that remained undetected for an extended period of time, as suggested by the Stansbury document (see item 15).

- 4. The worst-case spill volumes from the Keystone XL pipeline for the Missouri, Yellowstone, and Platte River crossings were estimated by Stansbury to be 122,867 Bbl, 165,416 Bbl, and 140,950 Bbl, respectively. In addition, this analysis estimated the worst-case spill for a subsurface release to groundwater in the Sandhills region of Nebraska to be 189,000 Bbl (7.9 million gallons). (Stansbury document at p. 2)**

The results of the risk assessment for the Keystone XL pipeline are conservative as the largest spill on record from PHMSA records January 1986-May 2011 for large diameter hazardous liquid pipelines is 40,500 bbl of which 39,800 bbl was recovered. This occurred in 1991 on a 1967 vintage pipeline. Spills greater than 10,000 barrels are uncommon, occurring in less than 0.5 percent of all pipeline spills. Moreover, these estimates are based on incorrect assumptions regarding shut down times as outlined in response #3.

- 5. The benzene released by the worst-case spill to groundwater in the Sandhills region of Nebraska would be sufficient to contaminate 4.9 billion gallons of water at concentrations exceeding the safe drinking water levels. This water could form a plume 40 feet thick by 500 feet wide by 15 miles long. (Stansbury document at p. 2).**

This claim is unsupported and disproven by field studies throughout the US. The groundwater study (Newell and Connor 1998) summarized the results of four nationwide studies looking at groundwater plumes from petroleum hydrocarbon contamination. The results show that movement of petroleum hydrocarbons is very limited, moving 312 feet or less in 90 percent of the cases. The longest plume was approximately 3,000 feet in length. Therefore, if groundwater became contaminated, any plume would be expected to result in highly localized effects. Importantly, these limits tend to be independent of the rate of groundwater flow. In contrast, chemicals used in some industries and in agriculture, such as commercial solvents, such as PCE and TCE (tetrachloroethylene and trichloroethylene) and pesticides, have much greater mobility and environmental persistence when compared to oil and its constituents.

- 6. Among numerous toxic chemicals that would be released in a spill, the benzene (a human carcinogen) released from the worst-case spill into a major river (e.g., Missouri River) could contaminate enough water to form a plume that could extend more than 450 miles. (Stansbury document at p. 2).**

Prepared By: Meera Kothari, Jesse Bajnok & Heidi Tillquist

This claim is unsubstantiated and unsupported by actual field data nor does it account for containment and cleanup efforts by the operator that limit downstream movement. For example, reference is made to a 2007 spill in Coffeerville, Kansas that released 10,000 barrels of crude oil that entered the flooded Verdigris River. EPA samples reported concentration of petroleum hydrocarbons to be below threshold limits at the first sampling point, located 12 downstream miles of the spill. In 2010, an Enbridge 30-inch pipeline ruptured, spilling 19,500 barrels of oil into the Kalamazoo River system. EPA reports that contamination has been documented in localized areas within 30 miles of the spill's origin. These case studies demonstrate that actual contamination is much less than implied by the Stansbury document.

**7. In estimating spill frequency, TransCanada ignored historical data for spills from "other causes," which represents 23 percent of historical pipeline spills (Stansbury document at pp. 1, 4).**

In its failure frequency analysis, Keystone determined the threats that are actually applicable to the Keystone XL Pipeline by using the combination of variables in the Time Dependant, Stable and Time Independent categories listed in API 1160<sup>1</sup> Section 8.7 and ASME B31.8S<sup>2</sup>. Keystone then used the PHMSA data for the categories of incidents that are associated with these applicable threats. The data for "other causes" was not used because it consists of offshore pipeline, offshore platform, tankage, tankage piping and terminal incidents data that are not applicable to the Keystone XL Pipeline. Keystone did however consider spills at pumping and metering facilities in its analysis of the PHMSA data.

**8. In estimating spill frequency, TransCanada assumed that its pipeline would be constructed so well that it would have only half as many spills as the other pipelines in service. The modification of historical pipeline incident data to account for modern pipeline materials and methods is "probably" overstated for this pipeline. (Stansbury document at pp. 1, 46)**

The modification for modern materials and methods is fully appropriate. Based on the PHMSA incident database January 1, 1986 through May 31, 2011, there are two (2) reported pipeline incidents on crude oil pipelines manufactured with high strength steel (grade X70 or higher) due to pipeline material and methods. This first incident was due to external corrosion and occurred in 1998 on a 1985 vintage pipeline. The second pipeline incident occurred on small diameter (24inch or less). This incident was due to electric flash resistance (ERW) pipe seam failure and occurred in 2007 on a 1998 vintage pipeline. As Keystone is a large diameter pipeline, its method of joining is double submerged arc welding (DSAW) and not ERW. Furthermore,

---

<sup>1</sup> Section 8.7. In any risk assessment method, the likelihood is estimated using a combination of variables in categories such as the following: external corrosion, internal corrosion, third party damage, ground movement, design and materials, system operations

<sup>2</sup> ASME B31.8 S "Managing System Integrity of Gas Pipelines" classifies threats to pipelines in terms of "Time Dependant", "Stable" and "Time Independent" categories. Time Dependant Threats include: External Corrosion; Internal Corrosion; and, Stress Corrosion Cracking (SCC); Stable Threats include: Manufacturing Defects; Welding / Fabrication Related; and, Equipment Failure; and, Time Independent Threats include: Third Party / Mechanical Damage; Incorrect Operations, and Weather and Outside Force (Geotechnical)

Keystone will protect the pipeline from external corrosion using fusion bond epoxy (FBE) and a cathodic protection (CP) system. The combination of FBE and CP has proven effective over TransCanada's 30+ years of operation. Keystone implements 24 hour surveillance during pipe manufacturing and coating. Lastly, Keystone has implemented nine (9) specific material related conditions and will implement thirteen (13) construction method related conditions set forth in the PHMSA Special Condition Appendix C, over and above current regulations, which would ensure that Keystone is the safest pipeline built in North America, thereby minimizing any potential for spills resulting from materials and construction methods.

In order to establish the particular incident threats that would apply to the Keystone XL pipeline during its operational life, three key points were considered:

- Keystone XL is a new construction project, developed with the benefit of TransCanada's more than 50 years of pipeline construction and operating experience;
- The pipeline will be constructed and operated in accordance with comprehensive regulatory guidelines (49 CFR Part 195) and pipeline design standards (ASME B31.4), and;
- At the time the risk assessment was prepared, Keystone had applied to PHMSA for a Special Permit to allow it to design, construct and operate the pipeline up to 80% of the steel pipeline's specified minimum yield strength (SMYS). The Special Permit application provided that Keystone would comply with a number of pipeline integrity conditions over and above the applicable PHMSA regulations and industry standards. This included the 51 conditions from the Special Permit 2006-26617 issued by PHMSA to TransCanada for the Keystone Pipeline Project in April 2007. Keystone included these conditions in the base design of the Keystone XL Project and recognized their impact in modifying historic failure frequency data in preparing the Risk Assessment. Subsequent to the completion and submittal of the Keystone XL Project Pipeline Risk Assessment and Environmental Consequence Analysis in April 2009, Keystone withdrew the Special Permit Application. Nonetheless, PHMSA ultimately developed and recommend that Keystone adopt 57 conditions over and above the applicable regulations and industry standards and in some cases exceeding the requirements of the 51 conditions listed in the Keystone Special Permit 2006-26617. Keystone agreed to adopt these conditions, which are set forth in Appendix C of the Supplemental Draft EIS. Accordingly, the design assumptions underlying the failure frequency modifications remain conservative.

Taking these factors into consideration, the applicable threats were determined using both the American Society of Mechanical Engineers (ASME) B31.8S Managing System Integrity of Gas Pipelines and American Petroleum Institute (API) 1160 Managing System Integrity of Hazardous Liquid Pipelines as guidance. These standards outline processes for pipeline operators which can be used to assess risks and make decisions about risks in operating pipelines in order to reduce both the number of incidents and the adverse effects of errors and incidents. Moreover, in view of Keystone's adoption of additional conditions beyond those taken into account during preparation of the Risk Assessment, the modifications to historic failure frequency data reflected in the 2009 Risk Assessment are actually even more conservative.

9. Keystone will operate the pipeline at higher temperatures and pressures and the crude oil that will be transported through the Keystone XL pipeline will be more corrosive than the conventional crude oil transported in existing pipelines, which tends to increase failure frequency. The diluted bitumen to be transported through the Keystone XL Pipeline will be significantly more corrosive and abrasive than conventional crude oil. (Stansbury document at pp.1, 4-5).

Keystone has withdrawn its application to operate up to 80% SMYS thereby reducing its throughput and operating pressure. PHMSA Special Condition 15 provides that “under no circumstances may the pump station discharge temperatures exceed 150° Fahrenheit (°F) without sufficient justification that Keystone’s long-term operating tests show that the pipe coating will withstand the higher operating temperature for long term operations, and approval from the appropriate PHMSA region(s).”

The potential for internal corrosion (IC) to develop during transportation of oil sands derived crude oils due to sediment and solids is considered low. The following factors support the conclusion that the risk of corrosion from sediments and solids is low:

- Keystone’s tariff specifications group sediments/solids with water content. The tariff contains a restriction of 0.5% solids and water by volume.
- “Solids and water” is comprised mostly of water, with solids typically at 5% of the solids/water content (reference [www.crudemonitor.ca](http://www.crudemonitor.ca))
- Keystone will utilize a number of operating measures that will minimize solids in the pipeline:
  - periodic cleaning
  - turbulent flow operating regime
  - sediments are benign at the pipeline’s proposed operating temperature (not to exceed 150°F per PHMSA Special Condition 15)

PHMSA Special Condition 34 requires Keystone to limit basic sediment and water (BS&W) to 0.5% by volume and report BS&W testing results to PHMSA annually. Keystone must run cleaning pigs twice in the first year and as necessary in succeeding years based on the analysis of oil constituents, liquid test results, and weight loss coupons in corrosion threat areas. At a minimum, in years after the first year, Keystone must run cleaning pigs once per year, at intervals not to exceed 15 months. Liquids collected during the pig runs, including BS&W, must be sampled, collected, and analyzed and internal corrosion plans must be developed, based on lab test results. This mitigation plan will be incorporated in the Keystone XL Integrity Management Plan and must be reviewed at least quarterly based upon crude oil quality. Keystone will also monitor and implement adjustments for the presence of deleterious crude oil stream constituents as per the PHMSA Special Conditions.

Furthermore, an independent analysis performed by Crude Quality Inc of oil sands derived crude oils has conclusively demonstrated that, below 450 degrees Fahrenheit, the oil sand crude oils are not corrosive to steel.<sup>3</sup>

In addition, the Energy Resources Conservation Board of Alberta issued a statement on February

---

<sup>3</sup> CAPP Response to US DOS re Keystone XL



16, 2011 stating “the ERCB can identify only three spills resulting from internal corrosion between 1990 and 2005 (and only eight from 1975 to 2010) [for Alberta pipelines]. The resulting average failure frequency for the grouping of crude oil pipelines from 1990 to 2005 is thus 0.03 per 1000 km per year. This is significantly lower than the U.S. rate quoted in [a recent Natural Resources Defense Council] study of 0.08 per 1000 km per year.”<sup>4</sup> The ERCB stated further that:

Analysis of pipeline failure statistics in Alberta has not identified any significant differences in failure frequency between pipelines handling conventional crude versus pipelines carrying crude bitumen, crude oil or synthetic crude oil. Diluent by nature is a lower viscosity, higher-vapour pressure solvent. It could then be considered to be more “volatile” in its natural state, as it consists of lighter end hydrocarbons. However, when blended with bitumen, the resulting blend is a “new” product consisting of thinned bitumen that more closely resembles conventional crude products. Once mixed with diluent, DilBit should behave in much the same manner as other crude oils of similar characteristics. In conventional oils sands processing, sulphur is removed during processing, as well as water (which is a primary concern in regards to corrosivity). The tariff specification for the Keystone XL project, for example, is virtually the same in regards to water content and solids contents as that specified for other heavy oil pipelines, thus there is no reason to expect this product to behave in any substantially different way than other oil pipelines. It should also be noted that pipelines in Alberta have never been safer. In 2009, Alberta posted a record-low pipeline failure rate of 1.7 pipeline failures per 1,000 km of pipeline (considering all substances), bettering the previous record-low of 2.1 set in both 2008 and 2007.”<sup>5</sup>

- 10. Although pipeline technology has improved, new pipelines are subject to proportionately higher stress as companies use this improved technology to maximize pumping rates through increases in operational temperatures and pressures, rather than to increase safety margins. (Stansbury document at p.5)**

Keystone XL pipeline is design in accordance with 49 CFR §195.106 and ASME B31.4. The federal regulation limits the pipeline’s operating stress to no more than 72% of the pipeline steel material’s specified minimum yield strength. Operating temperature is addressed in Item 9 above.

- 11. TransCanada relies on “soft” technological improvements which require an on-going commitment to monitoring and maintenance resources and which should not be assumed to be constant over the projected service life of the pipeline, and are**

---

<sup>4</sup> ERCB ADDRESSES STATEMENTS IN NATURAL RESOURCES DEFENSE COUNCIL PIPELINE SAFETY REPORT February 16, 2011

<sup>5</sup> ERCB ADDRESSES STATEMENTS IN NATURAL RESOURCES DEFENSE COUNCIL PIPELINE SAFETY REPORT February 16, 2011

subject to an ongoing risk of error in judgment during operations. (Stansbury document at p.5).

The PHMSA regulations at 49 CFR Part 195 require many of these monitoring and maintenance activities as a condition of operation. Keystone has voluntarily committed to 57 additional safety conditions that include other enhanced monitoring and maintenance activities as additional conditions of continued operation. For instance, in order to continue to operate the pipeline, Keystone must perform in-line inspections, conduct corrosion and depth of cover surveys, and perform valve inspections at specified frequencies – these are not discretionary. Additionally, Keystone must patrol the pipeline 26 times per year, at intervals not to exceed three weeks.

In addition to regulatory requirements, continuing to invest in the safety of the pipeline makes sense from a business perspective. Paying for increased maintenance is built into Keystone's contracts with its shippers such that variable integrity spending costs are flowed through to the shippers. Additionally, the FERC rate allows the uncommitted toll to rise at a greater than inflation rate which allows for recovery of maintenance costs. There is therefore no financial incentive for Keystone to cut back on monitoring and maintenance and a substantial financial penalty associated with leaks in the form of fines, cleanup costs, lawsuits and reputational damage. It is therefore not reasonable to suggest that Keystone or another owner would increase their liability in order to reduce an expense that is flowed through to the shippers.

**12. The TransCanada spill frequency estimation consistently stated the frequency of spills in terms of spills per year per mile. This is a misleading way to state the risk or frequency of pipeline spills. Spill frequency estimates averaged per mile can be useful; e.g., for extrapolating frequency data across varying pipeline lengths. However, stating the spill frequency averaged per mile obfuscates the proper value to consider; i.e., the frequency of a spill somewhere along the length of the pipeline. (Stansbury document at p. 5).**

Keystone was transparent in its use of statistics, including where and how they were derived, how they were applied, and by expressing the potential risk in a variety of ways to promote greater understanding and clarity to a broad audience. Spill frequencies are expressed several ways throughout the document to facilitate comparison with other pipelines and modes of transport, and to promote project-specific understanding. As suggested, spill frequencies expressed as an average per mile facilitates comparison with pipelines of various lengths and to national averages, which are also expressed in this normalized expression of risk. Within the same sentence of expressing the average risk value in terms of incidents/per mile\*year (page 3-2), risk was immediately expressed in terms of risk for the whole pipeline over a 10-year period and as an occurrence interval for any single mile of pipe. This provides decision-makers multiple opportunities to understand spill risk and how it applies to the project as a whole as well as to an individual's piece of property. The risk assessment addresses risk specifically to the project as a whole and by pipeline segment (Table 3-1), providing an estimate of the number of spills that could occur over a ten-year period. The risk assessment also uses the spill frequency and historical spill volume data to estimate the potential frequency of different sizes of spills (Table 3-2). In Section 4 of the risk assessment, these same statistics are used to generate estimates of spill frequency and spill volumes in high consequence areas.

Prepared By: Meera Kothari, Jesse Bajnok & Heidi Tillquist

- 13. Likely failure points include welds, valve connections, and pumping stations. A vulnerable location of special interest along the pipeline system is near the side of a major stream where the pipeline is underground but at a relatively shallow depth. (Stansbury document at p. 6)**

Keystone is required to conduct non-destructive examination of 100% of the pipeline and pump station welds, in addition to a hydrostatic pressure test. (PHMSA Special Conditions 5, 8, 20, 22). Furthermore, below-ground mainline valve connections are welded, hydrostatically tested and capable of inspection by an in-line inspection tool. Pump station infrastructure undergoes regular maintenance and inspection, piping and equipment is contained within property boundaries which are contained by berms.

The Keystone XL pipeline is designed with a minimum depth of cover of 5 feet below the bottom of waterbodies including rivers, creeks, streams, ditches and drains for a depth normally maintained over a distance of 15 feet on each side of the waterbody measured from the top of the defined stream channel. The depth of cover may be modified by Keystone based on site specific conditions and in accordance with PHMSA Special Condition 19. The Project's depth of cover meets or exceeds the federal requirements noted in 49 CFR 195.248 of 48 inches for inland bodies of water with a width of at least 100 feet from high water mark to high water mark (for normal excavation, 18 inches for rock excavation) and PHMSA Special Condition 19 on depth of cover. Furthermore, major rivers will be crossed employing the horizontal directional drill (HDD) method, whereby the pipe is installed at a minimum of 25 feet below the river bottom there by eliminating the potential for scour to affect the pipeline's integrity. HDD crossings also utilize pipe with a wall thickness of 0.748 inch and abrasion resistant coating applied over top of the FBE coating.

- 14. An independent assessment of TransCanada's emergency response plans for the previously built Keystone pipeline was done by Plains Justice (Blackburn, 2010). This document clearly shows that the emergency response plan for the Keystone pipeline is woefully inadequate. Considering that the proposed Keystone XL pipeline will cross much more remote areas (e.g., central Montana, Sandhills region of Nebraska) than was crossed by the Keystone pipeline, there is little reason to believe that the emergency response plan for Keystone XL will be adequate. (Stansbury document at p. 3).**

Keystone is required to submit its emergency response plan for the Keystone XL Pipeline to PHMSA prior to commencing operations for review and approval. As contrasted with Mr. Blackburn, a lawyer, PHMSA has the professional and technical expertise necessary to perform an independent and competent evaluation of the adequacy of the emergency response plan. Significantly, as part of the State Department's review of the project, Keystone was required to present its approach to oil spill response under specific hypothetical spill scenarios to DOS and PHMSA. Based on review of Keystone's response to those scenarios, the SDEIS found that Keystone's spill response planning "is appropriate and consistent with accepted industry practice" (SDEIS p. 3-122). Moreover, PHMSA has already approved the emergency response plan for the Keystone Pipeline, which will serve as the model for the Keystone XL plan.

- 15. Slow leaks could go undetected for long periods of time (e.g., up to 90 days). (Stansbury document at p.7).**

While it is theoretically possible for a very small leak to go undetected for 90 days, data from actual pipeline spills demonstrate that substantial leaks do not go undetected for long periods of time. Further, those spills that are not detected within the first 48 hours are typically relatively small. PHMSA records (2001 through 2009) indicate that the majority of spills are detected within 2 hours, with 99 percent of spills detected within 7 days. Additionally given that leak occurrence is effectively random in time, if a patrol interval is fixed and equal to 14 days, then the time between leak occurrence and leak detection by patrol will range between zero days and 14 days, and it can be shown through modelling that the average time between occurrence and detection will be equal to one-half of the patrol interval (i.e., 7 days). Furthermore, in the context of a risk assessment, where the consequences are weighted by probability of occurrence, the average time is the most appropriate value.

- 16. Stansbury assumes a shut-down time of 2 hours for the worst case spill for a large leak (Stansbury document at p. 8).**

See response to Item number 3.

- 17. Given the difficulty for operators to distinguish between an actual leak and other pressure fluctuations, the shut-down time for the worst case volume calculation should not be considered to be less than 30 minutes for a leak greater than 50 percent of the pumping rate. This would allow for 4 alarms (5 minutes apart) to be evaluated by operators and a 5<sup>th</sup> alarm to cause the decision to shut down. In addition, the time to shut down the systems (pumps and valves) would require another 5 minutes. The assumption that the decision to shut the pipeline down can be made after a single alarm, as is suggested by TransCanada (ERP, 2009) is unreasonable considering the difficulty in distinguishing between a leak and a pressure anomaly. (Stansbury report at p. 8).**

As noted in Item 3, Keystone allows for a 10 minute trouble shoot period to confirm if the alarm is a pressure fluctuation or an actual leak. This time period was incorporated into Keystone XL's worst case discharge calculation in addition to the pump shut down time and valve closure time. Keystone's OCC procedures require immediate shut down of the pipeline upon expiry of the trouble shoot period. Stansbury's assumption of four alarms, five minutes apart, bears no relationship to Keystone operating policies and procedures.

- 18. TransCanada arbitrarily assigned a drain-down factor of 0.6 for the Keystone XL pipeline. Stansbury report at p. 9).**

Keystone's methodology incorporates the results of an independent assessment by the California Fire Marshal in its role as a regulator in California. The report is well known and respected among pipeline industry, regulators and risk assessors.

- 19. Stansbury assumes a discovery and shut-down time of 14 days, which corresponds to the time between pipeline inspections. Stansbury document at p. 20).**

Prepared By: Meera Kothari, Jesse Bajnok & Heidi Tillquist

See response to Item number 15.

**20. Stansbury states his estimated worst case releases for major river crossings (i) Missouri R.; (ii) Yellowstone R.; (ii) Platte R. (Stansbury document at pp.10-13).**

Stansbury's estimates for these major river crossings are grossly overstated. Based on actual elevation profile, spill calculation inputs and hydraulic engineering data the worst case discharges for these three rivers is less than 20 percent of the volumes stated by Stansbury.

**21. "Impacts to Air, Terrestrial Resources, Surface Water, Groundwater Resources (Stansbury document at pp. 14 – 23)**

Please refer to the Keystone XL Project Pipeline Risk Assessment and Environmental Consequence Analysis in April 2009.